



MODEL:

DRPC-242-ADL-P Series

Embedded system supports 12/13th Gen Intel® Alder Lake P and Raptor Lake on-board processor, dual-channel DDR4 SO-DIMMs, HDMI/DP, 3 x 2.5GbE LAN, 4 x COM, 6 x USB, 12~28V DC, RoHS

User Manual

Revision

Date	Version	Changes
Sept. 15, 2023	1.00	Initial release
April 01, 2024	1.01	Update model variations and optional cable
Dec. 09, 2024	1.02	Correction of the markings on Front panel with COM1 and COM2

Copyright

COPYRIGHT NOTICE

The information in this document is subject to change without prior notice in order to improve reliability, design and function and does not represent a commitment on the part of the manufacturer.

In no event will the manufacturer be liable for direct, indirect, special, incidental, or consequential damages arising out of the use or inability to use the product or documentation, even if advised of the possibility of such damages.

This document contains proprietary information protected by copyright. All rights are reserved. No part of this manual may be reproduced by any mechanical, electronic, or other means in any form without prior written permission of the manufacturer.

TRADEMARKS

All registered trademarks and product names mentioned herein are used for identification purposes only and may be trademarks and/or registered trademarks of their respective owners.

Manual Conventions



WARNING

Warnings appear where overlooked details may cause damage to the equipment or result in personal injury. Warnings should be taken seriously.



CAUTION

Cautionary messages should be heeded to help reduce the chance of losing data or damaging the product.



NOTE

These messages inform the reader of essential but non-critical information. These messages should be read carefully as any directions or instructions contained therein can help avoid making mistakes.



HOT SURFACE

This symbol indicates a hot surface that should not be touched without taking care.

Table of Content

1 INTRODUCTION.....	1
1.1 OVERVIEW.....	2
1.2 FEATURES.....	3
1.3 MODEL VARIATIONS	3
1.4 TECHNICAL SPECIFICATIONS	4
1.5 FRONT PANEL.....	6
1.6 TOP PANEL	7
1.7 RIGHT SIDE PANEL	8
1.8 PHYSICAL DIMENSIONS	9
2 UNPACKING	11
2.1 ANTI-STATIC PRECAUTIONS	12
2.2 UNPACKING PRECAUTIONS.....	12
2.3 UNPACKING CHECKLIST	13
3 INSTALLATION	16
3.1 INSTALLATION PRECAUTIONS	17
3.2 BACK COVER REMOVAL.....	18
3.3 HDD DISK BRACKET REMOVAL.....	18
3.4 MEMORY INSTALLATION.....	19
3.5 STORAGE INSTALLATION	20
3.5.1 2.5-inch SSD Installation.....	20
3.5.2 M.2 SSD Installation.....	21
3.6 WI-FI MODULE INSTALLATION (OPTIONAL).....	22
3.7 IO EXTENSION INSTALLATION (OPTIONAL).....	24
3.7.1 Serial Port Installation	24
3.7.2 GPIO Installation.....	25
3.8 EXPANSION CHASSIS INSTALLATION (OPTIONAL).....	26
3.9 BACK COVER INSTALLATION	28
3.10 SYSTEM FAN INSTALLATION (OPTIONAL).....	28

3.11 MOUNTING BRACKETS INSTALLATION.....	29
3.11.1 DIN-Rail Installation.....	29
3.11.2 Wall Mounting Installation.....	31
3.12 EXTERNAL PERIPHERAL INTERFACE CONNECTORS.....	33
3.12.1 HDMI/ DP Connector.....	33
3.12.2 LAN Connectors.....	33
3.13 POWER CONNECTOR.....	35
3.14 AVAILABLE DRIVERS	37
3.14.1 Driver Download	37
3.15 MAINTENANCE.....	39
3.15.1 Flash Descriptor Security Override Jumper.....	39
3.15.2 Clear CMOS Button.....	40
3.15.3 AT/ATX Power Mode Setting	41
4 SYSTEM MOTHERBOARD	43
4.1 OVERVIEW.....	44
4.1.1 Layout	44
4.2 PERIPHERAL INTERFACE CONNECTORS.....	45
4.2.1 RTC Battery Connector.....	46
4.2.2 SIM card Connector.....	48
4.2.3 Internal USB 2.0 Connectors.....	49
4.2.4 Fan Connector	50
4.2.5 Digital Input / Output Connector.....	51
4.2.6 M.2 M-key Slot.....	52
4.2.7 M.2 B-key Slot.....	54
4.2.8 M.2 A-key Slot.....	56
4.2.9 DDR4 SO-DIMM Socket.....	58
4.2.10 PCIe x4 Slot	59
4.2.11 RS-232 Serial Port Connector.....	60
4.2.12 12V Power Output Connector.....	61
4.2.13 SATA 6Gb/s Drive Connector	62
4.2.14 I ² C Connector	63
4.2.15 SMBus Connector	64
4.2.16 Flash SPI ROM Connector	65
4.2.17 Chassis Intrusion Connector.....	66

DRPC-242-ADL-P

4.2.18 Flash EC ROM Connector.....	67
4.2.19 EC Debug Connector.....	68
4.2.20 PMBUS Connector.....	69
4.3 EXTERNAL PERIPHERAL INTERFACE CONNECTOR PANEL	70
4.3.1 Power Switch	70
4.3.2 Reset Button Connector	72
4.3.3 HDMI Connectors.....	73
4.3.4 System Fan Connector	74
4.3.5 DP Connector	75
4.3.6 DB-9 RS-232/422/485 Serial Port Connectors.....	75
5 BIOS	77
5.1 INTRODUCTION.....	78
5.1.1 Starting Setup.....	78
5.1.2 Using Setup	79
5.1.2.1 Keyboard Navigation	79
5.1.2.2 Touch Navigation	80
5.1.3 Getting Help.....	81
5.1.4 Unable to Reboot after Configuration Changes	81
5.1.5 BIOS Menu Bar.....	81
5.2 MAIN.....	82
5.3 ADVANCED.....	85
5.3.1 CPU Configuration.....	87
5.3.2 AMT Configuration	91
5.3.3 Trusted Computing.....	92
5.3.4 RTC Wake Settings	93
5.3.5 F81966 Super IO Configuration.....	94
5.3.5.1 Serial Port 1 Configuration	95
5.3.5.2 Serial Port 2 Configuration	96
5.3.5.3 Serial Port 3 Configuration	97
5.3.5.4 Serial Port 4 Configuration	98
5.3.5.5 Serial Port 5 Configuration	99
5.3.5.6 Serial Port 6 Configuration	100
5.3.6 EC KB9068 H/W Monitor.....	101
5.3.6.1 Smart Fan Mode Configuration	103

5.3.7 Serial Port Console Redirection	106
5.3.7.1 Console Redirection Settings	108
5.3.8 NVMe Configuration.....	111
5.4 CHIPSET	112
5.4.1 System Agent (SA) Configuration	113
5.4.1.1 Memory Configuration	114
5.4.1.2 Graphics Configuration.....	115
5.4.1.3 VMD setup menu (RAID Mode)	116
5.4.1.4 PEG Port Configuration	117
5.4.1.4.1 M2_M1	118
5.4.1.4.2 PCIEX4_1 Slot.....	119
5.4.2 PCH-IO Configuration	121
5.4.2.1 PCI Express Configuration	124
5.4.2.1.1 PCI Express Root Port Setting	125
5.4.2.2 SATA Configuration.....	127
5.4.2.3 HD Audio Configuration.....	128
5.5 SECURITY.....	129
5.6 BOOT.....	131
5.6.1 Boot Configuration	131
5.7 SAVE & EXIT	132
A SAFETY PRECAUTIONS	134
A.1 SAFETY PRECAUTIONS	135
A.1.1 General Safety Precautions	135
A.1.2 Anti-static Precautions	136
A.1.3 Product Disposal	137
A.2 MAINTENANCE AND CLEANING PRECAUTIONS	138
A.2.1 Maintenance and Cleaning.....	138
A.2.2 Cleaning Tools.....	138
B REGULATORY COMPLIANCE	140
C BIOS MENU OPTIONS.....	145
D HAZARDOUS MATERIALS DISCLOSURE	149
D.1 RoHS II DIRECTIVE (2015/863/EU)	150
D.2 CHINA RoHS.....	151

List of Figures

Figure 1-1: DRPC-242-ADL-P Series	2
Figure 1-2: Front Panel	6
Figure 1-3: back Panel	7
Figure 1-4: DRPC-242-ADL-P Right Side Panel	8
Figure 1-5: Physical Dimensions	9
Figure 1-6: DRPC-242-ADL-P Dimensions	10
Figure 3-1: Remove the Cover	18
Figure 3-2: Removing the HDD Bracket	19
Figure 3-3: Memory Installation	20
Figure 3-4: HDD Installation	21
Figure 3-5: Inserting the M.2 Module into the Slot at an Angle.....	21
Figure 3-6: Securing the M.2 Module.....	22
Figure 3-7: Inserting the WLAN Module	22
Figure 3-8: Securing the WLAN Module.....	23
Figure 3-9: Connecting RF Cables.....	23
Figure 3-10: Securing SMA Connector and External Antenna Installation	24
Figure 3-11: RS-232 Cable Installation	24
Figure 3-12: RS-232 DB9 Cable Installation.....	25
Figure 3-13: Connect the GPIO cable to the GPIO connector.....	25
Figure 3-14: Knock out the reserved holes.....	26
Figure 3-15: Expansion Chassis Installation	27
Figure 3-16: Back Cover Installation	28
Figure 3-17: External Fan Module Installation.....	29
Figure 3-18: Align the retention screw holes.....	30
Figure 3-19: DIN Rail Mounting Bracket Installation.....	30
Figure 3-20: Mounting the system	31
Figure 3-21: Align the retention screw holes.....	32
Figure 3-22: Mounting Bracket Retention Screw	32
Figure 3-23: Mounting the system	32
Figure 3-24: HDMI/DP Connection	33

Figure 3-25: LAN Connection	34
Figure 3-26: RJ-45 Ethernet Connector	34
Figure 3-27: Power Connector	35
Figure 3-28: Power & HDD LED	36
Figure 3-29: ME Override Setting Jumper Locations	39
Figure 3-30: Clear CMOS Location	41
Figure 3-31: AT/ATX Power Mode Setting Location	42
Figure 4-1: Connector and Jumper Locations	44
Figure 4-2: System Motherboard (Rear)	45
Figure 4-3: Battery Connector Location	47
Figure 4-4: SIM card Connector Locations	48
Figure 4-5: Internal USB 2.0 Connectors Locations	49
Figure 4-6: Fan Connector Location	50
Figure 4-7: Digital I/O Connector Location	51
Figure 4-8: M.2 M-key Slot Location	52
Figure 4-9: M.2 B-key Slot Location	54
Figure 4-10: M.2 A-key Slot Location	56
Figure 4-11: DDR4 SO-DIMM Socket Location	58
Figure 4-12: PCIe x4 Slot Location	59
Figure 4-13: RS-232 Serial Port Connector Location	60
Figure 4-14: 12V Power Output Connector Location	61
Figure 4-15: SATA 6Gb/s Drive Connectors Location	62
Figure 4-16: I ² C Connector Location	63
Figure 4-17: SMBus Connector Location	64
Figure 4-18: Flash SPI ROM Connector Location	65
Figure 4-19: Chassis Intrusion Connector Location	66
Figure 4-20: Flash EC ROM Connector Location	67
Figure 4-21: EC Debug Connector Location	68
Figure 4-22: PMBUS Connector Location	69
Figure 4-23: Power Switch Location	71
Figure 4-24: Reset Button Connector Location	72
Figure 4-25: HDMI Connector Pinout Locations	73
Figure 4-26: System Fan Connector Pinout Locations	74
Figure 4-27: DP Connector Pinout Locations	75
Figure 4-28: DB-9 RS-232/422/485 Serial Port Connectors Locations	76

DRPC-242-ADL-P

Figure 5-1: BIOS Starting Menu	78
Figure 5-2: BIOS Navigation Keys	79
Figure 5-3: BIOS On-screen Navigation Keys	80

List of Tables

Table 1-1: Model Variations of DRPC-242-ADL-P	3
Table 1-2: Technical Specifications	5
Table 3-1: RJ-45 Ethernet Connector LEDs	34
Table 3-2: ME Override Setting Jumper Pinouts	40
Table 3-3: Clear CMOS Pinouts	41
Table 4-1: Internal Peripheral Connectors	46
Table 4-2: Battery Connector Pinouts	47
Table 4-3: SIM Card Connector Pinouts	48
Table 4-4: Internal USB 2.0 Connectors Pinouts	50
Table 4-5: Fan Connector Pinouts	51
Table 4-6: Digital I/O Connector Pinouts	52
Table 4-7: M.2 M-key Slot Pinouts	54
Table 4-8: M.2 B-Key Slot Pinouts	55
Table 4-9: M.2 A-Key Slot Pinouts	57
Table 4-10: RS-232 Serial Port Connector Pinouts	60
Table 4-11: 12V Power Input Connector Pinouts	61
Table 4-12: SATA 6Gb/s Drive Connector Pinouts	63
Table 4-13: I ² C Connector Pinouts	64
Table 4-14: SMBus Connector Pinouts	65
Table 4-15: Flash SPI ROM Connector Pinouts	66
Table 4-16: Chassis Intrusion Connector Pinouts	66
Table 4-17: Flash EC ROM Connector Pinouts	67
Table 4-18: EC Debug Connector Pinouts	68
Table 4-19: PMBUS Connector Pinouts	69
Table 4-20: Rear Panel Connectors	70
Table 4-21: Reset Button Connector Pinouts	72
Table 4-22: HDMI Connector Pinouts	73
Table 4-23: System Fan Connector Pinouts (FAN2)	74
Table 4-24: DP Connector Pinouts	75
Table 4-25: RS-232 (COM1/1) & RS-422/485 (COM3/1) Connector Pinouts	76

DRPC-242-ADL-P

Table 5-1: BIOS Options and Configured USB Ports.....123

BIOS Menu

BIOS Menu 1: Main (1/2).....	82
BIOS Menu 2: Main (2/2).....	82
BIOS Menu 3: Advanced (1/2).....	86
BIOS Menu 4: Advanced (2/2).....	86
BIOS Menu 5: CPU Configuration (1/3).....	87
BIOS Menu 6: CPU Configuration (2/3).....	87
BIOS Menu 7: CPU Configuration (3/3).....	88
BIOS Menu 8:AMT Configuration	91
BIOS Menu 9: Trusted Computing	92
BIOS Menu 10: RTC Wake Settings	93
BIOS Menu 11: F81966 Super IO Configuration	94
BIOS Menu 12: Serial Port 1 Configuration Menu	95
BIOS Menu 13: Serial Port 2 Configuration Menu	96
BIOS Menu 14: Serial Port 3 Configuration Menu	97
BIOS Menu 15: Serial Port 4 Configuration Menu	98
BIOS Menu 16: Serial Port 5 Configuration Menu	99
BIOS Menu 17: Serial Port 6 Configuration Menu	100
BIOS Menu 18: EC KB9068 H/W Monitor.....	101
BIOS Menu 19: Smart Fan Mode Configuration (1/2).....	103
BIOS Menu 20: Smart Fan Mode Configuration (2/2).....	103
BIOS Menu 21: Serial Port Console Redirection (1/3).....	106
BIOS Menu 22: Serial Port Console Redirection (2/3).....	107
BIOS Menu 23: Serial Port Console Redirection (3/3).....	107
BIOS Menu 24: COM Console Redirection Settings	108
BIOS Menu 25: NVMe Configuration.....	111
BIOS Menu 26: Chipset	112
BIOS Menu 27: System Agent (SA) Configuration	113
BIOS Menu 28: Memory Configuration.....	114
BIOS Menu 29: Graphics Configuration	115
BIOS Menu 30: VMD setup menu (RAID Mode)	116

DRPC-242-ADL-P

BIOS Menu 31: PEG Port Configuration.....	117
BIOS Menu 32: M2_M1	118
BIOS Menu 33: PCIEX4_1 Slot.....	119
BIOS Menu 34: PCI-IO Configuration (1/2)	121
BIOS Menu 35: PCI-IO Configuration (2/2)	121
BIOS Menu 36: PCI Express Configuration	124
BIOS Menu 37: PCI Express Root Port Settings	125
BIOS Menu 38: SATA Configuration.....	127
BIOS Menu 39: HD Audio Configuration	128
BIOS Menu 40: Security (1/2).....	129
BIOS Menu 41: Security (2/2).....	129
BIOS Menu 42: Boot	131
BIOS Menu 43: Save & Exit.....	132

Chapter

1

Introduction

1.1 Overview



Figure 1-1: DRPC-242-ADL-P Series

The DRPC-242-ADL-P Series is an embedded system with Intel® Alder Lake P or Raptor Lake processor and two DDR4 SO-DIMM memory (8GB pre-installed). It is designed for harsh environment applications, and supports DIN rail mounting method.

The DRPC-242-ADL-P Series accepts a wide range of DC power input (12V ~ 28V), allowing it to be powered anywhere. It is equipped with two USB 3.2 Gen2 (10Gb/s), four USB 2.0, three 2.5GbE, two isolation RS-232 ports, two isolation RS-422/485 ports, one HDMI and one DisplayPort++ to provide rich I/O options for various applications. Two RS-232 and two USB 2.0 are reserved inside for expansion

Furthermore, the DRPC-242-ADL-P also has a PCIe x4 slot that can support half-size expansion cards

DRPC-242-ADL-P

1.2 Features

The DRPC-242-ADL-P Series features are listed below:

- Intel® Alder Lake P and Raptor Lake processor
- 2 x DDR4 SO-DIMM memory slot (8GB pre-installed)
- 1 x 2.5" SATA 6Gb/s HDD/SSD bay
- 2 x USB 3.2 Gen2 (10Gb/s) port
- 4 x USB 2.0 port
- 3 x 2.5GbE LAN
- 2 x isolation RS232 & 2 x isolation RS422/485
- Support M.2 M Key, M.2 A key and M.2 B key expansions
- Wide range DC power input (12V~28V)
- Cold forging heat dissipation
- PCIe x4 slot expansion (optional)
- DIN rail mounting support
- RoHS compliant

1.3 Model Variations

Model No.	CPU
DRPC-242-ADL-P-CCS	Intel® Celeron® 7305 (5-core, 15W TDP)
DRPC-242-ADL-P-i3CS	Intel® Core™ i3-1220P (up to 4.4GHz, 10-core, 28W TDP)
DRPC-242-ADL-P-Ri3ECS	Intel® Core™ i3-1320PE (up to 4.5GHz, 8-core, 28W TDP)
DRPC-242-ADL-P-i5CS	Intel® Core™ i5-1240P (up to 4.4GHz, 12-core, 28W TDP)
DRPC-242-ADL-P-Ri5ECS	Intel® Core™ i5-1340PE (up to 4.5GHz, 12-core, 28W TDP)
DRPC-242-ADL-P-i7CS	Intel® Core™ i7-1260P (up to 4.7GHz, 12-core, 28W TDP)
DRPC-242-ADL-P-Ri7ECS	Intel® Core™ i7-1370PE (up to 4.8GHz, 14-core, 28W TDP)

Table 1-1: Model Variations of DRPC-242-ADL-P

1.4 Technical Specifications

The DRPC-242-ADL-P Series technical specifications are listed in (Table 1-2)

Model name		DRPC-242-ADL-P-CCS	DRPC-242-ADL-P-i3CS	DRPC-242-ADL-P-i5CS	DRPC-242-ADL-P-i7CS
Chassis	Dimensions	81 x 150 x190			
	System fan	Fanless (Fan optional)			
	Chassis Construction	Extruded Aluminum alloys			
Motherboard	CPU	Intel® Celeron® 7305 (5-core, 15W TDP)	Intel® Core™ i3-1220P (up to 4.4GHz, 10-core, 28W TDP)	Intel® Core™ i5-1240P (up to 4.4GHz, 12-core, 28W TDP)	Intel® Core™ i7-1260P (up to 4.7GHz, 12-core, 28W TDP)
	Chipset	SoC			
	System Memory	2 x SO-DIMM slot DDR4 3200 MHz (8 GB pre-installed) (up to 64GB)			
Storage	Hard drive	1 x 2.5" SATA 6Gb/s SSD bay			
I/O Interfaces	USB	2 x USB3.2 Gen2			
		4 x USB2.0			
	Ethernet	1 x 2.5GbE by Intel® I225LM support iAMT			
		2 x 2.5GbE by Intel® I225V (colay I225LM)			
	COM	2 x RS-232 (DB9 with 2.5KV isolation)			
		2 x RS-232 (optional)			
		2 x RS-422/485 with AFC (DB9 with 2.5KV isolation)			
	DIO	1 x 12-bit (6-in,6-out) (optional)			
	Display	1 x lockable HDMI 1.4b (up to 4096 x 2160@30Hz)			
		1 x DP 1.4b (up to 4096 x 2160 @60Hz)			
TPM	Support Intel PTT				
Others	1 x Power button, 1 x 2-pin terminal block for Remote Power Button, 1 x Reset button, 1 x AT/ATX switch, 1 x Power LED (green), 1 x HDD LED (yellow), 1 x 4-pin external system fan connector				
Expansions	M.2	1 x 2230 A-key (PCIe Gen3 x1/ USB2.0) Support Vpro			
		1 x 3042/52 B-key (PCIe Gen3 x1/ USB3.2 Gen2/ USB2.0) with SIM card			

DRPC-242-ADL-P

		1 x 2280 M-key (PCIe Gen4 x4)
	Backplane	1 x PCIe Gen3 x4 (optional)
Power	Power input	3-pin terminal block: 12~28 VDC
	Internal PWR	4-pin 60w @12V
	Consumption	12V@4.46A (Intel © Core™ i7-1260P with DDR4 8G Memory)
Reliability	Mounting	DIN-rail
	Operating Temp	-20°C ~ 60°C with air flow (SSD)
	Storage Temp	-40°C ~ 85°C
	Humidity	10% ~ 95%, non-condensing
	Operating shock	Half-sine wave shock 5G, 11ms, 3 shocks per axis (SSD)
	Operating vibration	10-500 Hz, 1.04 Grms, random, 1 hr/axis (SSD)
	Weight	1.88 / 2.66KG
	Safety/EMC	CE, FCC, UKCA
OS	Supported OS	Microsoft © Windows 10 / Windows 11, Linux

Table 1-2: Technical Specifications

1.5 Front Panel

The front panel of the DRPC-242-ADL-P Series has the following features.

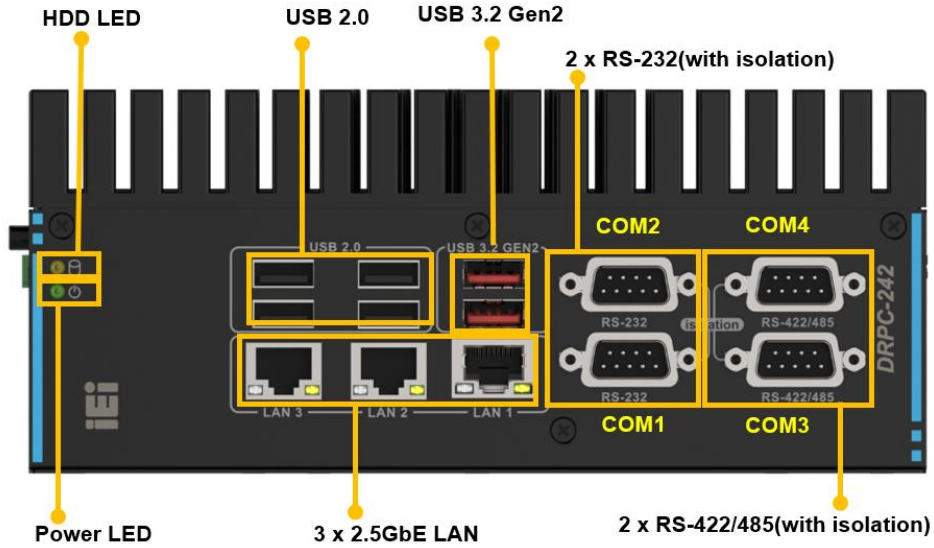

Figure 1-2: Front Panel

DRPC-242-ADL-P

1.6 Top Panel

The top panel of the DRPC-242-ADL-P Series is shown below.

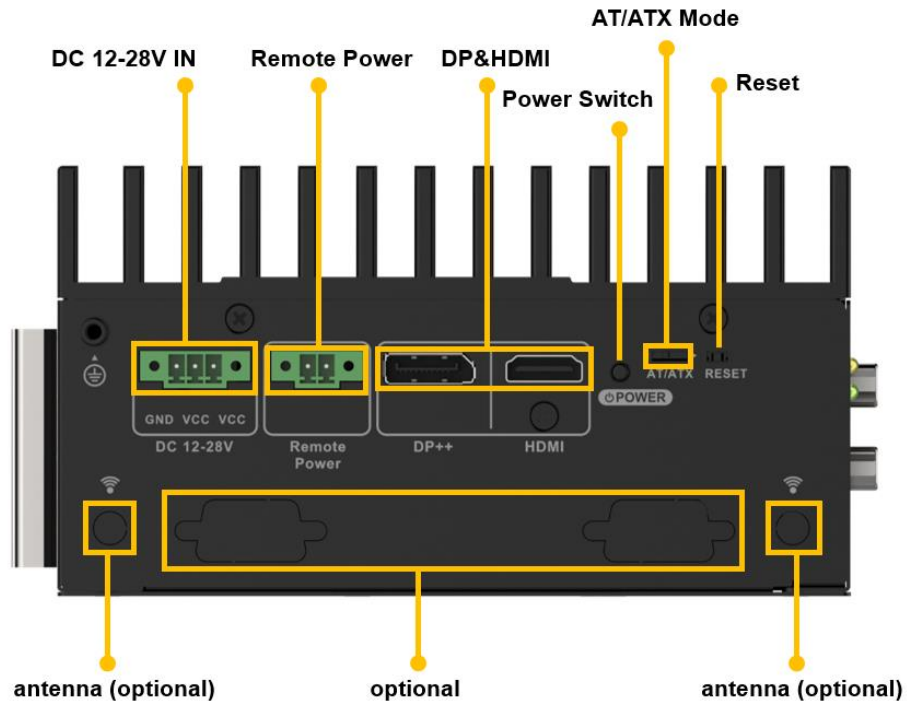

Figure 1-3: back Panel

1.7 Right Side Panel

The DRPC-242-ADL-P Series' right side panel contains one system fan connector.

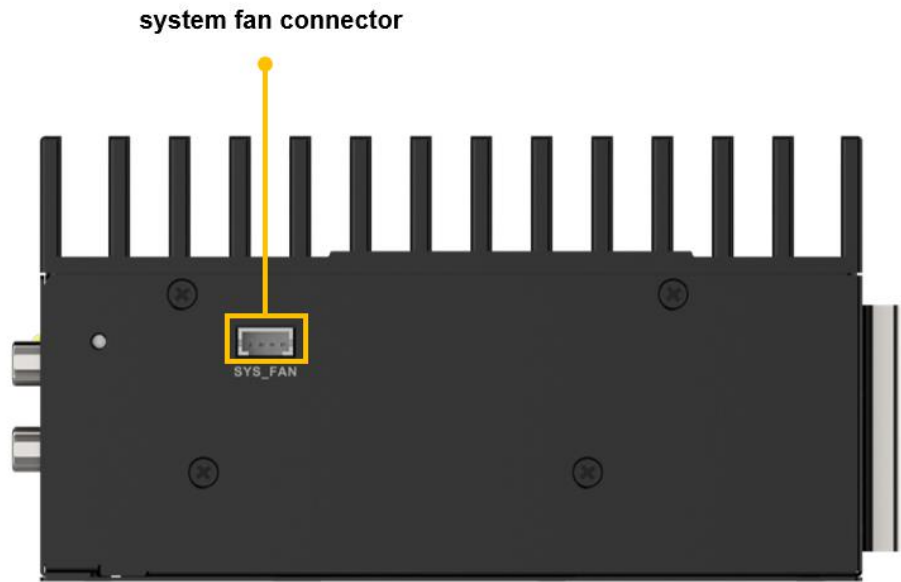

Figure 1-4: DRPC-242-ADL-P Right Side Panel

DRPC-242-ADL-P

1.8 Physical Dimensions

The physical dimensions of the DRPC-242-ADL-P Series are shown in (Figure 1-5).

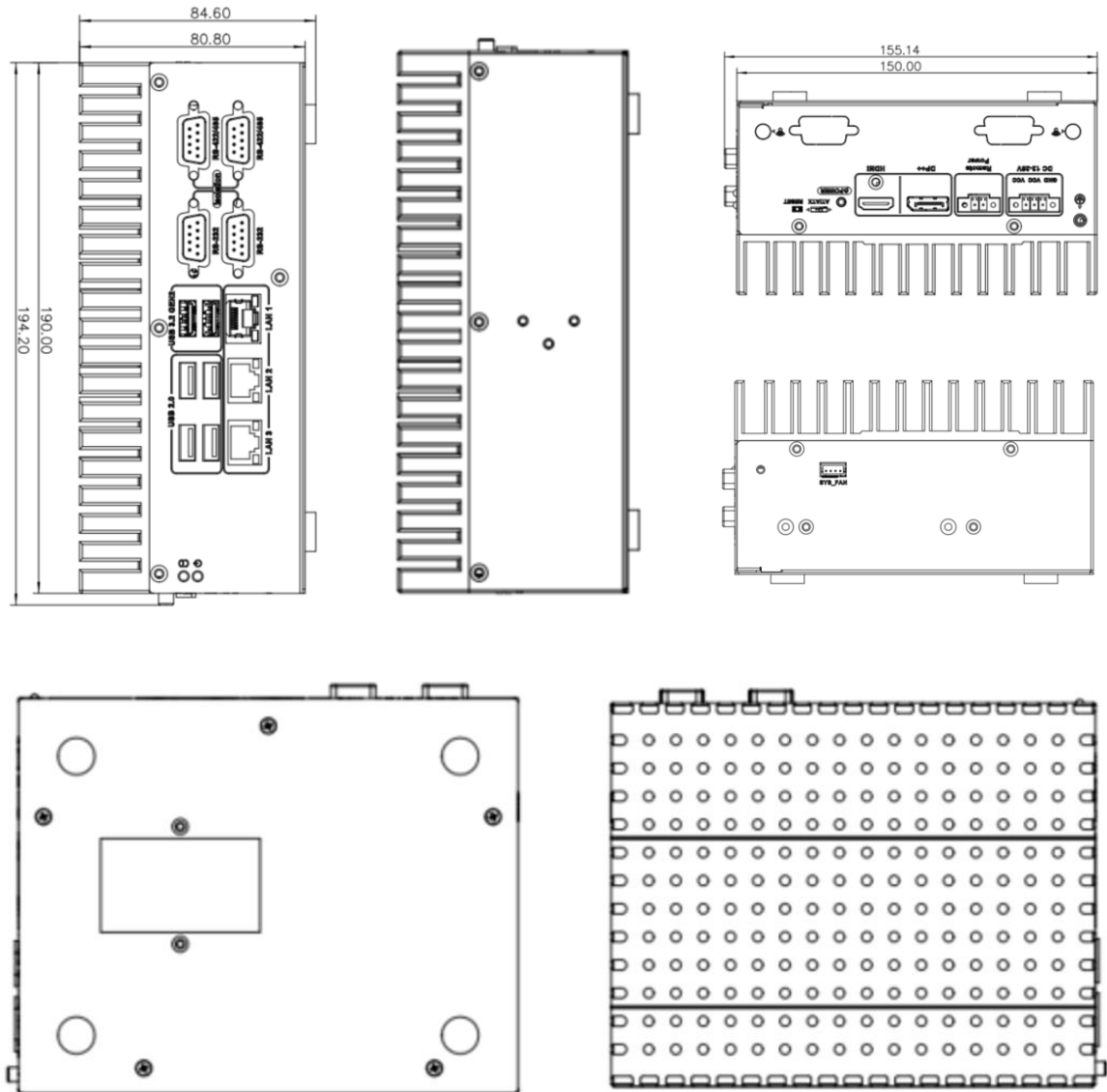

Figure 1-5: Physical Dimensions

With expansion layer Dimensions

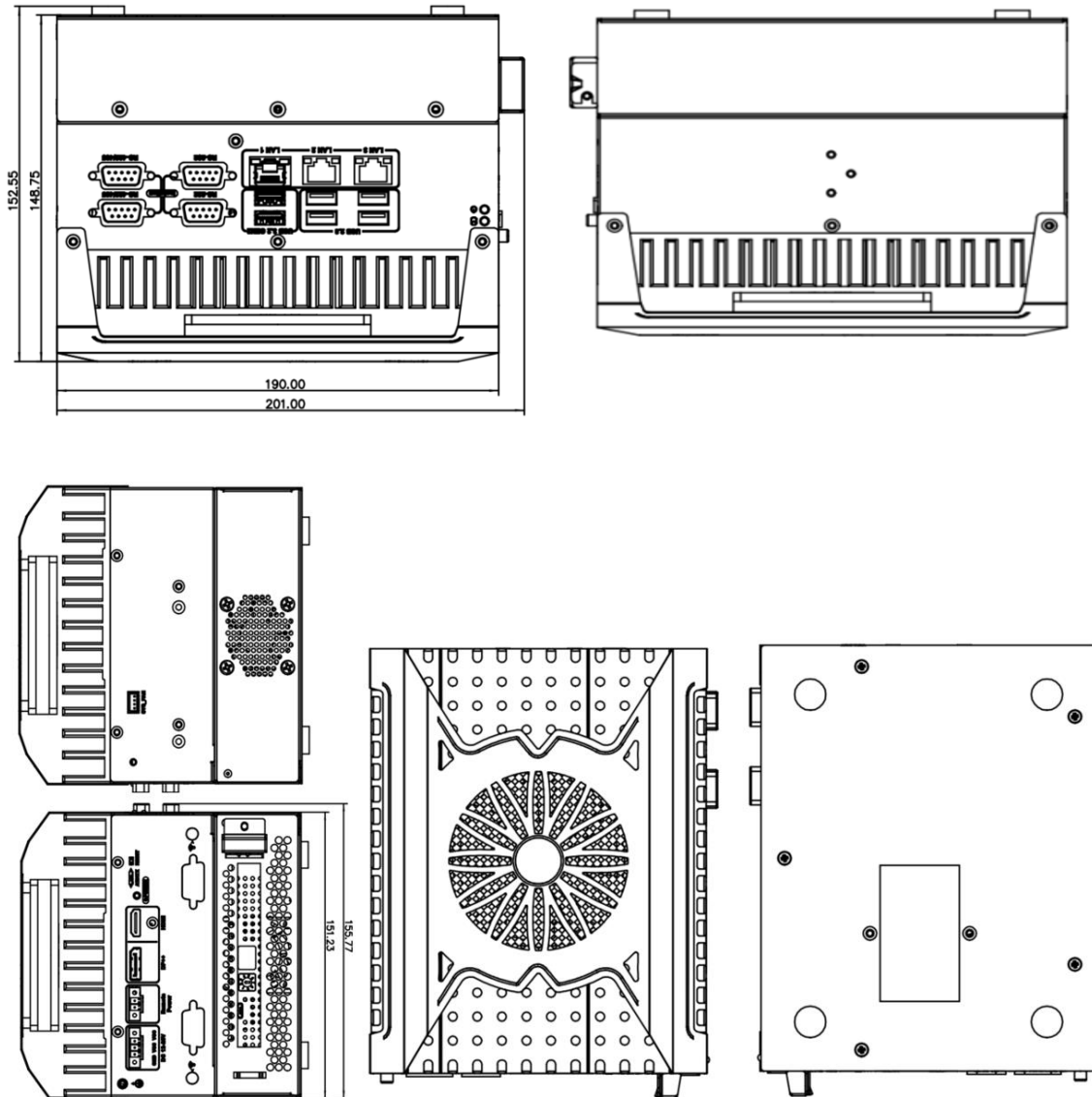

Figure 1-6: DRPC-242-ADL-P Dimensions

Chapter

2

Unpacking

2.1 Anti-static Precautions



WARNING:

Failure to take ESD precautions during installation may result in permanent damage to the DRPC-242-ADL-P Series and severe injury to the user.

Electrostatic discharge (ESD) can cause serious damage to electronic components, including the DRPC-242-ADL-P Series. Dry climates are especially susceptible to ESD. It is therefore critical that whenever the DRPC-242-ADL-P Series or any other electrical component is handled, the following anti-static precautions are strictly adhered to.

- **Wear an anti-static wristband:** Wearing a simple anti-static wristband can help to prevent ESD from damaging the board.
- **Self-grounding:** Before handling the board touch any grounded conducting material. During the time the board is handled, frequently touch any conducting materials that are connected to the ground.
- **Use an anti-static pad:** When configuring the DRPC-242-ADL-P Series, place it on an anti-static pad. This reduces the possibility of ESD damaging the DRPC-242-ADL-P Series.

2.2 Unpacking Precautions

When the DRPC-242-ADL-P Series is unpacked, please do the following:

- Follow the anti-static precautions outlined in **Section 2.1**.
- Make sure the packing box is facing upwards that the DRPC-242-ADL-P Series does not fall out of the box.
- Make sure all the components shown in **Section 2.2** are present.



DRPC-242-ADL-P

2.3 Unpacking Checklist







 **NOTE:**

If some of the components listed in the checklist below are missing, please do not proceed with the installation. Contact the IEI reseller or vendor you purchased the DRPC-242-ADL-P Series from or contact an IEI sales representative directly. To contact an IEI sales representative, please send an email to sales@ieiworld.com.

The DRPC-242-ADL-P Series is shipped with the following components:

Standard		
Quantity	Item and Part Number	Image
1	DRPC-242-ADL-P Series	
2	DIN-Rail mounting kit	
1	Chassis screws	

The following table lists the optional items that can be purchased separately.

Optional	
Wi-Fi module (P/N: EMB-WIFI-KIT02I3-R10)	
DIO cable (P/N: 32031-000600-100-RS)	
DC power conversion cable (P/N: 32102-054800-100-RS)	
Serial cable (P/N: 32205-005401-100-RS)	
Power adapter (120W) (P/N: 63040-010120-300-RS)	
Power adapter (180W) (P/N: 63040-010180-200-RS)	

DRPC-242-ADL-P

Optional	
Power cord (P/N: 32702-000200-100-RS)	
Wall mount brackets (P/N: 41020-0578C2-00-HF*2)	
1-slot expansion chassis with riser card (P/N: TXC-DRPC-240-1S-R10)	
External fan module (P/N: SF-DRPC-240-R10)	

** Each Wi-Fi module needs two antennas and two RF cables to fully support Wi-Fi function.*

Chapter

3

Installation

3.1 Installation Precautions

**CAUTION:**

The DRPC-242-ADL-P Series has more than one power supply connection point.

To reduce the risk of electric shock, disconnect all power sources before installing or servicing the DRPC-242-ADL-P Series.

During installation, be aware of the precautions below:

- **Read the user manual:** The user manual provides a complete description of the DRPC-242-ADL-P Series, installation instructions and configuration options.
- **DANGER! Disconnect Power:** Power to the DRPC-242-ADL-P Series must be disconnected during the installation process, or before any attempt is made to access the rear panel. Electric shock and personal injury might occur if the rear panel of the DRPC-242-ADL-P Series is opened while the power cord is still connected to an electrical outlet.
- **Qualified Personnel:** The DRPC-242-ADL-P Series must be installed and operated only by trained and qualified personnel. Maintenance, upgrades, or repairs may only be carried out by qualified personnel who are familiar with the associated dangers.
- **Air Circulation:** Make sure there is sufficient air circulation when installing the DRPC-242-ADL-P Series. The DRPC-242-ADL-P Series' cooling vents must not be obstructed by any objects. Blocking the vents can cause overheating of the DRPC-242-ADL-P Series. Leave at least 5 cm of clearance around the DRPC-242-ADL-P Series to prevent overheating.
- **Grounding:** The DRPC-242-ADL-P Series should be properly grounded. The voltage feeds must not be overloaded. Adjust the cabling and provide external overcharge protection per the electrical values indicated on the label attached to the back of the DRPC-242-ADL-P Series.

3.2 Back Cover Removal

Before installing or maintaining the internal components, the cover must be removed from the DRPC-242-ADL-P Series. Follow the steps below to complete the task.

Step 1: Loosen the 5 screws on the top cover.

Step 2: Take off the back cover (Figure 3-1).

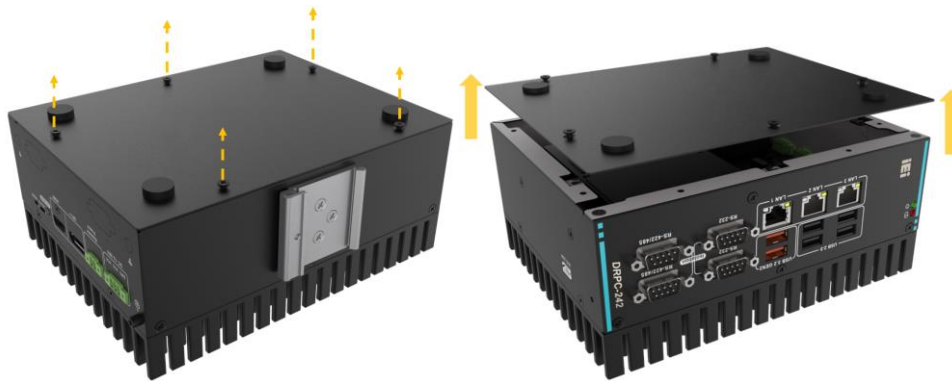

Figure 3-1: Remove the Cover

3.3 HDD Disk Bracket Removal

The HDD bracket must be removed first before installing a hard disk or M.2 modules.

Step 1: Remove the 3 screws on the side panels.

Step 2: Remove the HDD bracket as indicated by the arrows in Figure 3-2.

DRPC-242-ADL-P

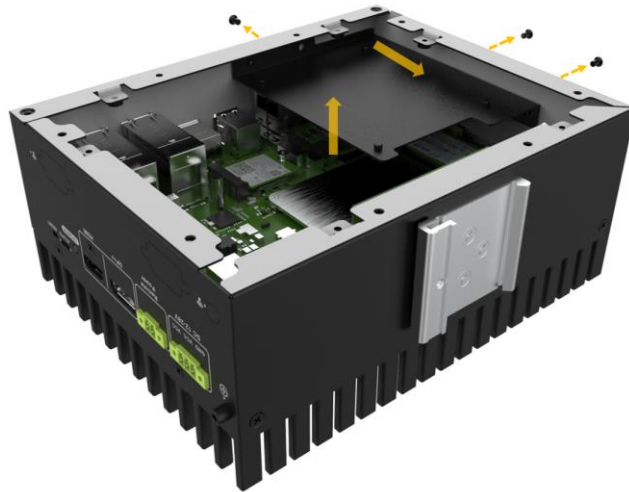

Figure 3-2: Removing the HDD Bracket

3.4 Memory Installation

The DRPC-242-ADL-P Series is pre-installed with an 8GB memory module. Users can add or replace memory with different capacity by themselves, the installation procedures are described below.

Step 1: Open the two handles of the memory slot.

Step 2: Remove the old memory module and insert a new memory module. Carefully align the memory module so the notch on the memory lines up with the notch on the memory socket.

Step 3: Once aligned, press down until the memory module is properly seated and the two handles fully clip into place (Figure 3-3).

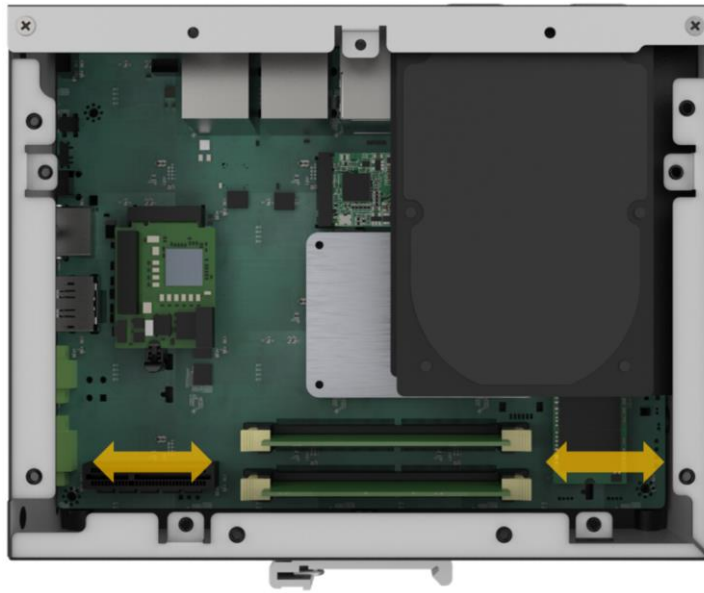

Figure 3-3: Memory Installation

3.5 Storage Installation

The DRPC-242-ADL-P Series supports two types of storage, one M.2 M Key & one 2.5" SSD. Before installing a M.2 SSD or 2.5" SSD/HDD, please follow the steps described in **Section 3.3** to remove the HDD bracket.

3.5.1 2.5-inch SSD Installation

- Step 1:** Place the HDD bracket onto the rear of the 2.5-inch hard disk. Fasten 4 screws to secure it.
- Step 2:** Plug in the hard drive cable, and install the HDD bracket back into the DRPC-242-ADL-P Series (pay attention to the positioning stud) using 3 screws (Figure 3-4).

DRPC-242-ADL-P

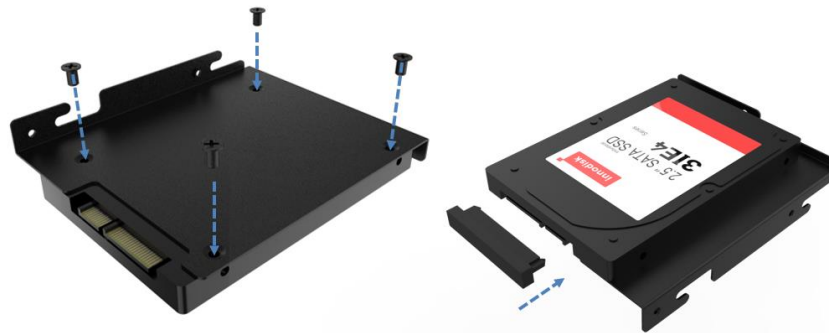

Figure 3-4: HDD Installation

3.5.2 M.2 SSD Installation

To install an M.2 B Key NVME, please follow the steps below.

Step 1: Locate the M.2 module slot. See [section 4.2.6](#)

Step 2: Remove the retention screw secured on the motherboard.

Step 3: Line up the notch on the module with the notch on the slot. Slide the M.2 module into the socket at an angle of about 20° (**Figure 3-5**).

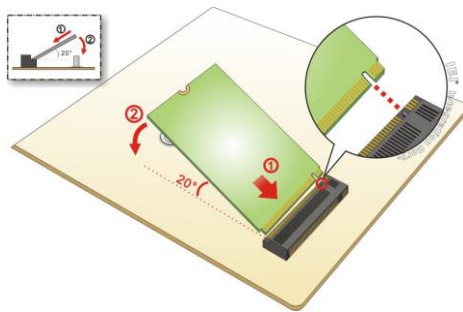

Figure 3-5: Inserting the M.2 Module into the Slot at an Angle

Step 4: Secure the M.2 module with the previously removed retention screw (**Figure 3-6**).

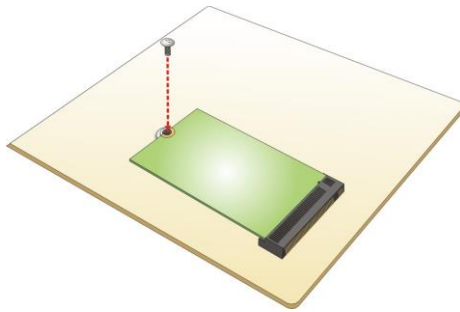

Figure 3-6: Securing the M.2 Module

3.6 Wi-Fi Module Installation (Optional)

The Wi-Fi module is an optional accessory. You can purchase it from IEI or other providers. Note that you have to purchase Wi-Fi module, internal antenna and external antenna. It is suggested to purchase an internal antenna longer than 200mm.

To install the Wi-Fi module, follow the steps below.

- Step 1:** Locate the M.2 A Key module slot. See **section 4.2.8**
- Step 2:** Remove the retention screw secured on the motherboard.
- Step 3:** Line up the notch on the WLAN module with the notch on the slot. Slide the WLAN module into the slot at an angle of about 20° (**Figure 3-7**).

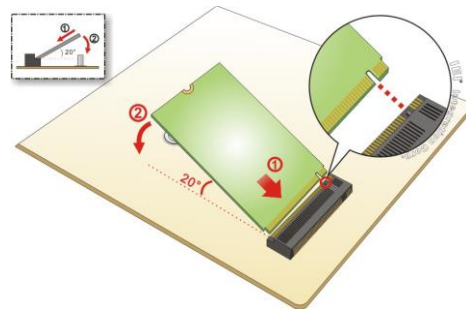

Figure 3-7: Inserting the WLAN Module

- Step 4:** Secure the WLAN module with the retention screw previously removed (**Figure 3-8**).

DRPC-242-ADL-P

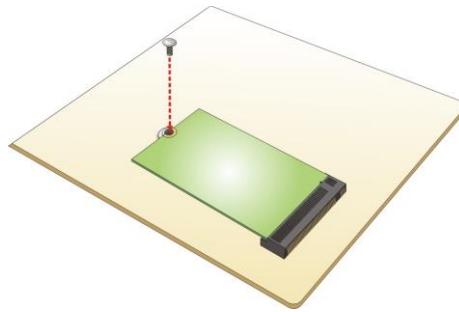

Figure 3-8: Securing the WLAN Module

Step 5: Connect the two RF cables to the antenna connectors on the WLAN module (Figure 3-9).

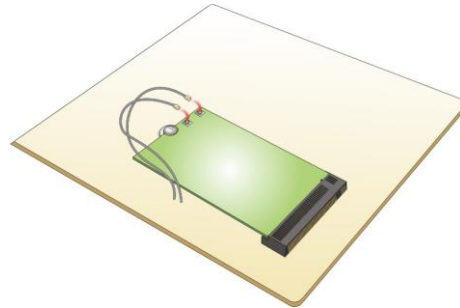

Figure 3-9: Connecting RF Cables

Step 6: Remove the nut and washer from the SMA connector at the other end of the RF cable.

Step 7: Knock out the reserved antenna holes on the chassis. Insert the SMA connector to the antenna connector holes on the rear panel.

Step 8: Secure the SMA connector by inserting the washer and tightening it with nut.

Step 9: Install the external antenna (Figure 3-10).

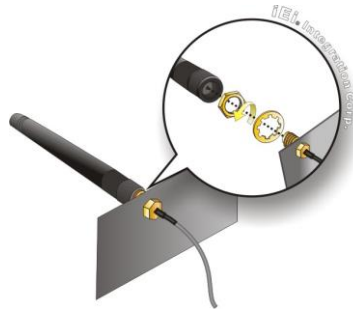

Figure 3-10: Securing SMA Connector and External Antenna Installation

3.7 IO extension Installation (Optional)

DRPC-242-ADL-P series products has reserved GPIO port, serial port, iDPM slot for function expansions. Optional cable or module are ready for purchase. To install these expansion components, follow the steps below.

3.7.1 Serial Port Installation

Step 1: Locate the Serial port connector. See Section

Step 2: Connect the serial cable to the serial connector on the mainboard. **(Figure 3-11)**

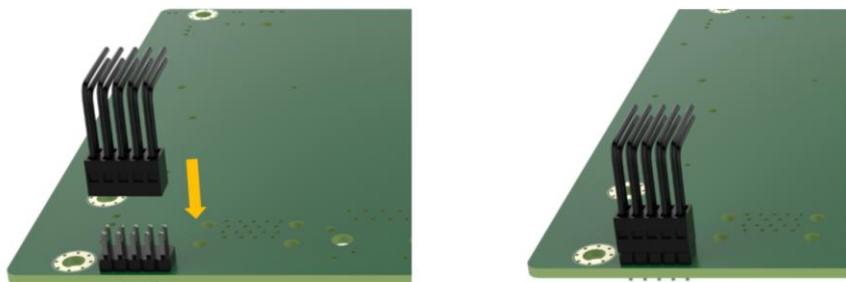

Figure 3-11: RS-232 Cable Installation

Step 3: Knock out the reserved holes on the chassis and Secure the DB9 end of the serial cable to the panel. **(Figure 3-12)**

DRPC-242-ADL-P

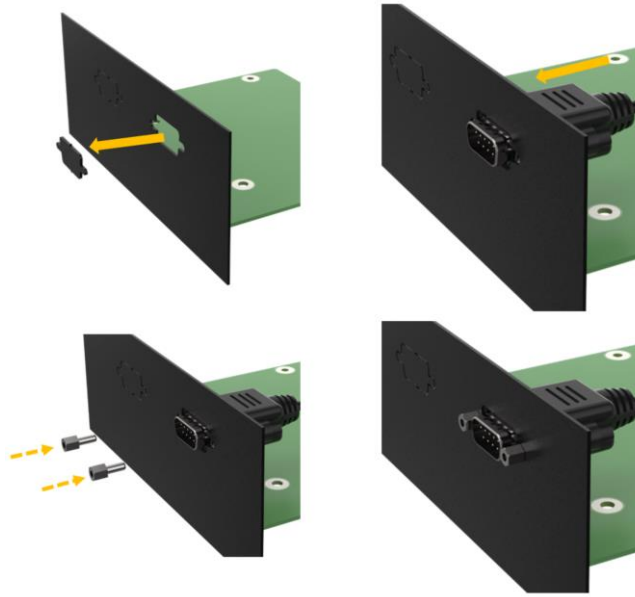

Figure 3-12: RS-232 DB9 Cable Installation

3.7.2 GPIO Installation

Step 1: Locate the GPIO port connector.

Step 2: Connect the GPIO cable to the GPIO connector on the mainboard.

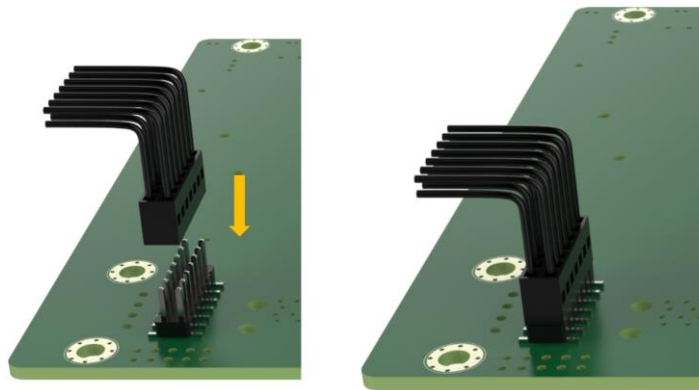

Figure 3-13: Connect the GPIO cable to the GPIO connector

Step 3: Knock out the reserved holes on the chassis and Secure the DB15 end of the GPIO cable to the panel.



Figure 3-14: Knock out the reserved holes

3.8 Expansion Chassis Installation (Optional)

The **DRPC-242-ADL-P** provides an option for adding PCIe x4 function, which is achieved by installing the expansion chassis (P/N: TXC-DRPC-240-1S-R10). The installation steps are described below.

- Step 1:** Before installing the expansion chassis, ensure the fan wire inside the system will not be pressed or damaged (adjust the wiring if necessary). Align the riser card on the expansion chassis with the PCIe x4 slot inside the DRPC-242.
- Step 2:** Once aligned, insert the riser card into the PCIe slot. Secure the expansion chassis with 8 screws.
- Step 3:** To install an expansion card, open the cover on the top cover of the expansion chassis by removing 6 screws. Remove the blank bracket and install the PCIe card. Reinstall the bracket screw and the top cover after installing the card (Figure 3-15).

DRPC-242-ADL-P

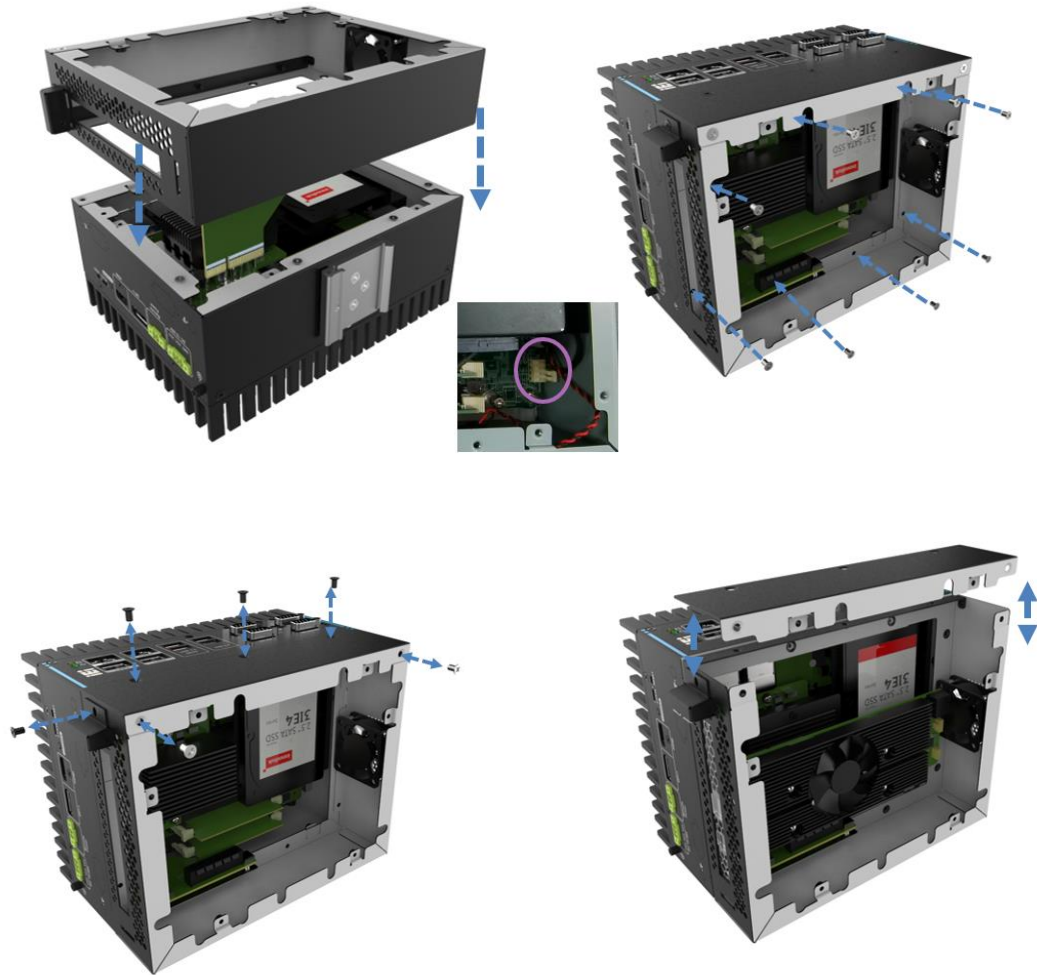

Figure 3-15: Expansion Chassis Installation

3.9 Back Cover Installation

Install the back cover, and fasten the 5 screws on the side.



Figure 3-16: Back Cover Installation

3.10 System Fan Installation (Optional)

When encountering high performance and high heat, additional cooling was needed. The optional external fan can help the DRPC-242-ADL-P Series solve the thermal problem.

To install the optional external fan, follow the steps below.

- Step 1:** Remove the 4 screws (2 on the front panel, 2 on the rear panel) on the DRPC-242-ADL-P Series as shown in the figure below.
- Step 2:** Install the expansion fan module (SF-DRPC-W-R10) to the DRPC-242-ADL-P Series, and secure it using the 4 screws removed previously.
- Step 3:** Connect the fan cable to the fan connector on the side panel.

DRPC-242-ADL-P

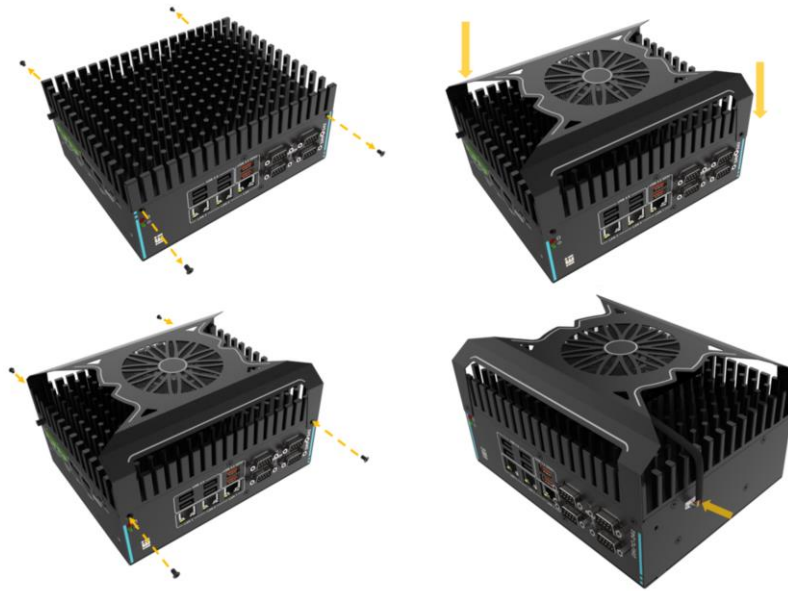

Figure 3-17: External Fan Module Installation

3.11 Mounting Brackets Installation

DRPC-242-ADL-P Series comes with standard rail mounting bracket and supports optional wall mounting bracket. Follow these steps to install

3.11.1 DIN-Rail Installation

Step 1: Turn the embedded system over.

Step 2: Align the retention screw holes in each bracket with the corresponding retention screw holes on the rear surface.



Figure 3-18: Align the retention screw holes

Step 3: Secure the brackets to the system by inserting retention screws (**Figure 3-19**)

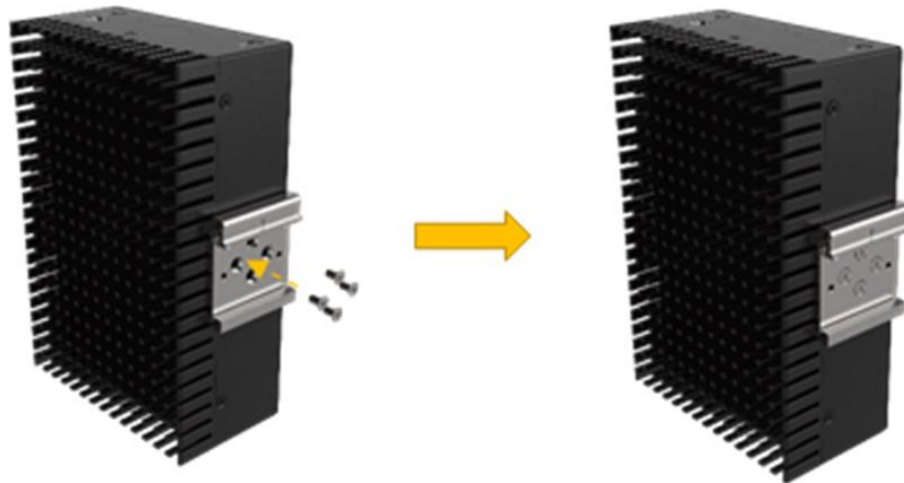

Figure 3-19: DIN Rail Mounting Bracket Installation

Step 4: Attach the upper edge of the mounting bracket at an angle. Push the system towards the DIN rail until mounting bracket hangs securely.

DRPC-242-ADL-P

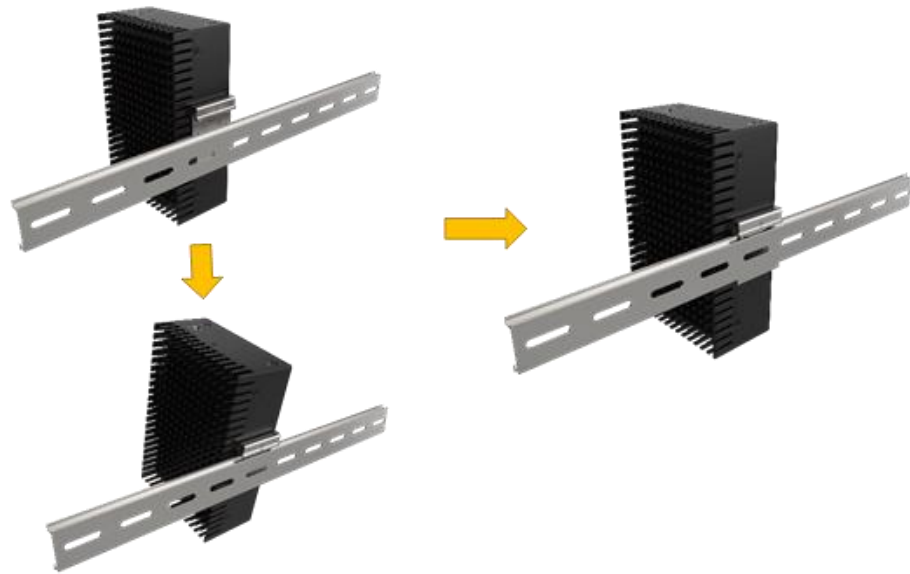

Figure 3-20: Mounting the system

3.11.2 Wall Mounting Installation

DRPC-242-ADL-P Series can be mounted by using the optional wall mount bracket, follow the steps below to install.

Step 1: Turn the embedded system over.

Step 2: Align the retention screw holes in each bracket with the corresponding retention screw holes on the bottom surface.



Figure 3-21: Align the retention screw holes

Step 3: Secure the brackets to the system by inserting retention screws into each bracket
(Figure 3-22&Figure 3-23)

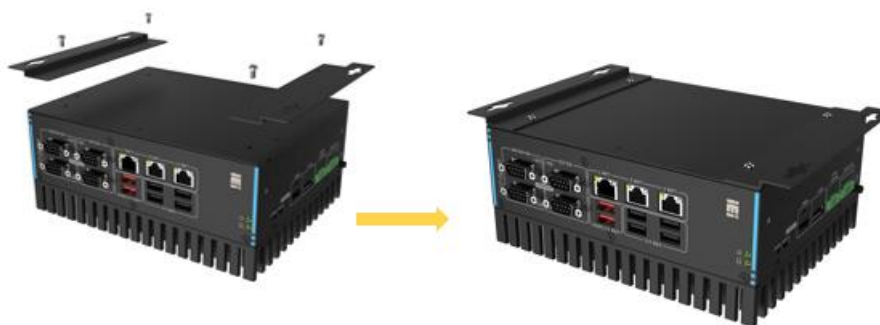

Figure 3-22: Mounting Bracket Retention Screw



Figure 3-23: Mounting the system

DRPC-242-ADL-P

3.12 External Peripheral Interface Connectors

The DRPC-242-ADL-P Series has the following connectors. Detailed descriptions of the connectors can be found in the subsections below.

- Ethernet
- Power button
- Power DC jack
- HDMI
- DP
- USB

3.12.1 HDMI/ DP Connector

To connect the HDMI/DP devices, please plug in HDMI/DP connector in the right direction as shown below:



Figure 3-24: HDMI/DP Connection

3.12.2 LAN Connectors

The LAN connectors allow connection to an external network

Step 1: Locate the RJ-45 connectors. The locations of the RJ-45 connectors are shown in **Chapter 1**

Step 2: Align the connectors. Align the RJ-45 connector on the LAN cable with one of the RJ-45 connectors on the **DRPC-242-ADL-P** Series. See

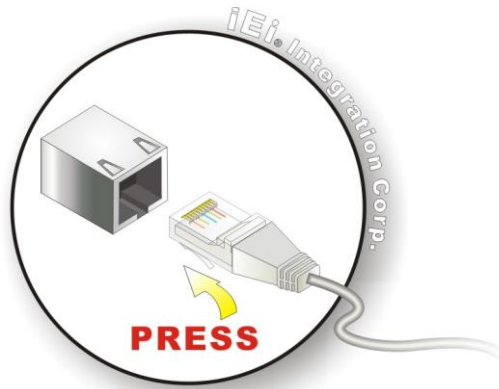

Figure 3-25: LAN Connection

Step 3: Insert the LAN cable RJ-45 connector. Once aligned, gently insert the LAN cable RJ-45 connector into the on-board RJ-45 connector

The RJ-45 Ethernet connector has two status LEDs, one green and one yellow. The green LED indicates activity on the port and the yellow LED indicates the port is linked.



Figure 3-26: RJ-45 Ethernet Connector

Activity/Link LED		Speed LED	
STATUS	DESCRIPTION	STATUS	DESCRIPTION
Off	No link	Off	10 Mbps connection
Yellow	Linked	Green	1000 Mbps connection
Blinking	TX/RX activity	Orange	2.5 Gbps connection

Table 3-1: RJ-45 Ethernet Connector LEDs

3.13 Power Connector

**WARNING:**

To Make sure a power supply with the correct input voltage is being fed into the system. Incorrect voltages applied to the system may cause damage to the internal electronic components and may also cause injury to the user.

The power of the system needs more than 12V5A

Step 1: Connect the power source to the power input jack.

Step 2: Push the power button, and the power LED on the front panel turns on.

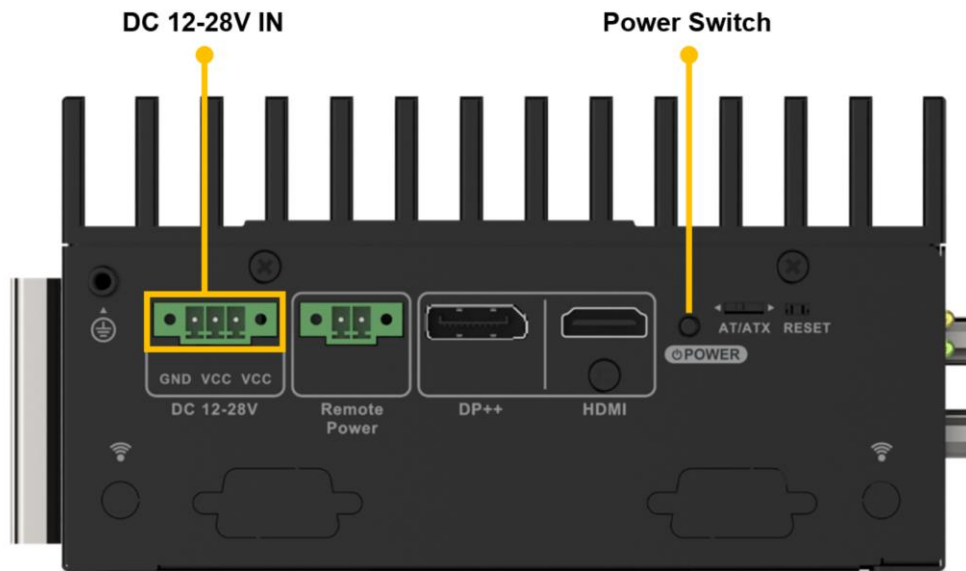

Figure 3-27: Power Connector

- **Power on** the system: press the power button for 1 seconds
- **Power off** the system: press the power button for 6 seconds

Power & HDD LED

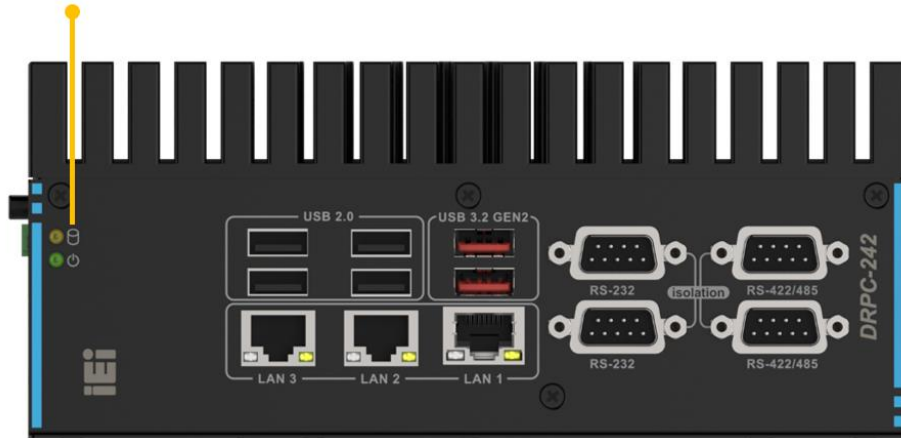
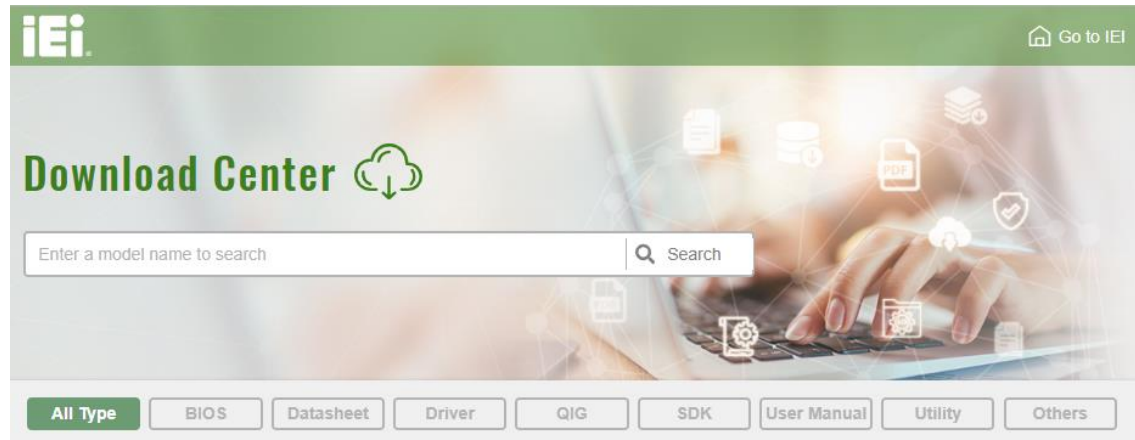

Figure 3-28:Power & HDD LED

DRPC-242-ADL-P

3.14 Available Drivers

All the drivers for the DRPC-242-ADL-P Series are available on IEI Resource Download Center (<https://download.ieiworld.com>). Type DRPC-242-ADL-P Series and press Enter to find all the relevant software, utilities, and documentation.



IEI Resource Download Center

3.14.1 Driver Download

To download drivers from IEI Resource Download Center, follow the steps below.

Step 1: Go to <https://download.ieiworld.com>. Type DRPC-242-ADL-P Series and press Enter.

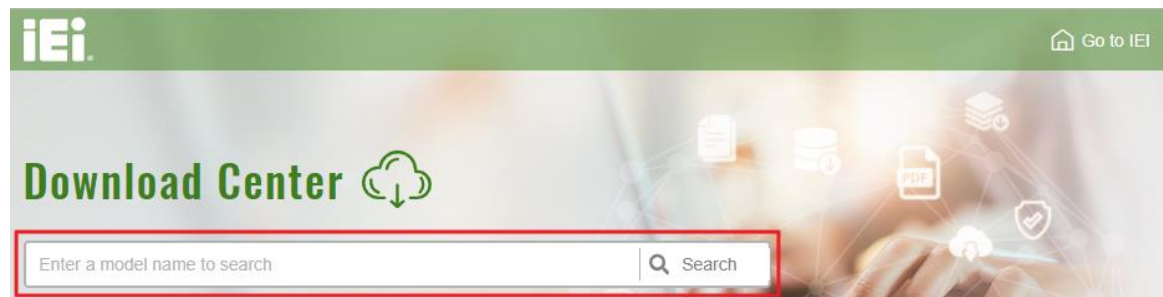

Step 2: All product-related software, utilities, and documentation will be listed. You can choose **Driver** to filter the result.

[All Type](#)
[BIOS](#)
[Datasheet](#)
[Driver](#)
[QIG](#)
[SDK](#)
[User Manual](#)
[Utility](#)
[Others](#)

WAFER-BT-i1 [Product Info](#)

[Embedded Computer](#) ▶ [Single Board Computer](#) ▶ [Embedded Board](#)
 3.5" SBC with Intel® 22nm Atom™/Celeron® on-board SoC

Driver

File Name	Published	Version	File Checksum
7B000-001033-RS V2.3.iso (2.23 GB)	2017/10/03	2.30	3B2DB1F792779A93A8F50DDBC3943E30

Step 3: Click the driver file name on the page and you will be prompted with the following window. You can download the entire ISO file (❶), or click the small arrow to find an individual driver and click the file name to download (❷).

7B000-001168-RS_V1.4.iso

❶ [Click here to download entire ISO file. \(2.99 GB\)](#)

* Download individual file *

- Docs
 - 1.Chipset
 - 10.1.1.12.zip (2.7 MB)
 - 2.VGA
 - 3.Audio
 - 4.Lan
 - 5.USB 3.0
 - 6.Serial IO
 - 7.TXE
 - 8.Manual

❷

NOTE:

To install software from the downloaded ISO image file in Windows 10 (or later), double-click the ISO file to mount it as a virtual drive to view its content.

DRPC-242-ADL-P

3.15 Maintenance

To configure the jumper settings, please follow the steps below.

Step 1: Remove the top cover. See **Figure 3-1**.

Step 2: Locate the jumper on the embedded motherboard.

Step 3: Make the jumper settings in accordance with the settings described and defined in the following sections.

3.15.1 Flash Descriptor Security Override Jumper

CN Label:	ME_FLASH1
CN Type:	2-pin header, P=1.27mm
CN Location:	See Figure 3-29
CN Pinouts:	See Table 3-2

The ME_FLASH1 connector is used for Flash Descriptor Security Override or ME Debug Mode

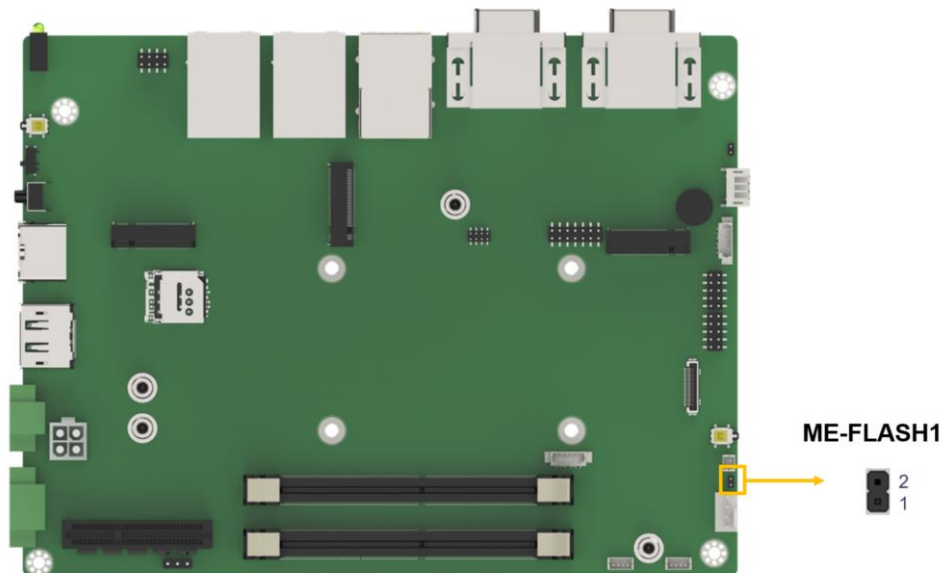

Figure 3-29: ME Override Setting Jumper Locations

Setting	Description
Open	Disabled (Default)
Short	Enabled

Table 3-2: ME Override Setting Jumper Pinouts

To update the ME firmware, please follow the steps below

- Step 1:** Before turning on the system power, short the Flash Descriptor Security Override jumper.
- Step 2:** Update the BIOS and ME firmware, and then turn off the system power.
- Step 3:** Remove the metal clip on the Flash Descriptor Security Override jumper to its default setting
- Step 4:** Restart the system. The system will reboot 2 ~ 3 times to complete the ME firmware update

3.15.2 Clear CMOS Button

- CN Label:** J_CMOS1
- CN Type:** Button
- CN Location:** See **Figure 3-30**
- CN Pinouts:** See **Table 3-3**

To clear the CMOS Setup (for example if you have forgotten the password, you should clear the CMOS and then reset the password), you should disconnect the RTC battery and press the button for about 3 seconds. This will set back to normal operation mode.

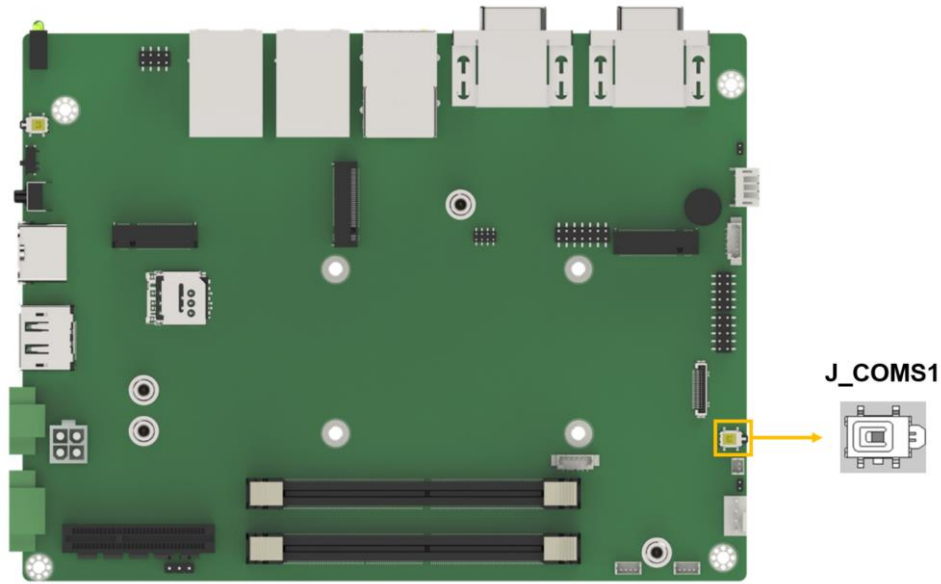

Figure 3-30: Clear CMOS Location

PIN NO.	DESCRIPTION
NC (default)	Keep CMOS Setup (Normal Operation)
Press button	Clear CMOS Setup

Table 3-3: Clear CMOS Pinouts

3.15.3 AT/ATX Power Mode Setting

- CN Label:** J_ATX_AT1
- CN Type:** 3-pin switch
- CN Location** See **Figure 3-31**

The AT/ATX power mode selection is made through the AT/ATX power mode switch which is shown in.

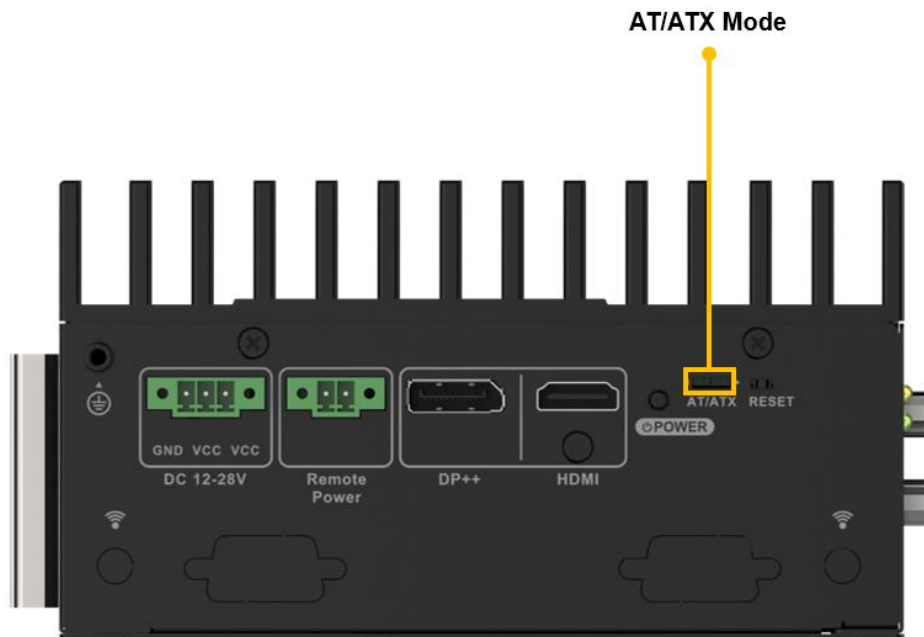

Figure 3-31: AT/ATX Power Mode Setting Location

Chapter

4

System Motherboard

4.1 Overview

The connectors and jumpers of the system motherboard are listed in the following sections.

4.1.1 Layout

The following diagram shows the locations of the internal/external connectors and jumpers on the motherboard.

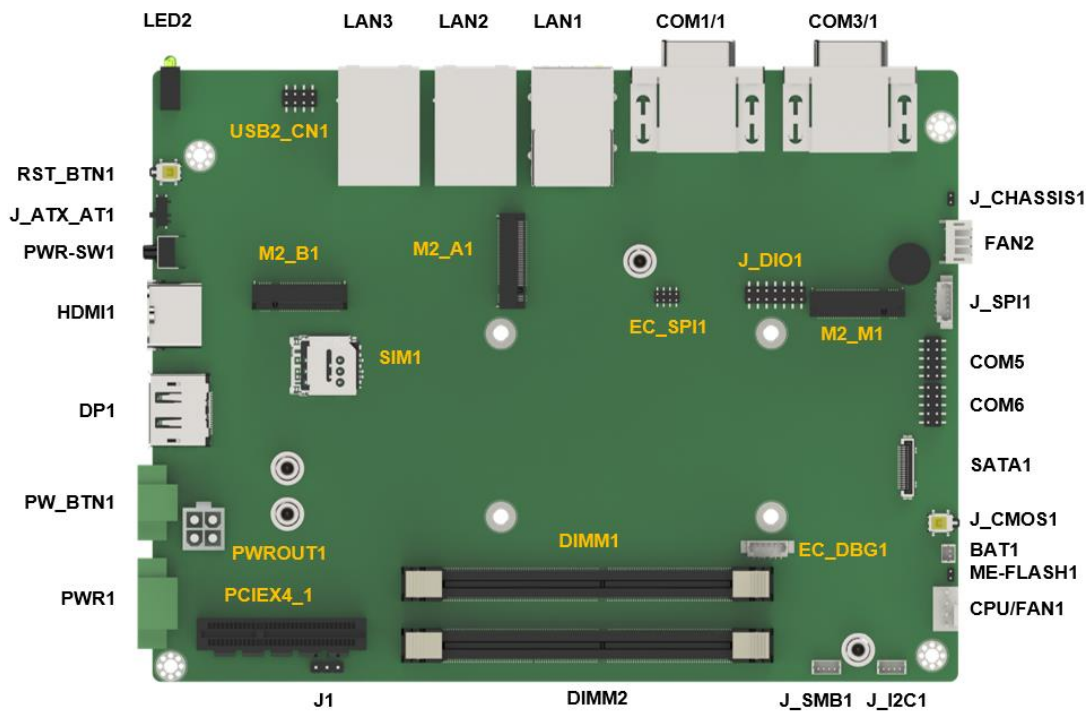

Figure 4-1: Connector and Jumper Locations

DRPC-242-ADL-P

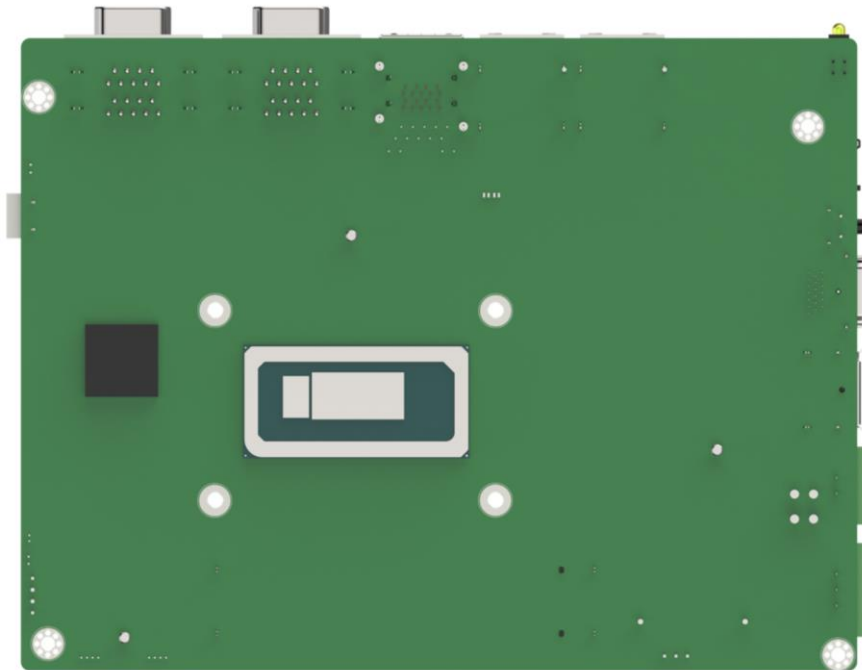

Figure 4-2: System Motherboard (Rear)

4.2 Peripheral Interface Connectors

The table below lists all the connectors on the board.

Connector	Type	Label
USB 2.0 connector	8-pin header	USB2_CN1
M.2 3042/52/80 B-key slot	M.2 B-key slot	M2_B1
SIM card slot	SIM slot	SIM1
Edge card socket	64-pin socket	PCIEX4_1
Power Management ROM connector	3-pin header	J1
DDR4 SO-DIMM socket	260-pin DDR4 SO-DIMM	DIMM1, DIMM2
M.2 2230 A-key slot	M.2 A-key slot	M2_A1
Flash EC ROM connector	8-pin header	EC_SPI1
Digital I/O connector	14-pin header	J_DIO1

M.2 2280 M-key slot	M.2 M-key slot	M2_M1
Chassis intrusion connector	2-pin header	J_CHASSIS1
Flash SPI ROM connector	6-pin wafer	J_SPI1
RS-232 serial port connector	10-pin header	COM5 COM6
SATA 6Gb/s drive connectors	iSATA connector	SATA1
Clear CMOS button	button	J_CMOS1
Battery connector	2-pin wafer	BAT1
Flash descriptor override setting jumper	2-pin header	ME_FLASH1
Fan connector	4-pin wafer	CPU/FAN1
I ² C connector	4-pin wafer	I2C1
SMBus connector	4-pin wafer	J_SMB1
EC debug connector	6-pin wafer	EC_DBG1
12V Power Output connector	4-pin molex	PWROUT1

Table 4-1: Internal Peripheral Connectors

4.2.1 RTC Battery Connector



CAUTION:

Risk of explosion if battery is replaced by an incorrect type. Only certified engineers should replace the on-board battery.

Dispose of used batteries according to instructions and local regulations.

DRPC-242-ADL-P



NOTE:

It is recommended to attach the RTC battery onto the system chassis in which the DRPC-242-ADL-P Series is installed.

- CN Label:** **BAT1**
- CN Type:** 2-pin wafer, p=1.25 mm
- CN Location:** See **Figure 4-3**
- CN Pinouts:** See **Table 4-2**

The battery connector is connected to the system battery. The battery provides power to the system clock to retain the time when power is turned off. Clear CMOS Button Connector

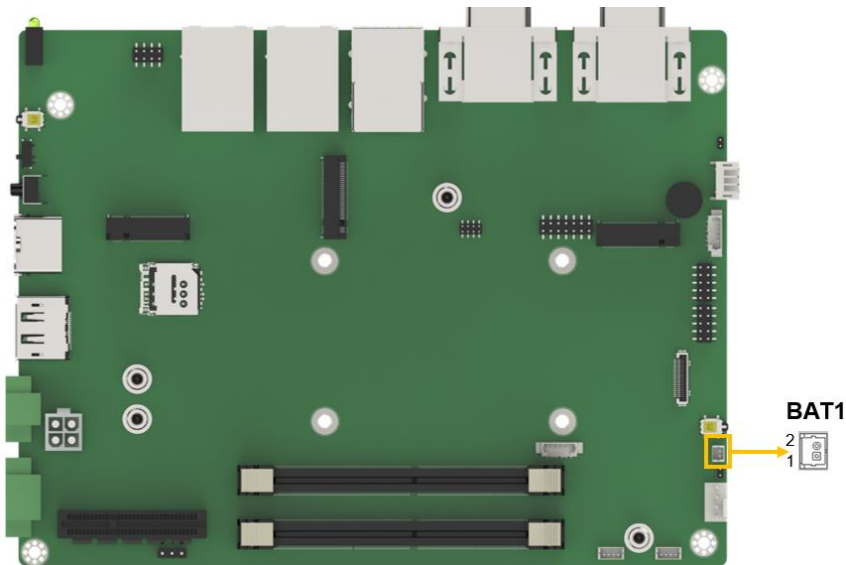

Figure 4-3: Battery Connector Location

Pin	Description
1	VBAT+
2	GND

Table 4-2: Battery Connector Pinouts

To clear the CMOS Setup (for example if you have forgotten the password, you should clear the CMOS and then reset the password), you should disconnect the RTC battery and press the button for about 3 seconds. This will set back to normal operation mode.

4.2.2 SIM card Connector

- CN Label:** SIM1
- CN Type:** 7-pin SIM holder
- CN Location:** See **Figure 4-4**
- CN Pinouts:** See **Table 4-3**

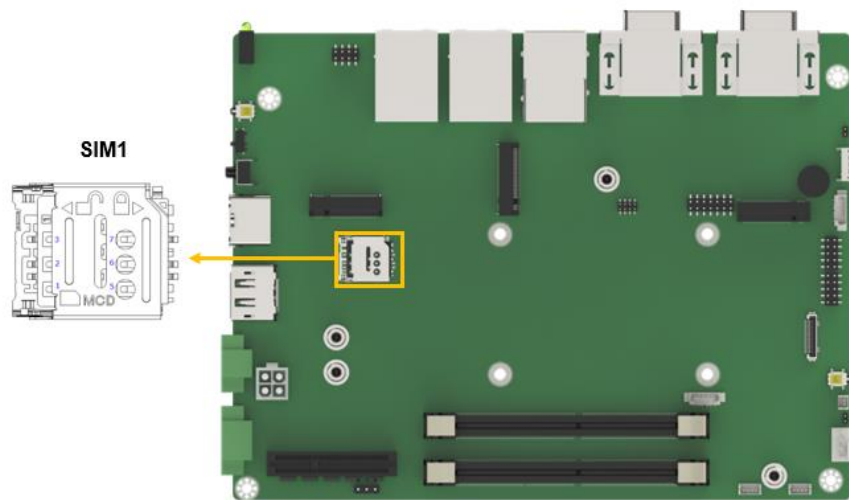

Figure 4-4: SIM card Connector Locations

Pin	Description	Pin	Description
1	SIM_VCC	5	GND
2	SIM_RST	6	N/C
3	SIM_Clock	7	SIM_DATA

Table 4-3: SIM Card Connector Pinouts

DRPC-242-ADL-P



CAUTION:

A WWAN module must be installed in the M.2 B-key slot to provide WWAN communication.

4.2.3 Internal USB 2.0 Connectors

- CN Label:** USB2_CN1
- CN Type:** 8-pin header, p=2.00 mm
- CN Location:** See **Figure 4-5**
- CN Pinouts:** See **Table 4-4**

Each USB connector provides two USB 2.0 ports by dual-port USB cable.

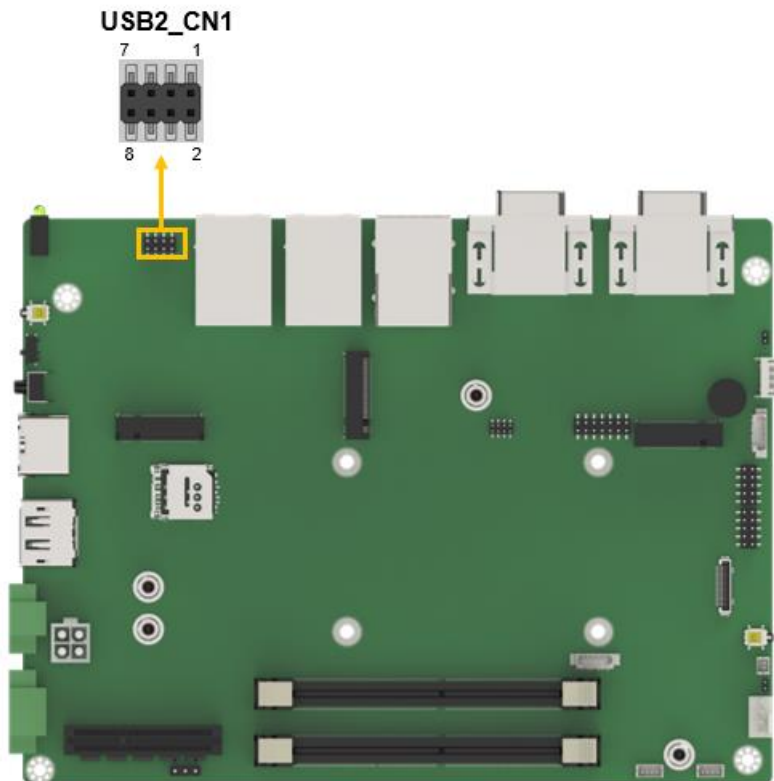

Figure 4-5: Internal USB 2.0 Connectors Locations

PIN NO.	DESCRIPTION	PIN NO.	DESCRIPTION
1	VCC	2	GND
3	USB DATA-	4	USB DATA+
5	USB DATA+	6	USB DATA-
7	GND	8	VCC

Table 4-4: Internal USB 2.0 Connectors Pinouts

4.2.4 Fan Connector

- CN Label:** CPU/FAN1
- CN Type:** 4-pin wafer, p=2.54 mm
- CN Location:** See Figure 4-6
- CN Pinouts:** See Table 4-5

The fan connector attaches to a extend system cooling fan.

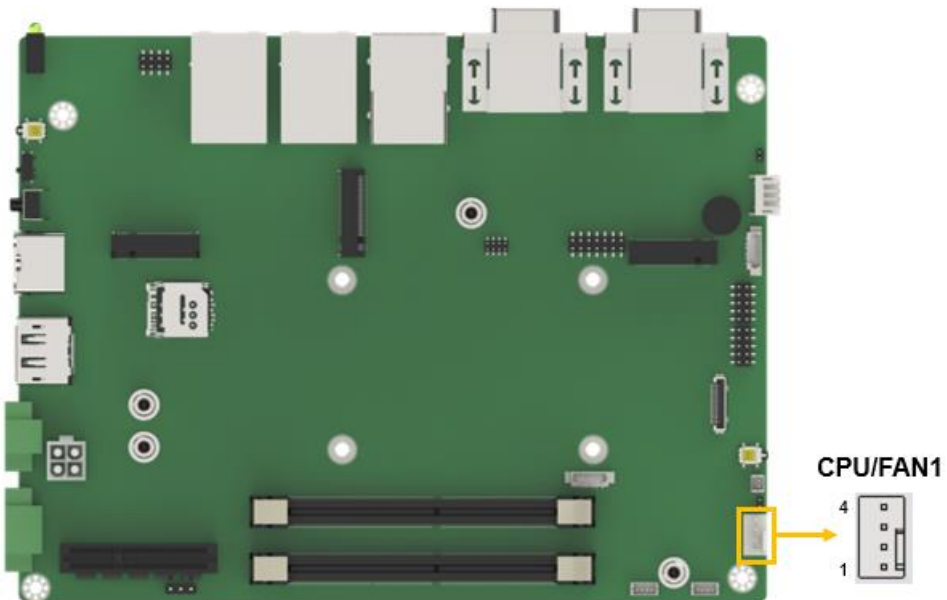

Figure 4-6: Fan Connector Location

Pin	Description
1	GND
2	+12V

DRPC-242-ADL-P

Pin	Description
3	FANIO
4	PWM

Table 4-5: Fan Connector Pinouts

4.2.5 Digital Input / Output Connector

- CN Label:** J_DIO1
- CN Type:** 14-pin header, p=2.00 mm
- CN Location:** See Figure 4-7
- CN Pinouts:** See Table 4-6

The Digital I/O connector provides programmable input and output for external device.

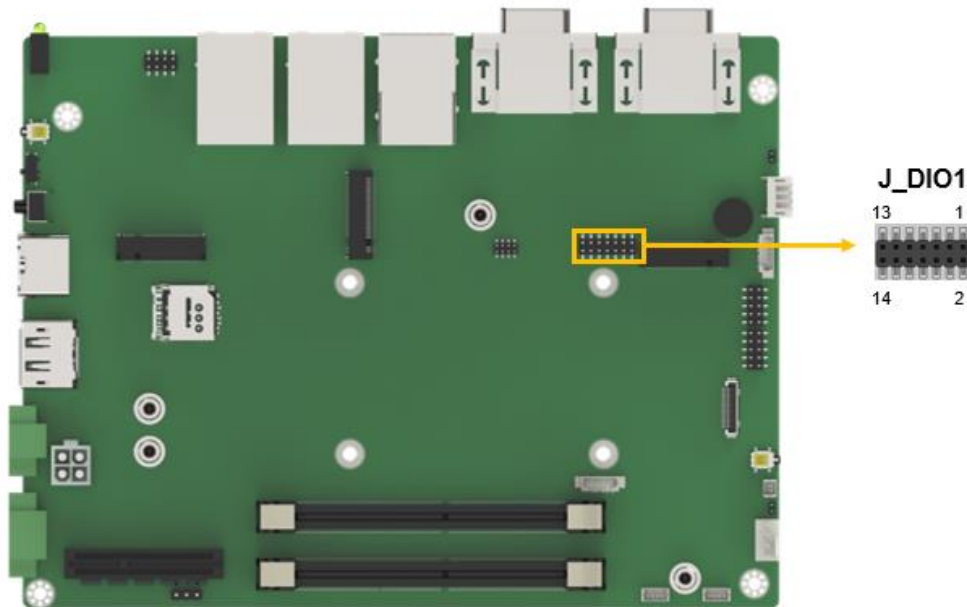

Figure 4-7: Digital I/O Connector Location

Pin	Description	Pin	Description
1	GND	2	VCC
3	Output 5	4	Output 4

Pin	Description	Pin	Description
5	Output 3	6	Output 2
7	Output 1	8	Output 0
9	Input 5	10	Input 4
11	Input 3	12	Input 2
13	Input 1	14	Input 0

Table 4-6: Digital I/O Connector Pinouts

4.2.6 M.2 M-key Slot

- CN Label:** M2_M1
- CN Type:** M.2 M-key slot
- CN Location:** See **Figure 4-8**
- CN Pinouts:** See **Table 4-7**

The M.2 M key (2280) slot with PCIe Gen3 x2 supports NVMe storage.

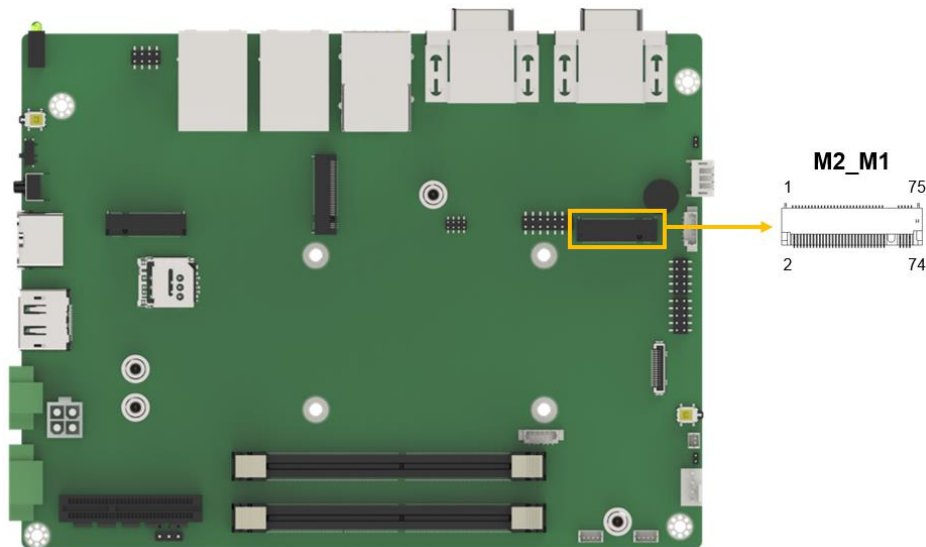

Figure 4-8: M.2 M-key Slot Location

PIN NO.	DESCRIPTION	PIN NO.	DESCRIPTION
1	GND	2	+V3P3S_SSD
3	GND	4	+V3P3S_SSD
5	NC	6	NC

DRPC-242-ADL-P

7	NC	8	NC
9	GND	10	M2M_LED_N
11	NC	12	+V3P3S_SSD
13	NC	14	+V3P3S_SSD
15	GND	16	+V3P3S_SSD
17	NC	18	+V3P3S_SSD
19	NC	20	NC
21	GND	22	NC
23	NC	24	NC
25	NC	26	NC
27	GND	28	NC
29	PCIE_RXN5	30	NC
31	PCIE_RXP5	32	NC
33	GND	34	NC
35	PCIE_TXN5_C	36	NC
37	PCIE_TXP5_C	38	M_1_SSD_SLP
39	GND	40	M.2_SMCLK
41	PCIE_RXN4	42	M.2_SMDAT
43	PCIE_RXP4	44	NC
45	GND	46	NC
47	PCIE_TXN4	48	NC
49	PCIE_TXP4	50	PLT_RST_N
51	GND	52	PLT_RST_N
53	CLK_M2_M_N	54	TP320
55	CLK_M2_M_P	56	N/C
57	GND	58	N/C
59	Module Key	60	Module Key
61	Module Key	62	Module Key
63	Module Key	64	Module Key
65	Module Key	66	Module Key
67	NC	68	TP321
69	NC	70	+V3P3S_SSD
71	GND	72	+V3P3S_SSD
73	GND	74	+V3P3S_SSD

75	GND	
----	-----	--

Table 4-7: M.2 M-key Slot Pinouts

4.2.7 M.2 B-key Slot

- CN Label:** M2_B1
- CN Type:** M.2 B-key slot
- CN Location:** See **Figure 4-9**
- CN Pinouts:** See **Table 4-8**

The M.2 B key (2242) slot with SATA signal.

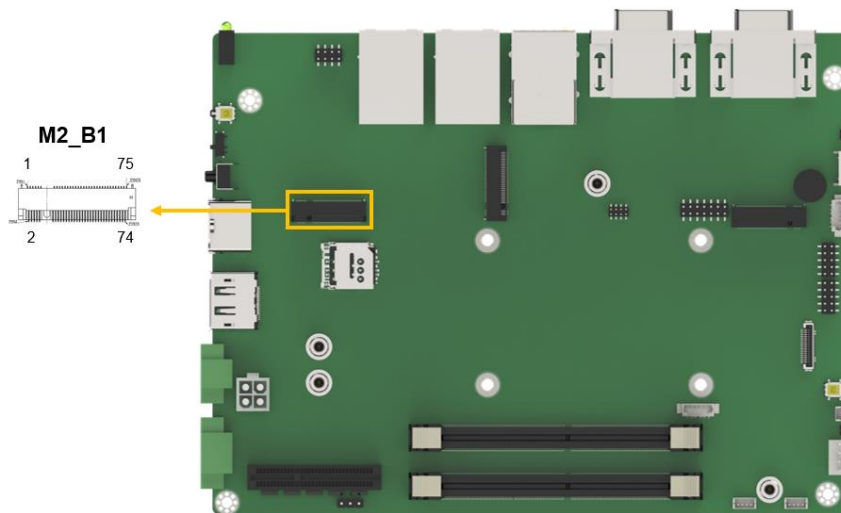

Figure 4-9: M.2 B-key Slot Location

Pin	Description	Pin	Description
1	GND	2	+V3.3_B2
3	GND	4	+V3.3_B2
5	GND	6	NC
7	NC	8	NC
9	NC	10	+V3.3_B2
11	GND	12	NC
13	Module Key	14	Module Key

DRPC-242-ADL-P

Pin	Description	Pin	Description
15	Module Key	16	Module Key
17	Module Key	18	Module Key
19	Module Key	20	Module Key
21	GND	22	NC
23	NC	24	NC
25	NC	26	NC
27	GND	28	NC
29	NC	30	NC
31	NC	32	NC
33	GND	34	NC
35	NC	36	NC
37	NC	38	NC
39	GND	40	M.2_SMCLK
41	SATA_RX0+	42	M.2_SMDAT
43	SATA_RX0-	44	NC
45	GND	46	NC
47	SATA_RX0+	48	NC
49	SATA_RX0-	50	PLT_RST_N
51	GND	52	NC
53	NC	54	NC
55	NC	56	NC
57	GND	58	NC
59	NC	60	NC
61	NC	62	NC
63	NC	64	NC
65	NC	66	NC
67	NC	68	NC
69	GND	70	+V3.3_B2
71	GND	72	+V3.3_B2
73	GND	74	+V3.3_B2
75	GND		

Table 4-8: M.2 B-Key Slot Pinouts

4.2.8 M.2 A-key Slot

- CN Label:** M2_A1
- CN Type:** M.2 A-key slot
- CN Location:** See **Figure 4-10**
- CN Pinouts:** See **Table 4-9**

The M.2 slot is keyed in the A position and accepts 2230 size of M.2 modules. The M.2 slot supports PCIe x1 and USB 2.0 signals.

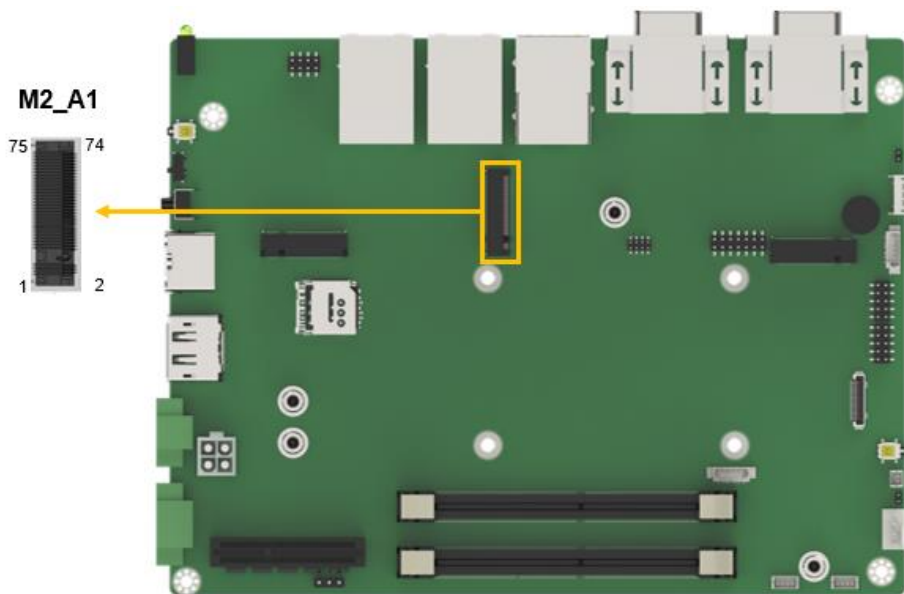

Figure 4-10: M.2 A-key Slot Location

Pin	Description	Pin	Description
1	GND	2	+3.3V
3	USB2_DP	4	+3.3V
5	USB2_DN	6	NC
7	GND	8	Module Key
9	Module Key	10	Module Key
11	Module Key	12	Module Key
13	Module Key	14	Module Key
15	Module Key	16	NC
17	NC	18	GND

DRPC-242-ADL-P

Pin	Description	Pin	Description
19	NC	20	NC
21	NC	22	NC
23	GND	24	GND
25	NC	26	NC
27	NC	28	NC
29	GND	30	GND
31	NC	32	NC
33	GND	34	NC
35	PCIE_TX_DP	36	GND
37	PCIE_TX_DN	38	WLAN_CL_RST_N
39	GND	40	WLAN_CL_DATA
41	PCIE_RX_DP	42	WLAN_CL_CLK
43	PCIE_RX_DN	44	NC
45	GND	46	NC
47	PCIE_CLK+	48	NC
49	PCIE_CLK-	50	NC
51	GND	52	PLT_RST
53	NC	54	BT_ON
55	PCH_WAKE_N	56	WLAN_OFF
57	GND	58	NC
59	NC	60	NC
61	NC	62	NC
63	GND	64	NC
65	NC	66	NC
67	NC	68	NC
69	GND	70	NC
71	NC	72	+3.3V
73	NC	74	+3.3V
75	GND		

Table 4-9: M.2 A-Key Slot Pinouts

4.2.9 DDR4 SO-DIMM Socket

- CN Label:** DIMM1, DIMM2
- CN Type:** 260-pin DDR4 SO-DIMM slot
- CN Location:** See Figure 4-11

The SO-DIMM slots are for installing the DDR4 SO-DIMM.

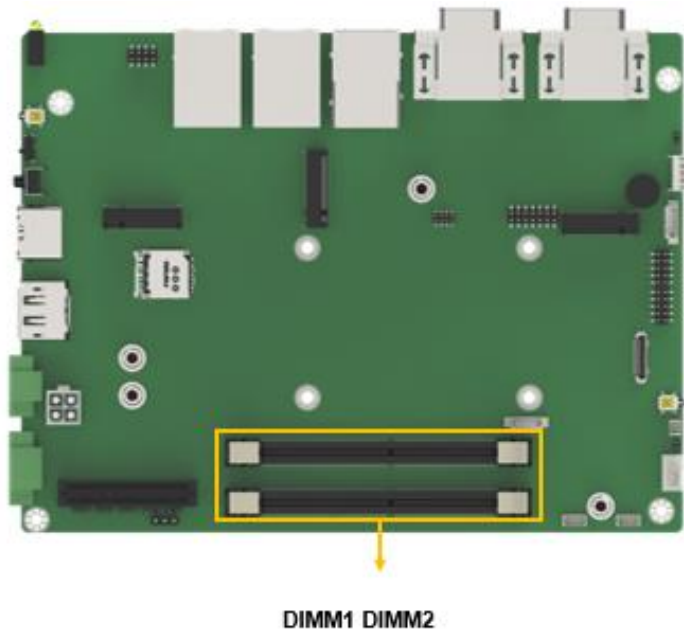

Figure 4-11: DDR4 SO-DIMM Socket Location



CAUTION:

For dual channel configuration, always install two identical memory modules that feature the same capacity, timings, voltage, number of ranks and the same brand.

DRPC-242-ADL-P

4.2.10 PCIe x4 Slot

CN Label: **PCIEX4_1**

CN Type: PCIe x4 Slot

CN Location: See **Figure 4-12**

The PCIe x4 slot enables a PCIe x4 expansion module to be connected to the board.

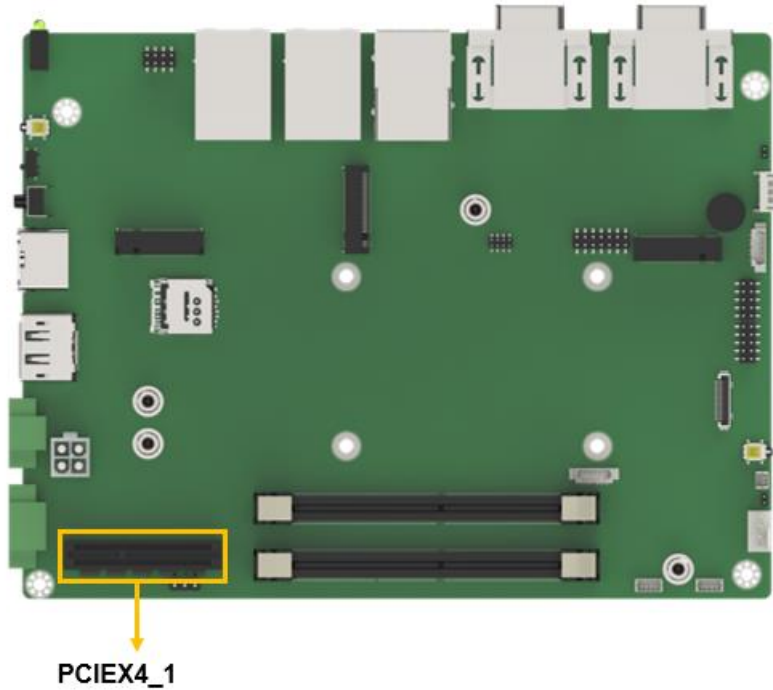

Figure 4-12: PCIe x4 Slot Location

4.2.11 RS-232 Serial Port Connector

- CN Label:** COM5, COM6
- CN Type:** 10-pin header, p=2.00 mm
- CN Location:** See **Figure 4-13**
- CN Pinouts:** See **Table 4-10**

The serial connector provides RS-232 connection.

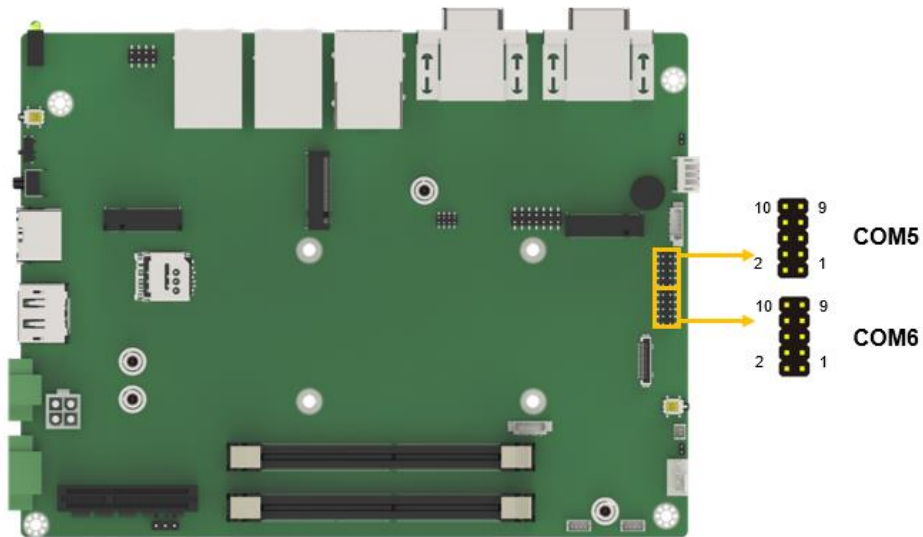

Figure 4-13: RS-232 Serial Port Connector Location

PIN NO.	DESCRIPTION	PIN NO.	DESCRIPTION
1	DCD	2	DSR
3	RXD	4	RTS
5	TXD	6	CTS
7	DTR	8	RI
9	GND		

Table 4-10: RS-232 Serial Port Connector Pinouts

DRPC-242-ADL-P

4.2.12 12V Power Output Connector

- CN Label:** PWROUT1
- CN Type:** 4-pin Molex, p=4.2 mm
- CN Location:** See **Figure 4-14**
- CN Pinouts:** See **Table 4-11**

This 12V power input connector supports the +12V power supply.

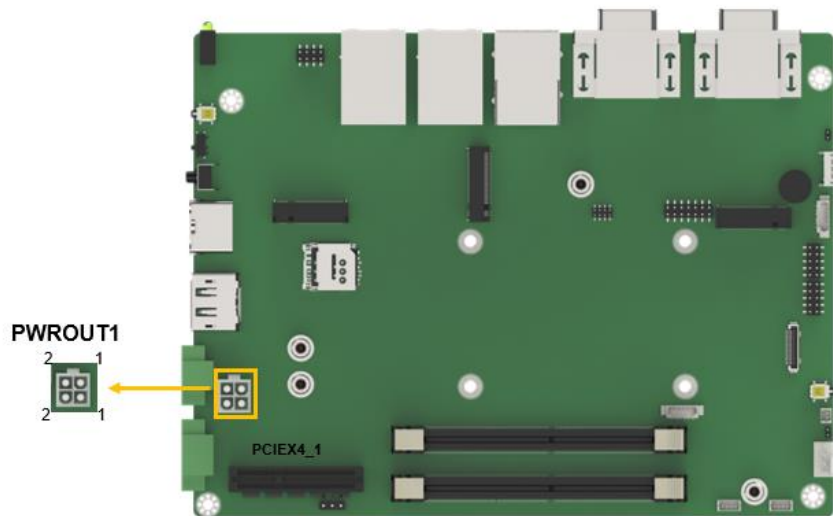

Figure 4-14: 12V Power Output Connector Location

Pin	Description	Pin	Description
1	GND	3	+12V
2	GND	4	+12V

Table 4-11: 12V Power Input Connector Pinouts

4.2.13 SATA 6Gb/s Drive Connector

- CN Label:** SATA1
- CN Type:** 20-pin SATA connector
- CN Location:** See **Figure 4-15**
- CN Pinouts:** See **Table 4-12**

The SATA 6Gb/s drive connector is connected to a SATA 6Gb/s drive. The SATA 6Gb/s drive transfers data at speeds as high as 6Gb/s.

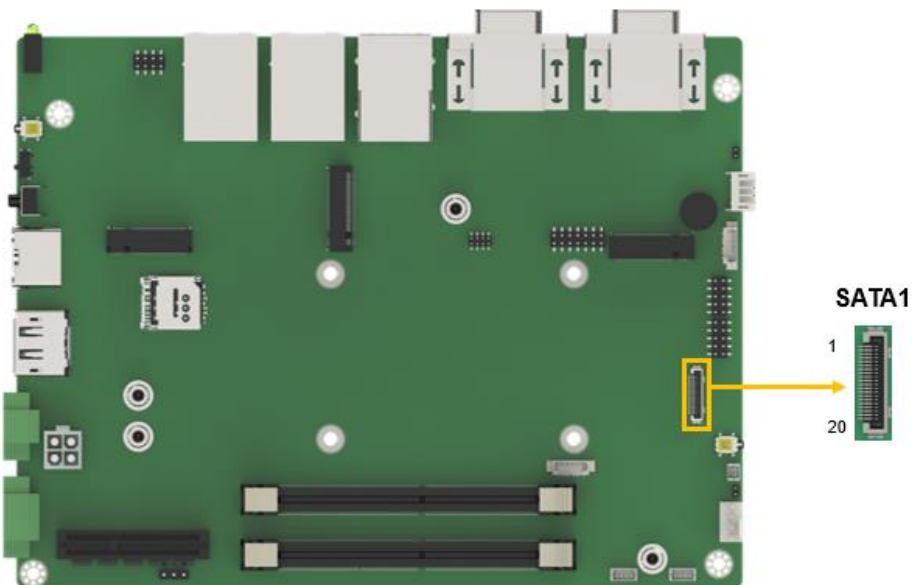

Figure 4-15: SATA 6Gb/s Drive Connectors Location

PIN NO.	DESCRIPTION	PIN NO.	DESCRIPTION
1	GND	11	+V5S
2	GND	12	N/A
3	GND	13	N/A
4	GND	14	GND
5	GND	15	SATA_RX+
6	N/A	16	SATA_RX-
7	+V5S	17	GND
8	+V5S	18	SATA_TX-

DRPC-242-ADL-P

9	+V5S	19	SATA_TX+
10	+V5S	20	GND

Table 4-12: SATA 6Gb/s Drive Connector Pinouts

4.2.14 I²C Connector

- CN Label:** I2C1
- CN Type:** 4-pin wafer, p=1.25 mm
- CN Location:** See **Figure 4-16**
- CN Pinouts:** See **Table 4-13**

The I²C connector is used to connect I²C-bus devices to the mainboard.

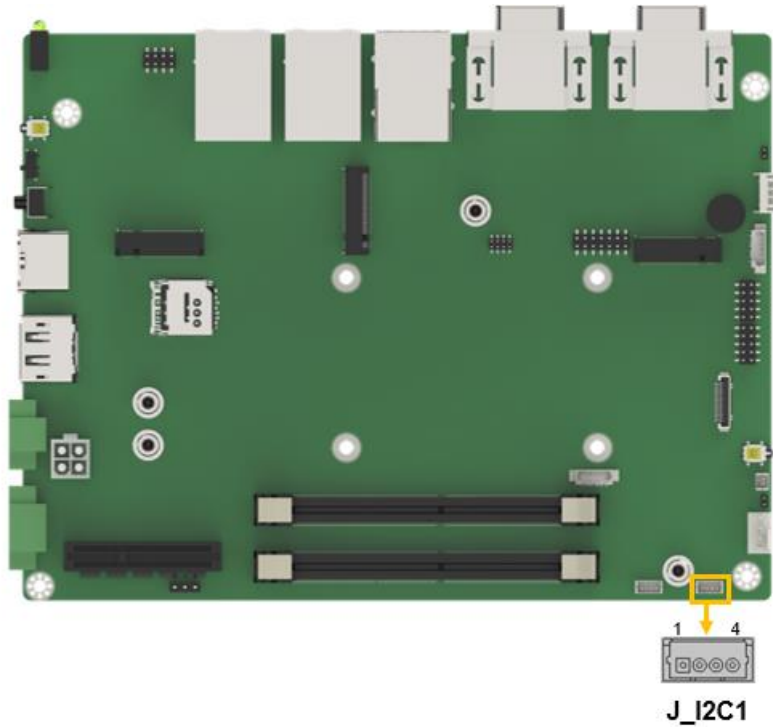

Figure 4-16: I²C Connector Location

Pin	Description
1	GND
2	I2C_DATA
3	I2C_CLK

Pin	Description
4	+5V

Table 4-13: I²C Connector Pinouts

4.2.15 SMBus Connector

- CN Label:** J_SMB1
- CN Type:** 4-pin wafer, p=1.25 mm
- CN Location:** See **Figure 4-17**
- CN Pinouts:** See **Table 4-14**

The SMBus is a two-wire bus used for communication with low bandwidth devices on a motherboard such as power related chips and temperature sensors.

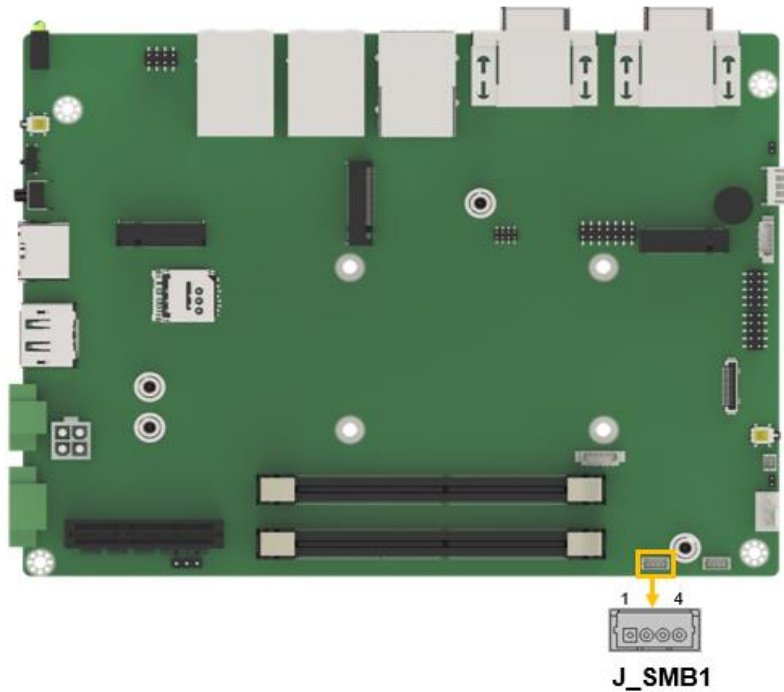

Figure 4-17: SMBus Connector Location

DRPC-242-ADL-P

Pin	Description
1	GND
2	SMB_DATA
3	SMB_CLK
4	+5V

Table 4-14: SMBus Connector Pinouts

4.2.16 Flash SPI ROM Connector

- CN Label:** J_SPI1
- CN Type:** 6-pin wafer, p=1.25 mm
- CN Location:** See Figure 4-18
- CN Pinouts:** See Table 4-15

The 6-pin Flash SPI ROM connector is used to flash the SPI ROM.

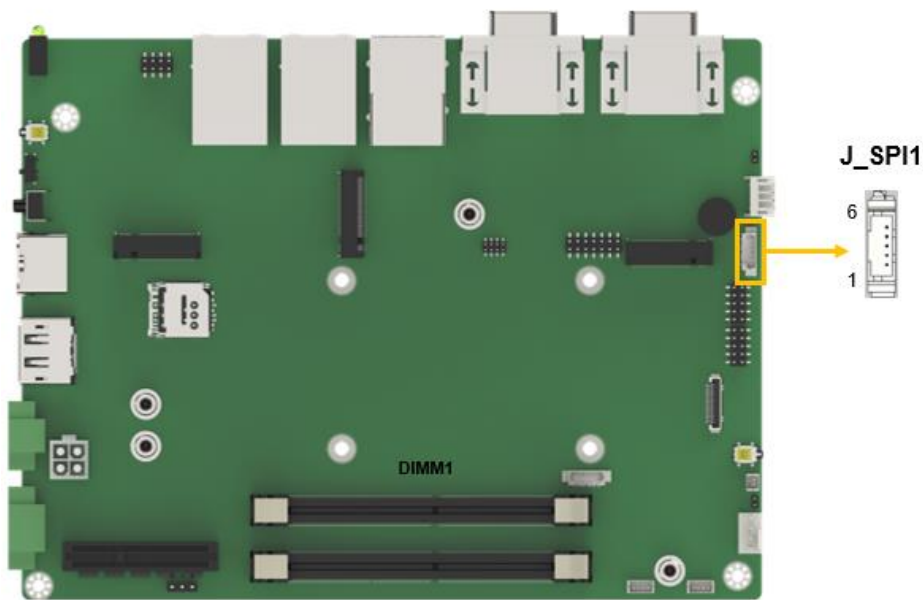

Figure 4-18: Flash SPI ROM Connector Location

Pin	Description
1	+3.3V
2	SPI_CS#

Pin	Description
3	SPI SO
4	SPI CLK
5	SPI SI
6	GND

Table 4-15: Flash SPI ROM Connector Pinouts

4.2.17 Chassis Intrusion Connector

- CN Label:** J_CHASSIS1
- CN Type:** 2-pin header, p=2.54 mm
- CN Location:** See Figure 4-19
- CN Pinouts:** See Table 4-16

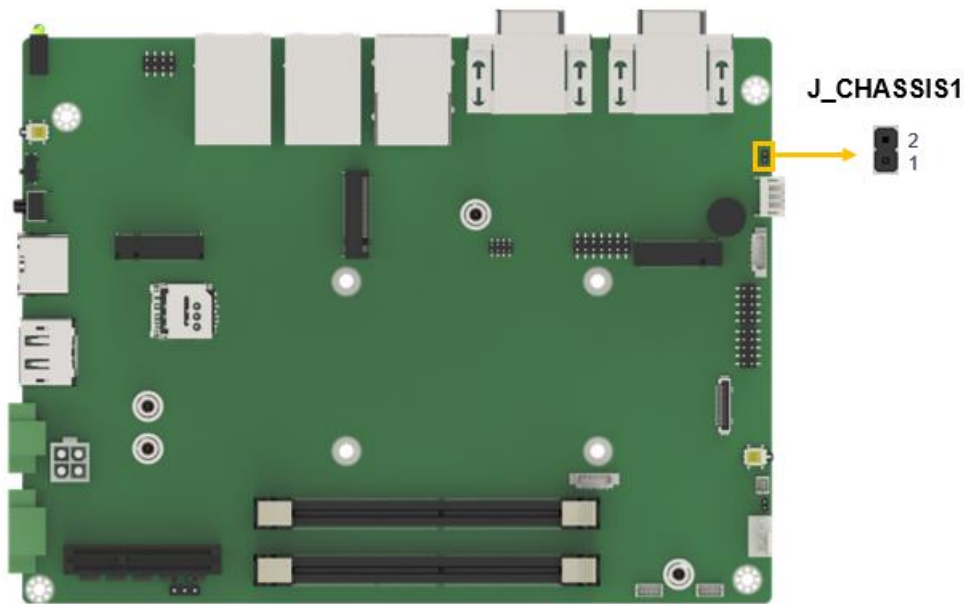

Figure 4-19: Chassis Intrusion Connector Location

Pin	Description
1	CASEOPEN_N
2	GND

Table 4-16: Chassis Intrusion Connector Pinouts

DRPC-242-ADL-P

4.2.18 Flash EC ROM Connector

- CN Label:** EC_SPI1
- CN Type:** 8-pin header, p=1.27 mm
- CN Location:** See Figure 4-20
- CN Pinouts:** See Table 4-17

The 8-pin Flash EC ROM connector is used to flash the EC internal ROM.

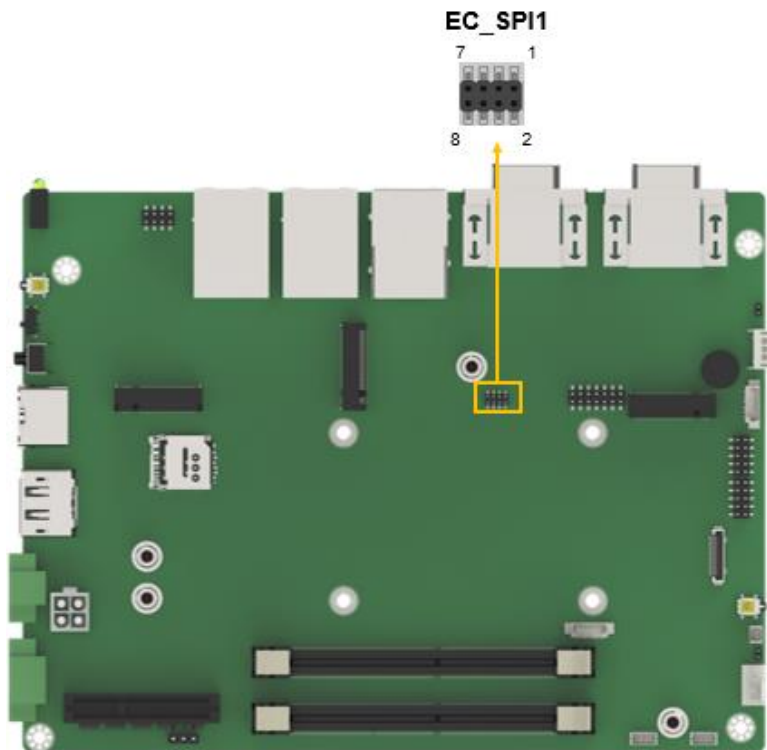

Figure 4-20: Flash EC ROM Connector Location

Pin	Description	Pin	Description
1	SPI_CS#	2	+3.3V
3	SPI_SO	4	NC
5	EC_DET_FLASH	6	SPI_CLK
7	GND	8	SPI_SI

Table 4-17: Flash EC ROM Connector Pinouts

4.2.19 EC Debug Connector

- CN Label:** EC_DBG1
- CN Type:** 6-pin header
- CN Location:** See **Figure 4-21**
- CN Pinouts:** See **Table 4-18**

The EC debug connector is used for EC debug.

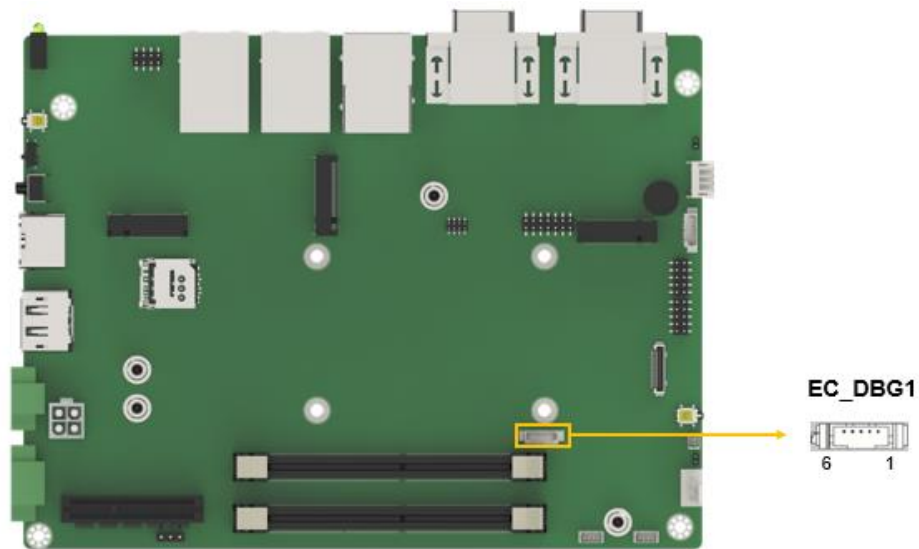

Figure 4-21: EC Debug Connector Location

Pin	Description	Pin	Description
1	NC	4	EDICLK
2	EDICS	5	EDIDI
3	EDIDO	6	GND

Table 4-18: EC Debug Connector Pinouts

DRPC-242-ADL-P

4.2.20 PMBUS Connector

- CN Label:** J1
- CN Type:** 3-pin header, p=2.54mm
- CN Location:** See **Figure 4-22**
- CN Pinouts:** See **Table 4-19**

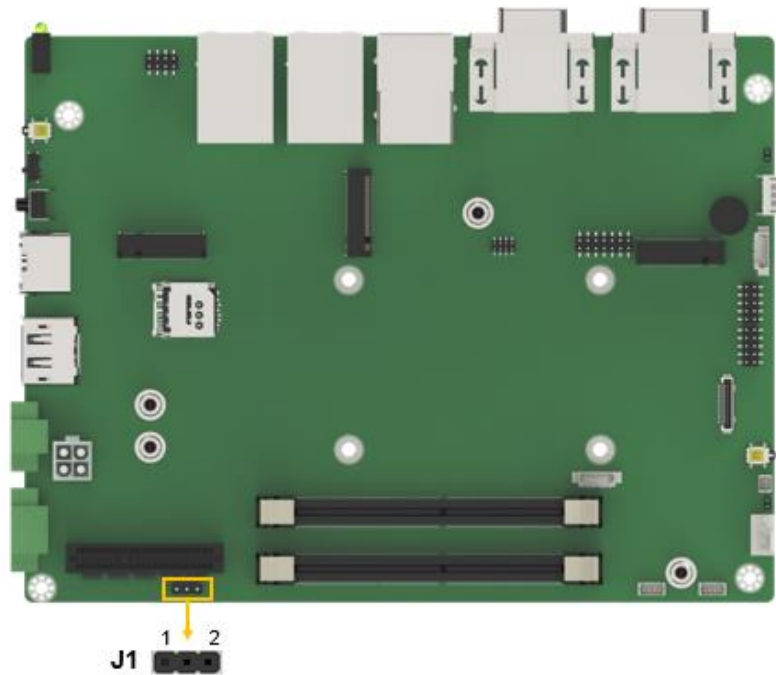

Figure 4-22: PMBUS Connector Location

PIN NO.	DESCRIPTION	PIN NO.	DESCRIPTION
1	PM_SCL	2	PM_SDA
3	GND		

Table 4-19: PMBUS Connector Pinouts

4.3 External Peripheral Interface Connector Panel

The table below lists the connectors on the external I/O panel.

Connector	Type	Label
HDMI connector	HDMI	HDMI1
DP connector	DP	DP1
LAN+USB connectors	RJ45+USB 2.0	LAN2, LAN3
LAN+USB connectors	RJ45+USB 3.2	LAN1
RS-422/485 serial port connector	DB9	COM1/1
RS-232 serial port connector	DB9	COM3/1
Power connector	4-pin Molex	PWR1
Power button connector	3-pin wafer terminal blocks	PWR_BTN1
Power switch	2-pin switch	PWR_SW1
AT/ATX power mode setting	switch	J_ATX_AT1
Reset button connector	2-pin wafer	RST_BTN1
System fan connector	4-pin wafer	FAN2
Power/HDD LED	2-pin wafer	LED2

Table 4-20: Rear Panel Connectors

4.3.1 Power Switch

- CN Label:** PWR_SW1
- CN Type:** 2-pin tact switch
- CN Location:** See **Figure 4-23**

DRPC-242-ADL-P

Pressing this switch will power on the system.

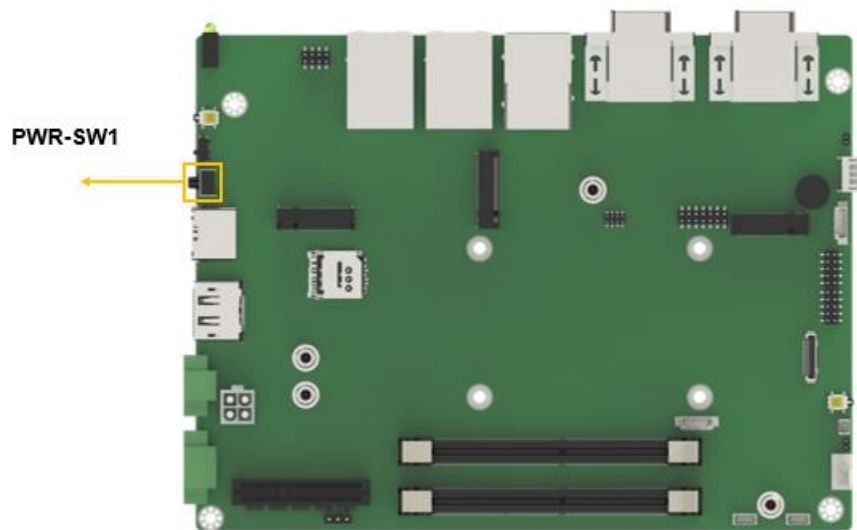

Figure 4-23: Power Switch Location

4.3.2 Reset Button Connector

- CN Label:** RST_BTN1
- CN Type:** 2-pin wafer, p=2.00 mm
- CN Location:** See **Figure 4-24**
- CN Pinouts:** See **Table 4-21**

The reset button connector is connected to a reset switch on the system chassis to enable users to reboot the system when the system is turned on.

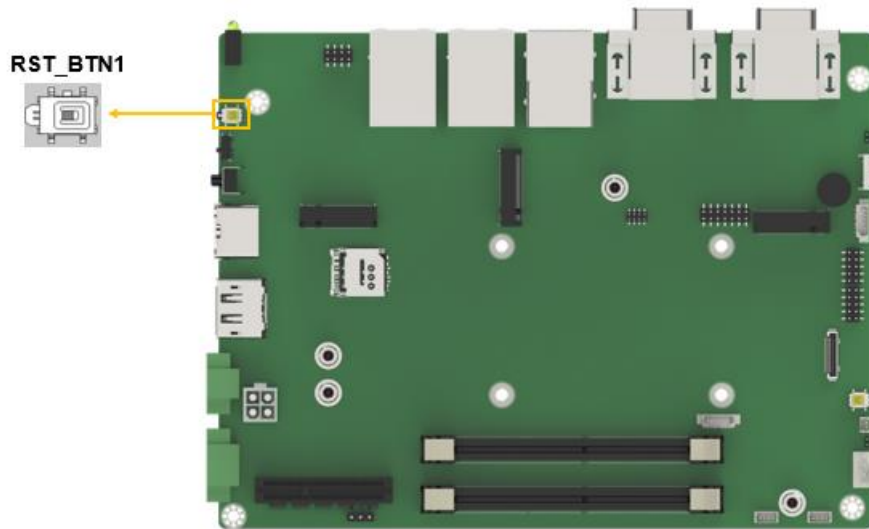

Figure 4-24: Reset Button Connector Location

Pin	Description
1	RESET+
2	RESET-

Table 4-21: Reset Button Connector Pinouts

DRPC-242-ADL-P

4.3.3 HDMI Connectors

- CN Label:** HDMI1
- CN Type:** HDMI connector
- CN Pinouts:** See **Table 4-22** and **Figure 4-25**

The HDMI connectors can connect to HDMI devices.

Pin	Description	Pin	Description
1	HDMI_DATA2	2	GND
3	HDMI_DATA2#	4	HDMI_DATA1
5	GND	6	HDMI_DATA1#
7	HDMI_DATA0	8	GND
9	HDMI_DATA0#	10	HDMI_CLK
11	GND	12	HDMI_CLK#
13	N/C	14	N/C
15	HDMI_SCL	16	HDMI_SDA
17	GND	18	+5V
19	HDMI_HPD		

Table 4-22: HDMI Connector Pinouts

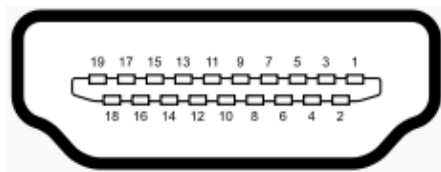

Figure 4-25: HDMI Connector Pinout Locations

4.3.4 System Fan Connector

- CN Label:** FAN2
- CN Type:** 4pin wafer, P=2.00MM
- CN Location:** See **Figure 4-26**
- CN Pinouts:** See **Table 4-23**

The system fan connector can provide 12V/500mA to a system fan.

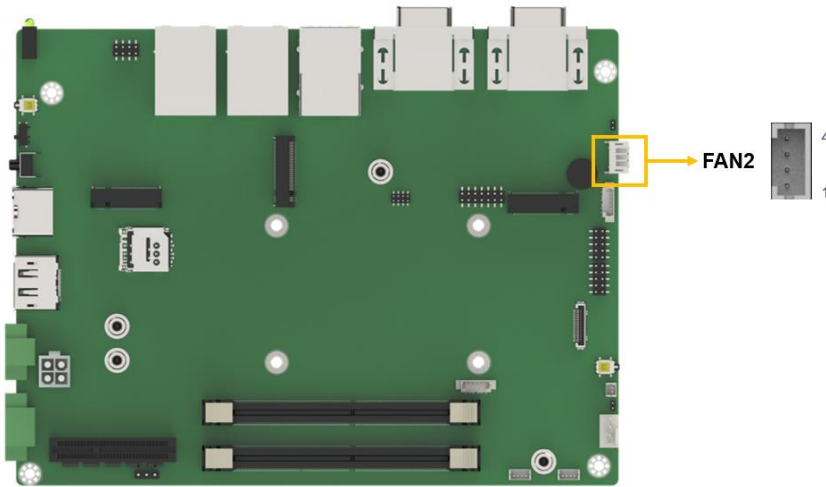

Figure 4-26: System Fan Connector Pinout Locations

PIN NO.	DESCRIPTION
1	GND
2	+V12S
3	Rotation Signal
4	PWM Control Signal

Table 4-23: System Fan Connector Pinouts (FAN2)

DRPC-242-ADL-P

4.3.5 DP Connector

- CN Label:** DP1
- CN Type:** DP connector
- CN Pinouts:** See **Table 4-24** and **Figure 4-27**

The DP connectors can connect to DP devices.

PIN NO.	DESCRIPTION	PIN NO.	DESCRIPTION
1	DATA_0P	11	GND
2	GND	12	DATA_3N
3	DATA_0N	13	CONFIG1
4	DATA_1P	14	CONFIG2
5	GND	15	AUX_P
6	DATA_1N	16	GND
7	DATA_2P	17	AUX_N
8	GND	18	DP HPD
9	DATA_2N	19	GND
10	DATA_3P	20	DP PWR

Table 4-24: DP Connector Pinouts

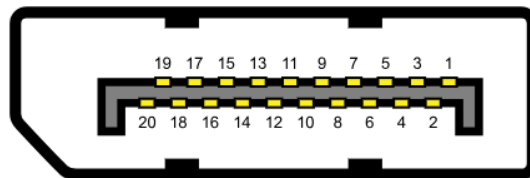

Figure 4-27: DP Connector Pinout Locations

4.3.6 DB-9 RS-232/422/485 Serial Port Connectors

The system has two RS-422/485 & two RS-232 serial port connectors. The pinouts for the serial ports are listed in the table below. (**Table 4-25**)

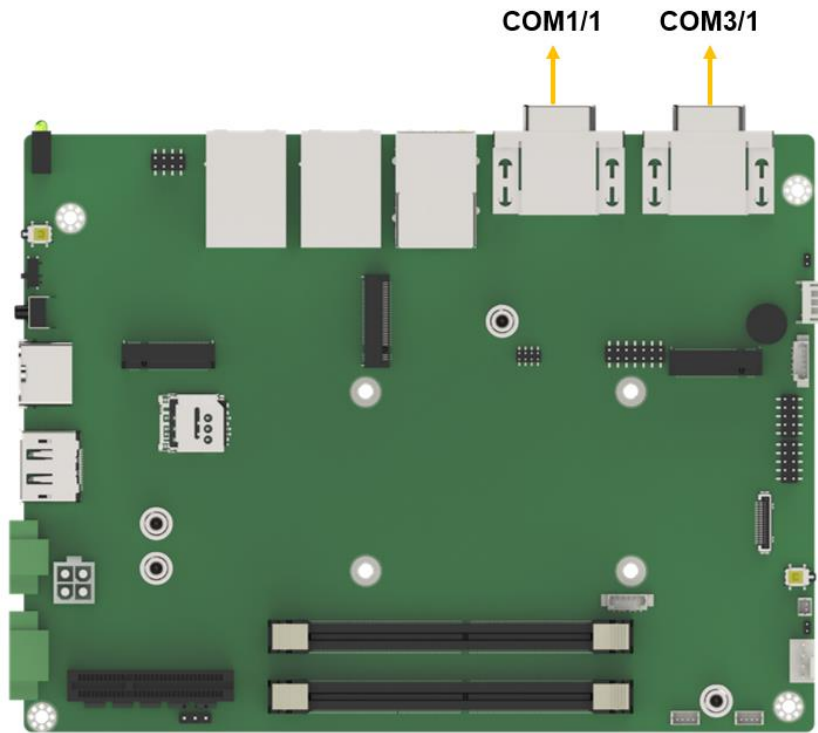

Figure 4-28: DB-9 RS-232/422/485 Serial Port Connectors Locations

PIN NO.	RS232	RS422	RS485
1	DCD#	TX-	TX-
2	RXD	TX+	TX+
3	TXD	RX+	
4	DTR#	RX-	
5	GND		
6	DSR#		
7	RTS#		
8	CTS#		
9	RI#		

Table 4-25: RS-232 (COM1/1) & RS-422/485 (COM3/1) Connector Pinouts

Chapter

5

BIOS

5.1 Introduction

The BIOS is programmed onto the BIOS chip. The BIOS setup program allows changes to certain system settings. This chapter outlines the options that can be changed.



NOTE:

Some of the BIOS options may vary throughout the life cycle of the product and are subject to change without prior notice.

5.1.1 Starting Setup

The UEFI BIOS is activated when the computer is turned on. The setup program can be activated in one of two ways.

1. **Using keyboard:** Press the **DEL** or **F2** as soon as the system is turned on.
2. **Using touchscreen:** Press the **Setup** button on the upper right corner of the BIOS Starting Menu.

If the message disappears before the **DEL** or **F2** key is pressed, restart the computer and try again, then the BIOS Starting Menu will appear. Select "Setup" and press Enter to get into the BIOS Setup.

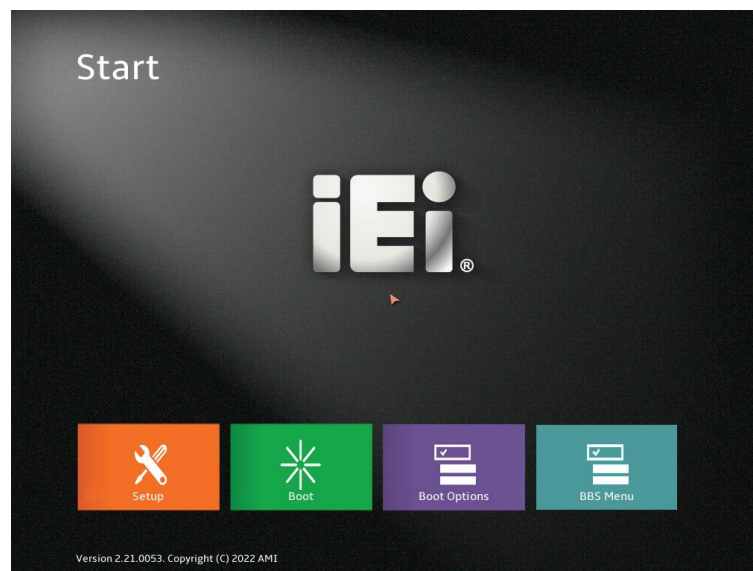

Figure 5-1: BIOS Starting Menu

5.1.2 Using Setup

The BIOS Setup menu can be navigated by using a keyboard or a touchscreen.

5.1.2.1 Keyboard Navigation

For keyboard navigation, use the navigation keys shown in (Figure 5-2).

Key	Function
Up arrow	Move to previous item
Down arrow	Move to next item
Left arrow	Move to the item on the left hand side
Right arrow	Move to the item on the right hand side
+	Increase the numeric value or make changes
-	Decrease the numeric value or make changes
Page Up	Move to the previous page
Page Dn	Move to the next page
Esc	Main Menu – Quit and not save changes into CMOS Status Page Setup Menu and Option Page Setup Menu -- Exit current page and return to Main Menu
F1	General help, only for Status Page Setup Menu and Option Page Setup Menu
F2	Load previous values
F3	Load optimized defaults
F4	Save changes and Exit BIOS
<K>	Scroll help area upwards
<M>	Scroll help area downwards

Figure 5-2: BIOS Navigation Keys

5.1.2.2 Touch Navigation

For touchscreen navigation, use the on-screen navigation keys shown below (**Figure 5-3**).

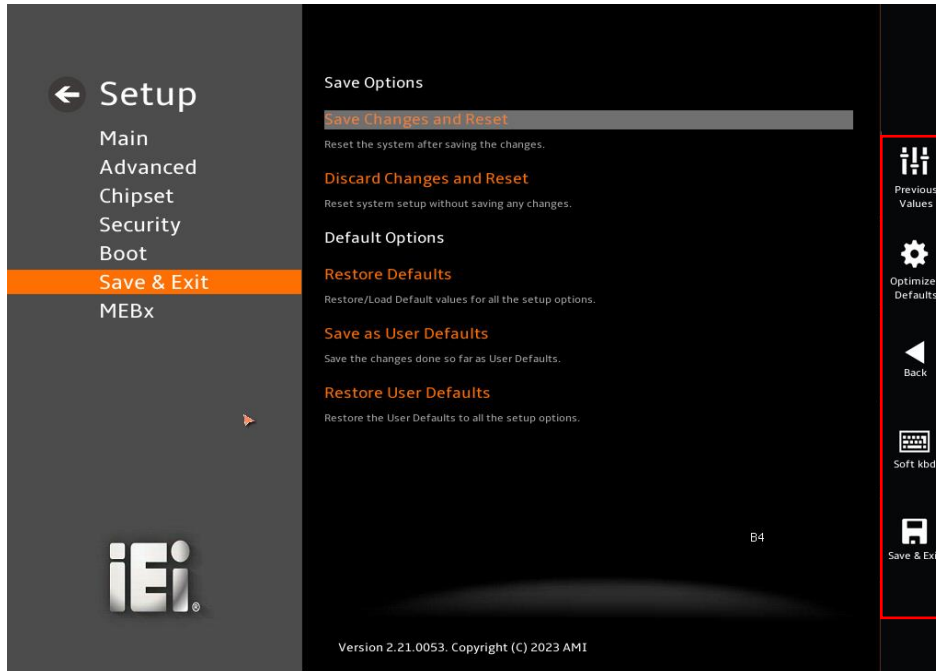

On-screen Button	Function
Previous Values	Load the last value you set.
Optimized Defaults	Load the factory default values in order to achieve the best performance.
Back	Return to the previous menu.
Soft kbd	Display the on-screen keyboard.
Save & Exit	Save the changes made to the BIOS options and reset the system.

Figure 5-3: BIOS On-screen Navigation Keys

5.1.3 Getting Help

When **F1** is pressed a small help window describing the appropriate keys to use and the possible selections for the highlighted item appears. To exit the Help Window, press the **Esc** key.

5.1.4 Unable to Reboot after Configuration Changes

If the computer cannot boot after changes to the system configuration is made, CMOS defaults. Use the clear CMOS button described in **Chapter 4**.

5.1.5 BIOS Menu Bar

The **menu bar** on top of the BIOS screen has the following main items:

- Main – Changes the basic system configuration.
- Advanced – Changes the advanced system settings.
- Chipset – Changes the chipset settings.
- Security – Sets User and Supervisor Passwords.
- Boot – Changes the system boot configuration.
- Save & Exit – Selects exit options and loads default settings
- MEBx – Support Intel AMT function

The following sections completely describe the configuration options found in the menu items at the top of the BIOS screen and listed above.

5.2 Main

The **Main** BIOS menu (**BIOS Menu 1 & BIOS Menu 2**) appears when the **BIOS Setup** program is entered. The **Main** menu gives an overview of the basic system information.

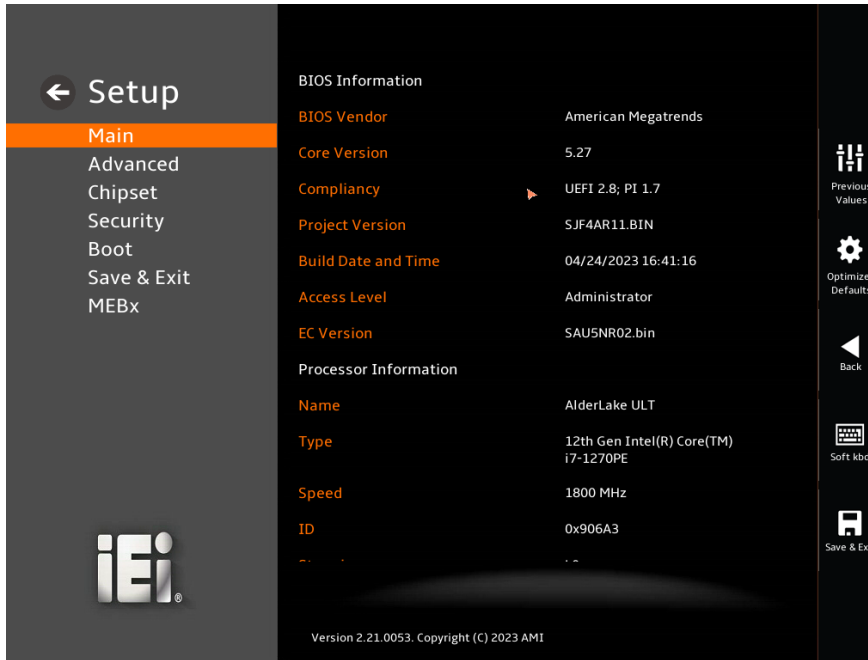

BIOS Menu 1: Main (1/2)

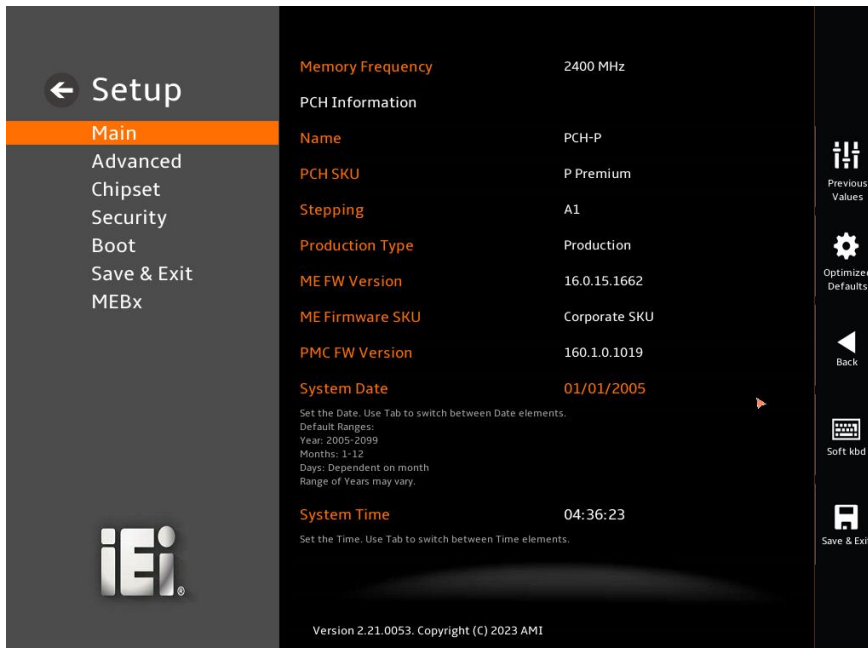

BIOS Menu 2: Main (2/2)

DRPC-242-ADL-P

→ BIOS Information

The **BIOS Information** lists a brief summary of the BIOS. The fields in **BIOS Information** cannot be changed. The items shown in the system overview include:

- **BIOS Vendor:** Installed BIOS vendor
- **Core Version:** Current BIOS version
- **Compliance:** Current UEFI & PI version
- **Project Version:** the board version
- **Build Date and Time:** Date the current BIOS version was created
- **EC Version:** Current EC version

→ Processor Information

The **Processor Information** lists a brief summary of the Processor. The fields in **Processor Information** cannot be changed. The items shown in the system overview include:

- **Name:** Displays the Processor Details
- **Type:** Displays the Processor Type
- **Speed:** Displays the Processor Speed
- **ID:** Displays the Processor ID
- **Stepping:** Displays the Processor Stepping
- **Number of Efficient-cores:** Displays number of CPU efficient-cores
- **Number of Processors:** Displays number of CPU cores
- **Microcode Revision:** CPU Microcode Revision
- **IGFX GOP Version:** Displays the IGFX GOP Version
- **Total Memory:** Total Memory in the System
- **Memory Frequency:** Displays the Frequency of Memory

→ PCH Information

The **PCH Information** lists a brief summary of the PCH. The fields in **PCH Information** cannot be changed. The items shown in the system overview include:

- **Name:** Displays the PCH Name
- **PCH SKU:** Displays the PCH SKU
- **Stepping:** Displays the PCH Stepping
- **Production Type:** Displays the Production Type
- **Dual Output Fast Read support:** Displays the Processor Details
- **Read ID/Status Clock Freq:** Displays the Read ID and Read Status Clock Frequency
- **ME FW Version:** Displays the ME Firmware Version
- **ME Firmware SKU:** Displays the ME Firmware SKU
- **PMC FW Version:** Displays the PMC Firmware Version

The System Overview field also has two user configurable fields:

→ **System Date [xx:xx:xx]**

Use the **System Date** option to set the system date. Manually enter the day, month and year.

→ **System Time [xx:xx:xx]**

Use the **System Time** option to set the system time. Manually enter the hours, minutes and seconds.

5.3 Advanced

Use the **Advanced** menu (**BIOS Menu 3 & BIOS Menu 4**) to configure the CPU and peripheral devices through the following sub-menus



WARNING!

Setting the wrong values in the sections below may cause the system to malfunction. Make sure that the settings made are compatible with the hardware.



BIOS Menu 3: Advanced (1/2)

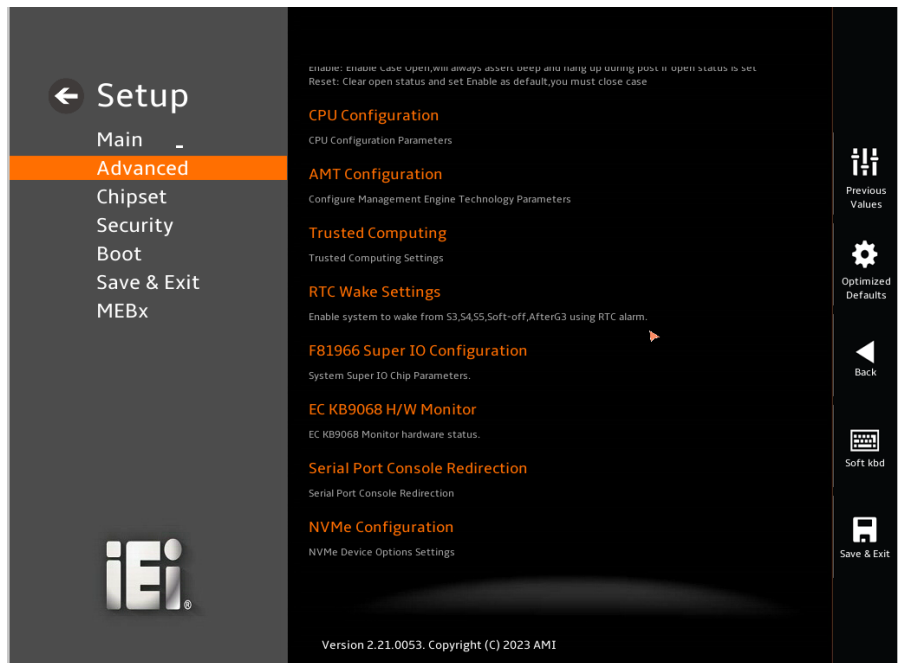

BIOS Menu 4: Advanced (2/2)

5.3.1 CPU Configuration

Use the **CPU Configuration** menu (**BIOS Menu 5 & BIOS Menu 6 & BIOS Menu 7**) to view detailed CPU specifications or enable the Intel Virtualization Technology.



BIOS Menu 5: CPU Configuration (1/3)



BIOS Menu 6: CPU Configuration (2/3)



BIOS Menu 7: CPU Configuration (3/3)

➔ **Efficient-core Information**

The **Efficient-core Information** displays the E-core Information.

- ➔ **L1 Data Cache** 32 KB x 8
- ➔ **L1 Instruction Cache** 64 KB x 8
- ➔ **L2 Cache** 2048 KB x 2
- ➔ **L3 Cache** 18 MB

➔ **Performance-core Information**

The **Performance-core Information** displays the P-core Information.

- ➔ **L1 Data Cache** 48 KB x 4
- ➔ **L1 Instruction Cache** 32 KB x 4
- ➔ **L2 Cache** 1280 KB x 4
- ➔ **L3 Cache** 18 MB

DRPC-242-ADL-P

→ Intel (VXM) Virtualization Technology [Enabled]

Use the **Intel (VMX) Virtualization Technology** option to enable or disable virtualization on the system. When enabled, a VMM can utilize the additional hardware capabilities provided by Vanderpool Technology.

- **Disabled** Disables Intel Virtualization Technology.
- **Enabled** **DEFAULT** Enables Intel Virtualization Technology.

→ Active Performance-cores [All]

Use the **Active Processor Cores** BIOS option to enable numbers of P-cores in the processor package.

- **All** **DEFAULT** Enable all cores in the processor package.
- **1** Enable one core in the processor package.
- **2** Enable two cores in the processor package.
- **3** Enable three cores in the processor package.

→ Active Efficient-cores [All]

Use the **Active Processor Cores** BIOS option to enable numbers of E-cores in the processor package.

- **All** **DEFAULT** Enable all cores in the processor package.
- **7** Enable seven cores in the processor package.
- **6** Enable six cores in the processor package.
- **5** Enable five cores in the processor package.
- **4** Enable four cores in the processor package.
- **3** Enable three cores in the processor package.
- **2** Enable two cores in the processor package.
- **1** Enable one core in the processor package.

→ 0 Enable zero core in the processor package.

→ **Hyper-Threading [Enabled]**

Use the **Hyper-Threading** option to enable or disable the Hyper-Threading Technology.

→ **Disabled** Disables Hyper-Threading Technology

→ **Enabled** **DEFAULT** Enables Hyper-Threading Technology

→ **Intel(R) SpeedStep(tm) [Enabled]**

Use the Intel(R) SpeedStep(tm) option to enable more than two frequency ranges to be supported.

→ **Disabled** Disables more than two frequency ranges

→ **Enabled** **DEFAULT** Enables more than two frequency ranges

→ **C states [Disabled]**

Use **C states** option to enable or disable CPU Power Management. Allows CPU to go to C states when it's not 100% utilized

→ **Disabled** **DEFAULT** Disables CPU to go to C states when it's not 100% utilized.

→ **Enabled** Enables CPU to go to C states when it's not 100% utilized.

→ **Power Limit 1 [0]**

Use the + or – key to change the **Power Limit 1** value. BIOS will program the default values for Limit 1 and Power Limit 1 Time Window. For 12.50W, enter 12500.

→ **Power Limit 2 [0]**

Use the + or – key to change the **Power Limit 2** value. BIOS will round to the nearest 1/8W when programming. 0 = no custom override. For 12.50W, enter 12500.

DRPC-242-ADL-P

➔ **Power Limit 1 Time Window [0]**

Use the **Power Limit 1 Time Window** option to select the PL1 time duration. The value may vary from 0 to 128. For 0 is the default value

➔ **Turbo Mode [Enabled]**

Use the **Turbo Mode** option to enable or disable Turbo Mode which requires Intel Speed Step or Intel Speed Shift to be available and enabled.

- ➔ **Disabled** Disables Turbo Mode Technology
- ➔ **Enabled** **DEFAULT** Enables Turbo Mode Technology

5.3.2 AMT Configuration

Use the **AMT Configuration** menu (**BIOS Menu 8**) to configure settings Intel AMT Supported configurations



BIOS Menu 8:AMT Configuration

➔ **Intel AMT [Enable]**

Use the **Intel AMT** option to enable or disable access MEBx Setup supported.

- ➔ **Disabled** Disables Intel AMT are no supported MEBx Setup
- ➔ **Enabled** **DEFAULT** Enables Intel AMT are able to access MEBx Setup

➔ **Unconfigure ME**

The **Unconfigure ME** with resetting MEBx Password to default on next boot

5.3.3 Trusted Computing

Use the **Trusted Computing** menu (**BIOS Menu 9**) to configure settings related to the Trusted Computing Group (TCG) Trusted Platform Module (TPM).



BIOS Menu 9: Trusted Computing

➔ **Security Device Support [Enable]**

Use the **Security Device Support** option to configure support for the TPM.

DRPC-242-ADL-P

- ➔ **Disable** TPM support is disabled.
- ➔ **Enable** **DEFAULT** TPM support is enabled.

➔ Pending Operation [None]

Use the **Pending Operation** option to schedule an operation for the security device.

- ➔ **None** **DEFAULT** TPM information is previous.S
- ➔ **TPM Clear** TPM information is cleared

5.3.4 RTC Wake Settings

Use the **RTC Wake Settings** menu (**BIOS Menu 10**) to enable or disable System wake on alarm event.



BIOS Menu 10: RTC Wake Settings

- ➔ **Disabled** **DEFAULT** Disable System wake on alarm event.
- ➔ **Enabled** System will wake on the date::hr::min::sec specified.

5.3.5 F81966 Super IO Configuration

Use the **F81966 Super IO Configuration** menu (**BIOS Menu 11**) to set or change the configurations for the serial ports.



BIOS Menu 11: F81966 Super IO Configuration

DRPC-242-ADL-P

5.3.5.1 Serial Port 1 Configuration

Use the **Serial Port 1 Configuration** menu (**BIOS Menu 12**) to configure the serial port 1.

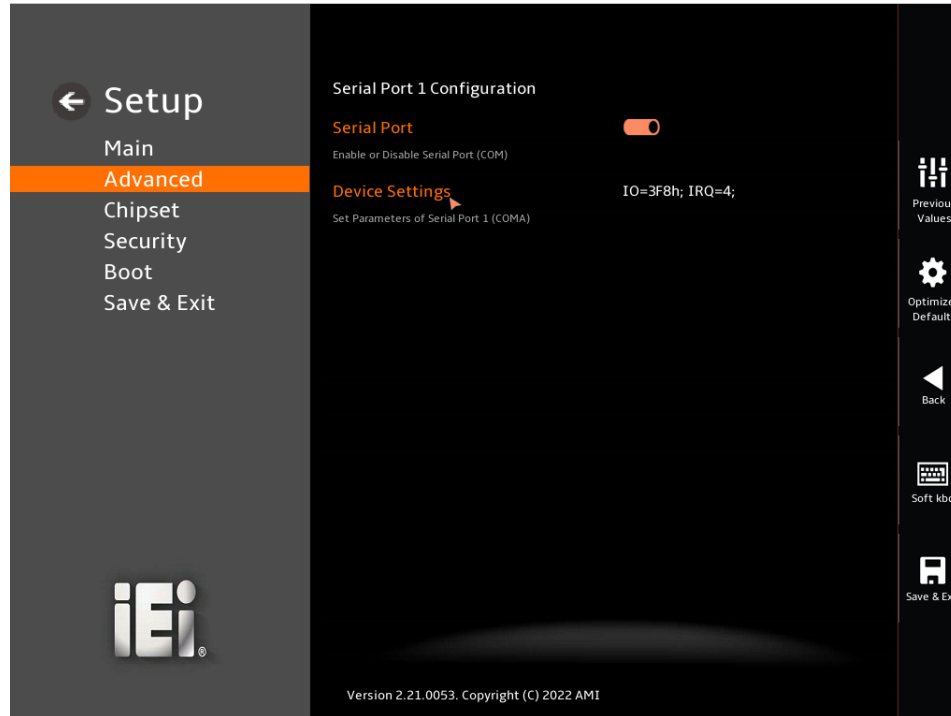

BIOS Menu 12: Serial Port 1 Configuration Menu

→ Serial Port [Enabled]

Use the **Serial Port** option to enable or disable the serial port.

- **Disabled** Disable the serial port
- **Enabled** **DEFAULT** Enable the serial port

→ Device Settings

The **Device Settings** option shows the serial port IO port address and interrupt address.

- **IO=3F8h;** Serial Port I/O port address is 3F8h and the interrupt
IRQ=4 address is IRQ4

5.3.5.2 Serial Port 2 Configuration

Use the **Serial Port 2 Configuration** menu (**BIOS Menu 13**) to configure the serial port 2.

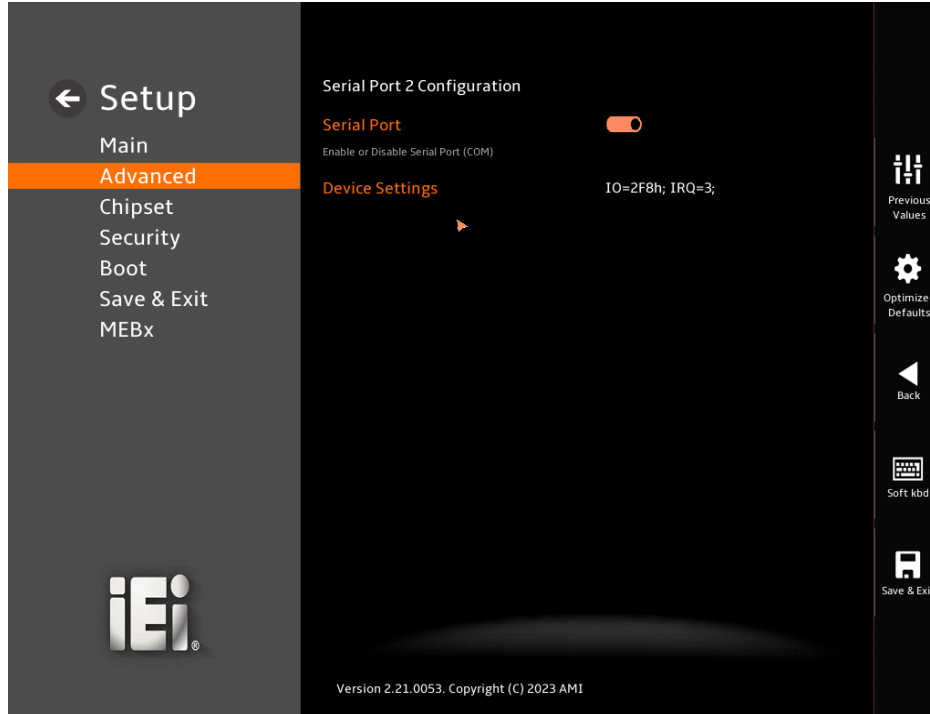

BIOS Menu 13: Serial Port 2 Configuration Menu

➔ Serial Port [Enabled]

Use the **Serial Port** option to enable or disable the serial port.

- ➔ **Disabled** Disable the serial port
- ➔ **Enabled** **DEFAULT** Enable the serial port

➔ Device Settings

The **Device Settings** option shows the serial port IO port address and interrupt address.

- ➔ **IO=2F8h;** Serial Port I/O port address is 2F8h and the interrupt
IRQ=3 address is IRQ3

DRPC-242-ADL-P

5.3.5.3 Serial Port 3 Configuration

Use the **Serial Port 3 Configuration** menu (**BIOS Menu 14**) to configure the serial port 3.

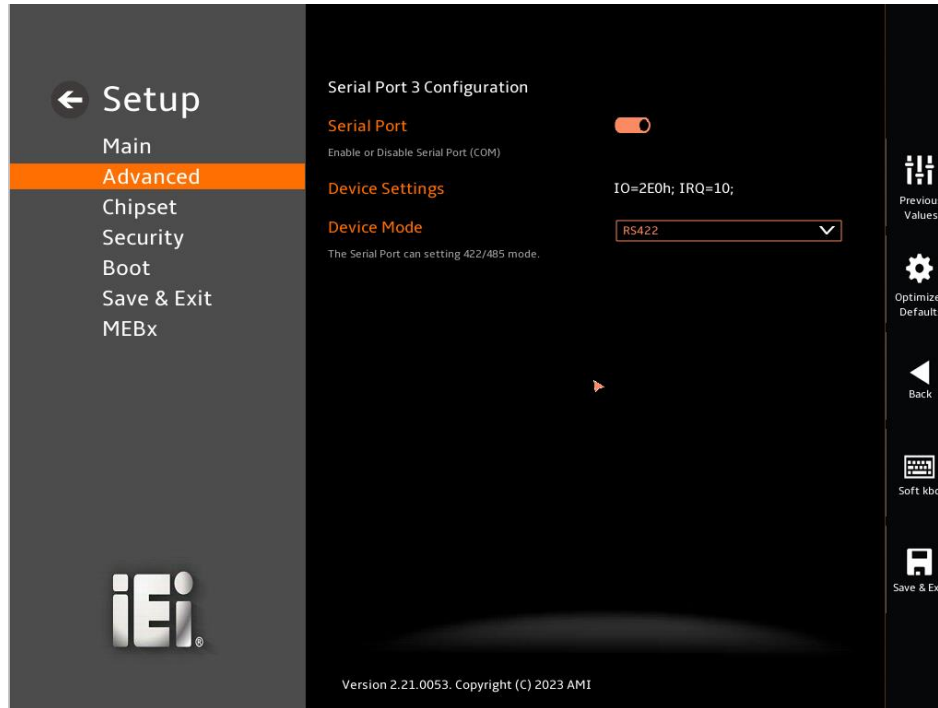

BIOS Menu 14: Serial Port 3 Configuration Menu

→ Serial Port [Enabled]

Use the **Serial Port** option to enable or disable the serial port.

- **Disabled** Disable the serial port
- **Enabled DEFAULT** Enable the serial port

→ Device Settings

The **Device Settings** option shows the serial port IO port address and interrupt address.

- **IO=2E0h;** Serial Port I/O port address is 2E0h and the interrupt
IRQ=10 address is IRQ10

→ Serial Port Mode [RS422]

Use the **Serial Port Mode** option to set RS422/485 mode.

- ➔ **RS422** Serial Port Mode is RS422 mode
- ➔ **RS485** Serial Port Mode is RS485 mode

5.3.5.4 Serial Port 4 Configuration

Use the **Serial Port 3 Configuration** menu (**BIOS Menu 15**) to configure the serial port 4

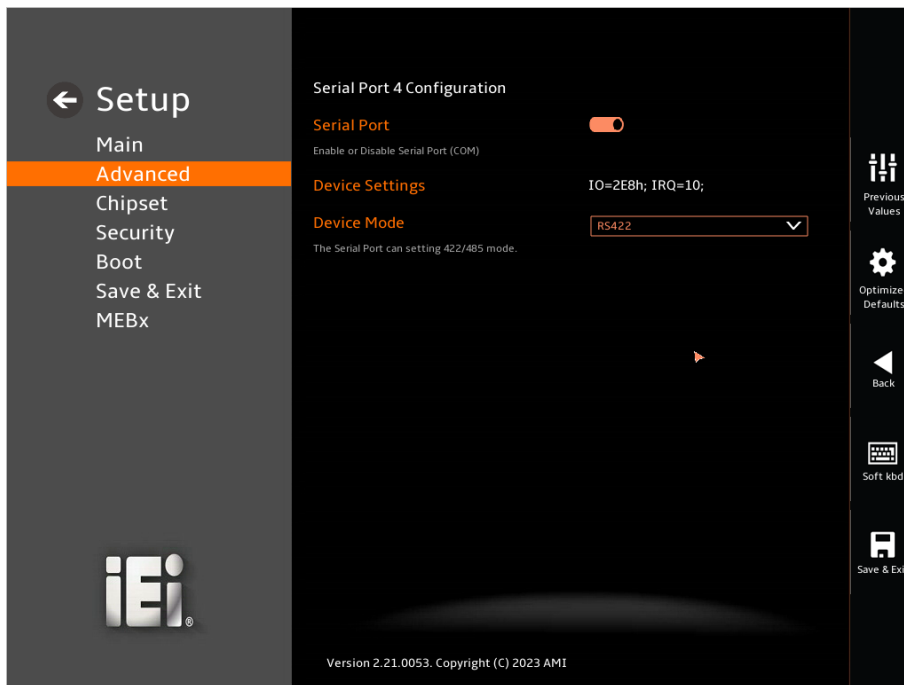

BIOS Menu 15: Serial Port 4 Configuration Menu

➔ **Serial Port [Enabled]**

Use the **Serial Port** option to enable or disable the serial port.

- ➔ **Disabled** Disable the serial port
- ➔ **Enabled** **DEFAULT** Enable the serial port

➔ **Device Settings**

The **Device Settings** option shows the serial port IO port address and interrupt address.

DRPC-242-ADL-P

→ **IO=2E8h;** Serial Port I/O port address is 2E8h and the interrupt
IRQ=10 address is IRQ10

→ **Serial Port Mode [RS422]**

Use the **Serial Port Mode** option to set RS/422/485 mode.

→ **RS422** Serial Port Mode is RS422 mode

→ **RS485** Serial Port Mode is RS485 mode

5.3.5.5 Serial Port 5 Configuration

Use the **Serial Port 3 Configuration** menu (**BIOS Menu 16**) to configure the serial port 5

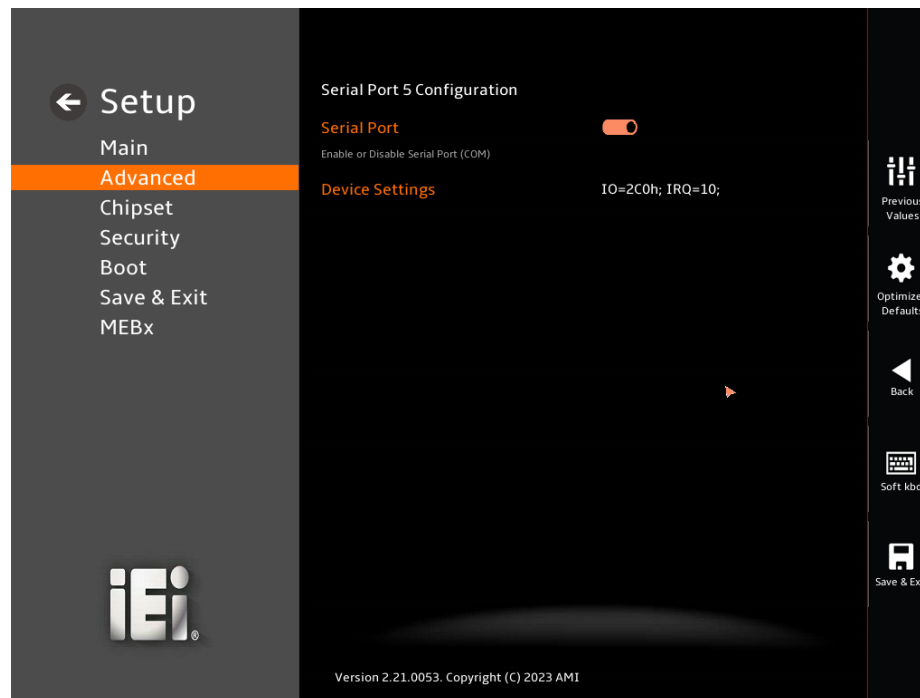
**BIOS Menu 16: Serial Port 5 Configuration Menu**

→ **Serial Port [Enabled]**

Use the **Serial Port** option to enable or disable the serial port.

- ➔ **Disabled** Disable the serial port
- ➔ **Enabled** **DEFAULT** Enable the serial port

➔ **Device Settings**

The **Device Settings** option shows the serial port IO port address and interrupt address.

- ➔ **IO=2C0h;** Serial Port I/O port address is 2C0h and the interrupt
IRQ=10 address is IRQ10

5.3.5.6 Serial Port 6 Configuration

Use the **Serial Port 3 Configuration** menu (**BIOS Menu 17**) to configure the serial port 6

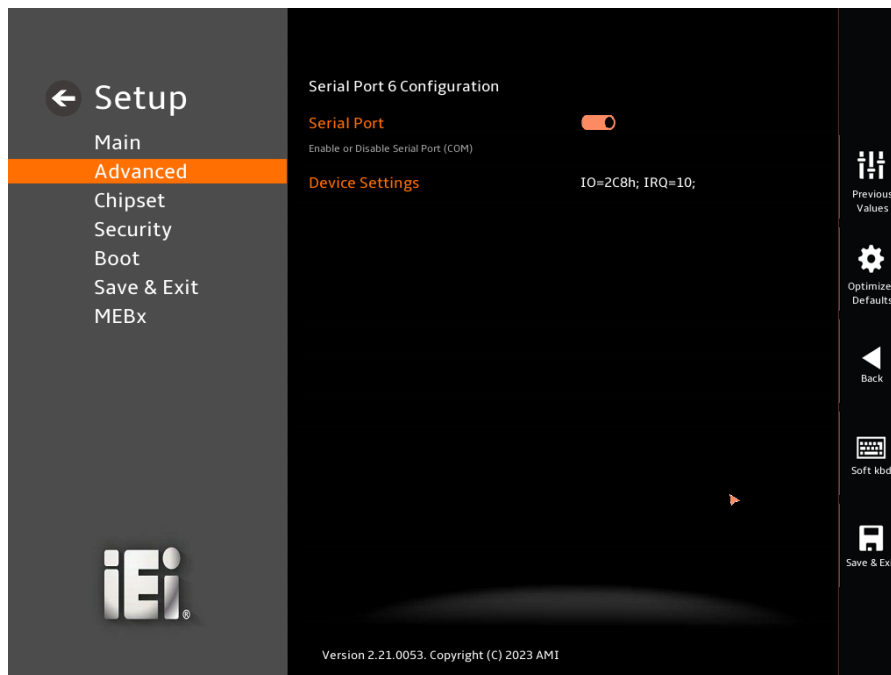

BIOS Menu 17: Serial Port 6 Configuration Menu

➔ **Serial Port [Enabled]**

Use the **Serial Port** option to enable or disable the serial port.

DRPC-242-ADL-P

- ➔ Disabled Disable the serial port
- ➔ Enabled **DEFAULT** Enable the serial port

➔ Device Settings

The **Device Settings** option shows the serial port IO port address and interrupt address.

- ➔ **IO=2C8h;** Serial Port I/O port address is 2C8h and the interrupt
IRQ=10 address is IRQ10

5.3.6 EC KB9068 H/W Monitor

The **EC KB9068 H/W Monitor** menu (**BIOS Menu 18**) contains the smart fan mode configuration submenu and shows the state of H/W real-time operating temperature, fan speeds and system voltages.

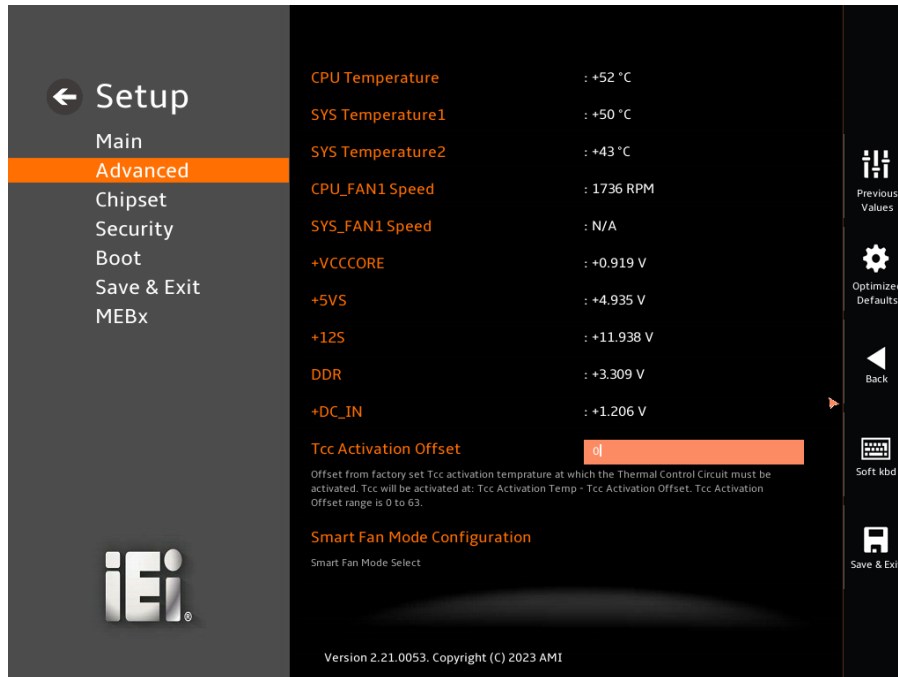

BIOS Menu 18: EC KB9068 H/W Monitor

→ PC Health Status

The following system parameters and values are shown. The system parameters that are monitored are:

- CPU Temperature
- System Temperatures
 - System Temperature1
 - System Temperature2
- CPU_FAN1 Speed
- SYS_FAN1 Speed
- Voltages:
 - +VCCCORE
 - +V5S
 - +V12S
 - +DDR
 - +DC_IN

→ Tcc Activation Offset [0]

Offset from factory set Tcc activation temperature at which the Thermal Control Circuit must be activated. Tcc will be activated at: Tcc Activation Temp – Tcc Activation Offset. Tcc Activation Offset range is 0 to 63

DRPC-242-ADL-P

5.3.6.1 Smart Fan Mode Configuration

Use the **Smart Fan Mode Configuration** submenu (**BIOS Menu 19&BIOS Menu 20**) to configure the CPU/system fan start/off temperature and control mode.

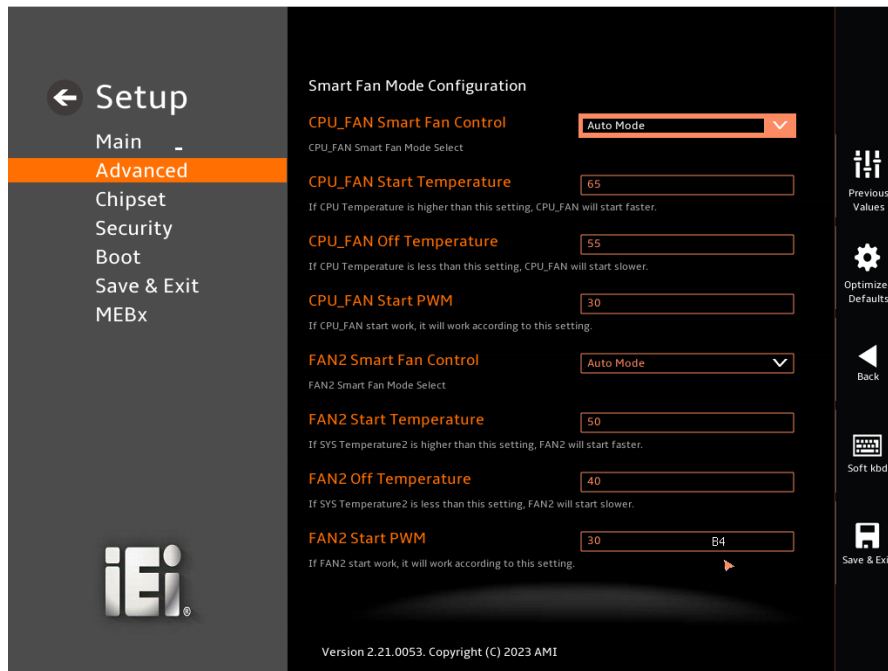

BIOS Menu 19: Smart Fan Mode Configuration (1/2)

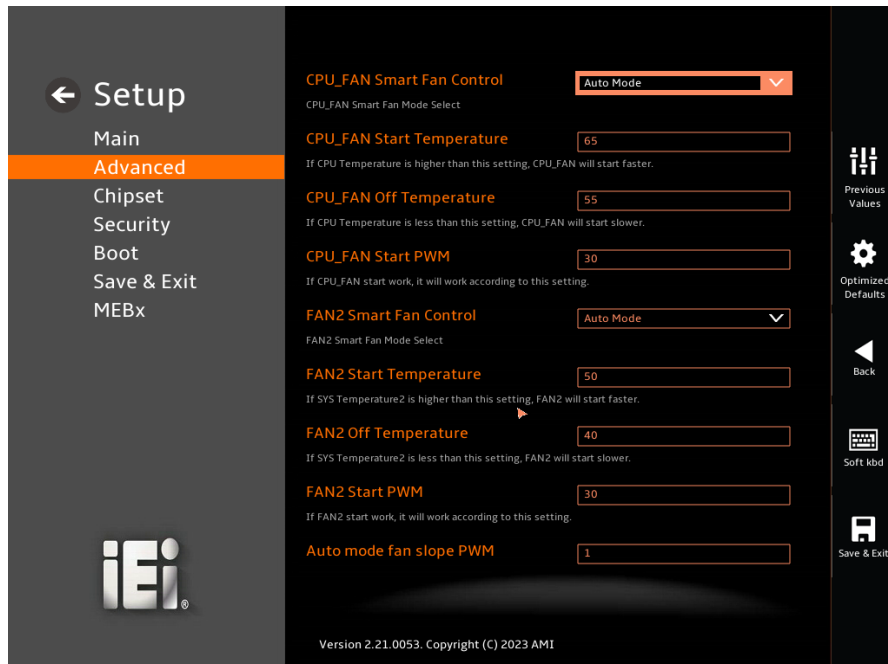

BIOS Menu 20: Smart Fan Mode Configuration (2/2)

→ **CPU_FAN Smart Fan Control [Auto Mode]**

Use the **CPU_FAN Smart Fan Control** option to configure the CPU Smart Fan.

- **Manual Mode** The fan spins at the speed set in Manual Mode settings.
- **Auto Mode** **DEFAULT** The fan adjusts its speed using Auto Mode settings.

→ **CPU_FAN Start Temperature [65]**

If the CPU temperature is higher than this setting, CPU_FAN will start faster. Use the + or – key to change the value or enter a decimal number between 1 and 100.

→ **CPU_FAN Off Temperature [55]**

If the CPU temperature is lower than the value set this option, the fan speed change to be lowest. To set a value, Use the + or – key to change the value or enter a decimal number between 1 and 100.

→ **CPU_FAN Start PWM [30]**

Use the **CPU_FAN1 Start PWM** option to set the PWM start value. Use the + or – key to change the value or enter a decimal number between 1 and 100.

→ **FAN2 Smart Fan Control [Auto Mode]**

Use the **FAN2 Smart Fan Control** option to configure the CPU Smart Fan.

- **Manual Mode** The fan spins at the speed set in Manual Mode settings.
- **Auto Mode** **DEFAULT** The fan adjusts its speed using Auto Mode settings.

→ **FAN2 Start Temperature [50]**

If the System temperature2 is higher than this setting, FAN2 will start faster. Use the + or – key to change the value or enter a decimal number between 1 and 100.

DRPC-242-ADL-P**→ FAN2 Off Temperature [40]**

If the System temperature2 is lower than the value set this option, the FAN2 speed change to be lowest. To set a value, Use the + or – key to change the value or enter a decimal number between 1 and 100.

→ FAN2 Start PWM [30]

Use the **FAN2 Start PWM** option to set the PWM start value. Use the + or – key to change the value or enter a decimal number between 1 and 100.

→ Auto mode fan slope PWM

Use the **Auto mode fan slope PWM** option to select the linear rate at which the PWM mode increases with respect to an increase in temperature. Use the + or – key to change the value or enter a decimal number between 1 and 8

5.3.7 Serial Port Console Redirection

The **Serial Port Console Redirection** menu (**BIOS Menu 21& BIOS Menu 22&BIOS Menu 23**) allows the console redirection options to be configured. Console Redirection allows users to maintain a system remotely by re-directing keyboard input and text output through the serial port.

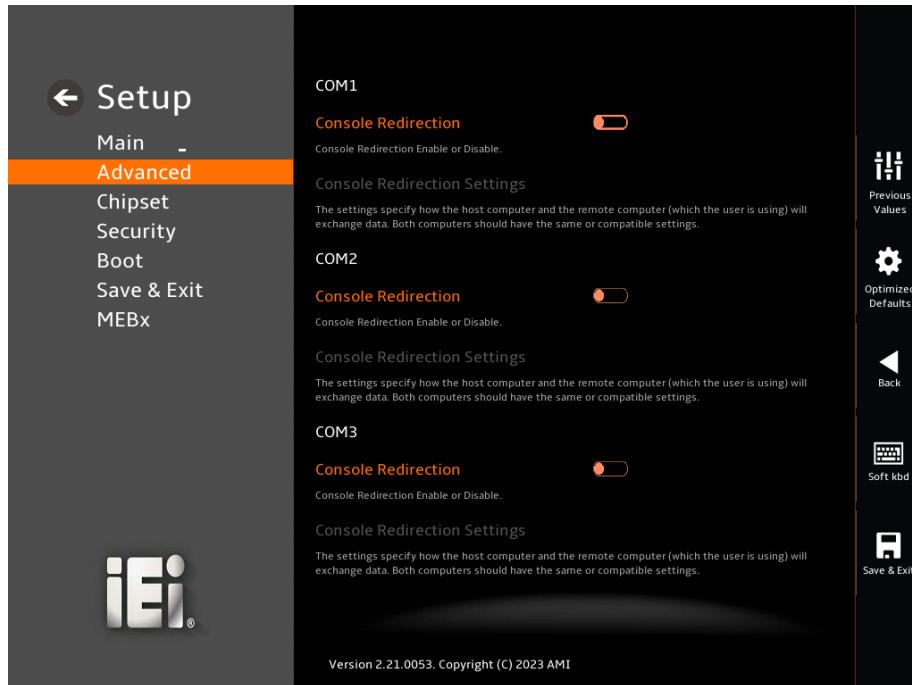

BIOS Menu 21: Serial Port Console Redirection (1/3)

DRPC-242-ADL-P

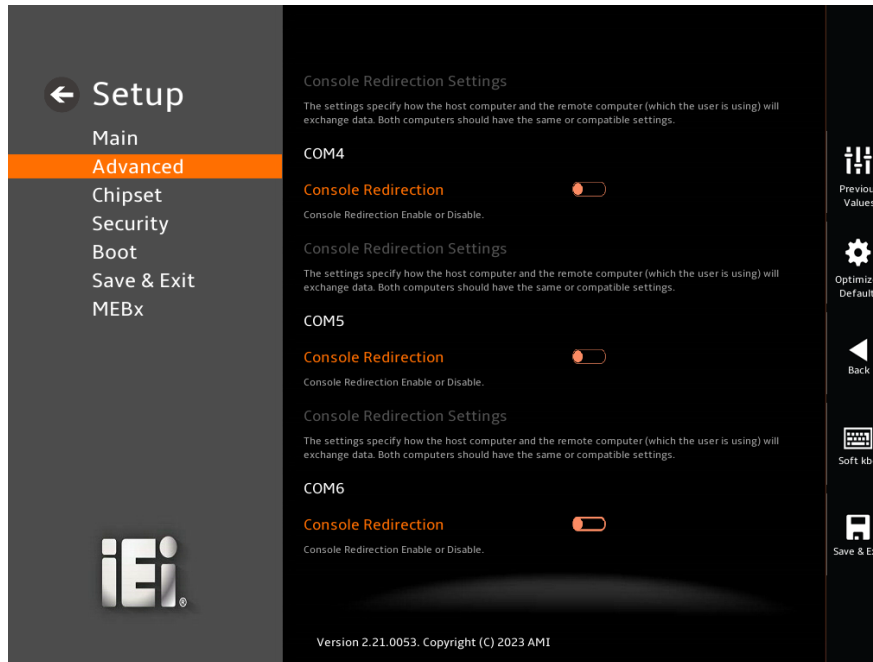

BIOS Menu 22: Serial Port Console Redirection (2/3)

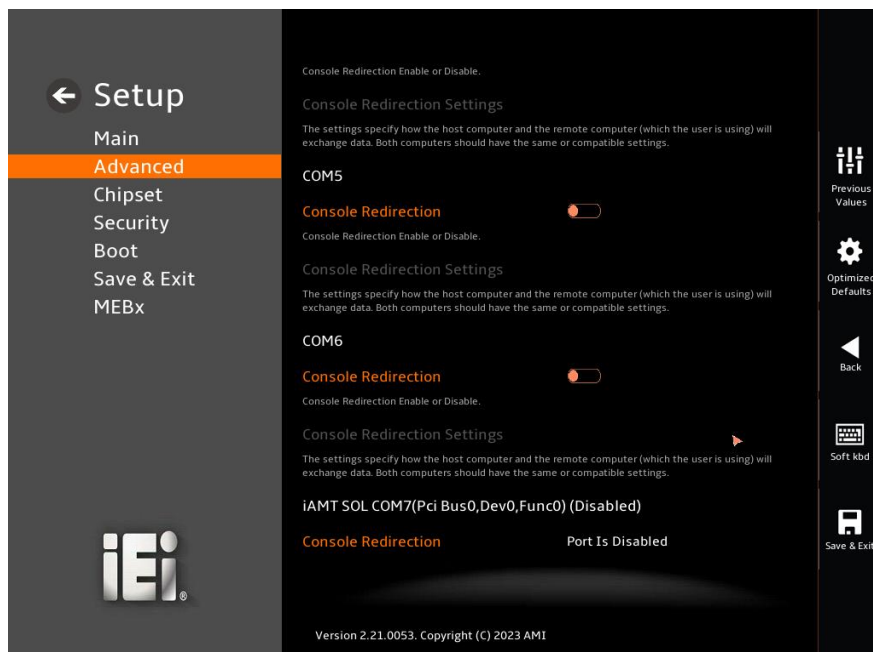

BIOS Menu 23: Serial Port Console Redirection (3/3)

➔ **Console Redirection [Disabled]**

Use **Console Redirection** option to enable or disable the console redirection function.

➔ **Disabled** **DEFAULT** Disabled the console redirection function

➔ **Enabled** Enabled the console redirection function

The **Console Redirection Settings** submenu will be available when the **Console Redirection** option is enabled.

➔ **iAMT SOL COM7 (Pci Bus0,Dev0,Func0) [Disabled]**

Console Redirection port is Disabled

5.3.7.1 Console Redirection Settings

The following options are available in the **Console Redirection Settings** submenu (**BIOS Menu 24**) when the **COM Console Redirection** (for COM1 to COM6) option is enabled.

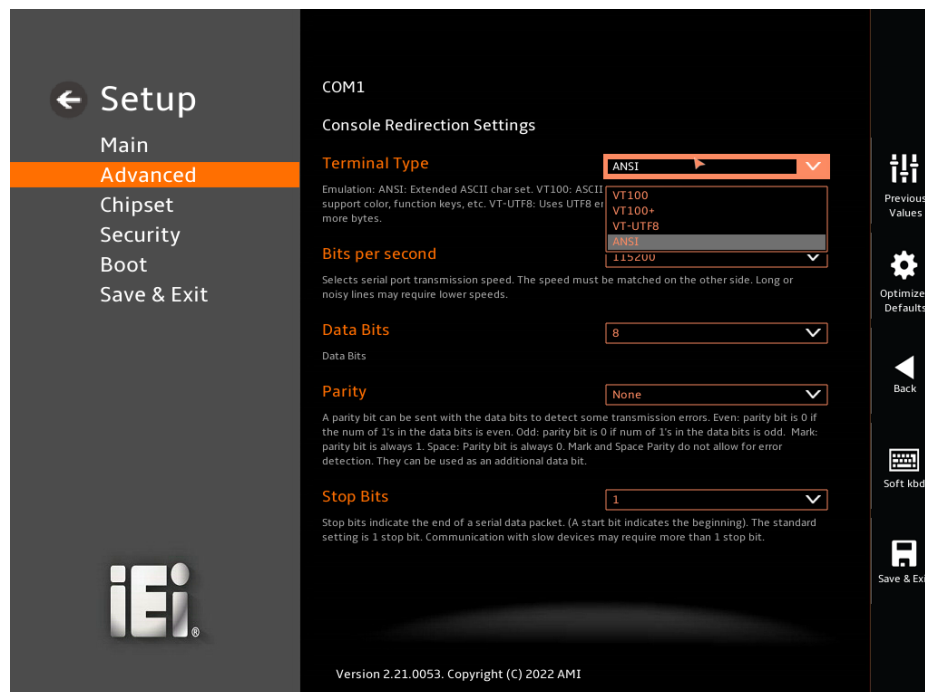

BIOS Menu 24: COM Console Redirection Settings

➔ **Terminal Type [ANSI]**

Use the **Terminal Type** option to specify the remote terminal type.

➔ **VT100** The target terminal type is VT100

DRPC-242-ADL-P

- **VT100+** The target terminal type is VT100+
- **VT-UTF8** The target terminal type is VT-UTF8
- **ANSI** **DEFAULT** The target terminal type is ANSI

→ **Bits per second [115200]**

Use the **Bits per second** option to specify the serial port transmission speed. The speed must match on the other side. Long or noisy lines may require lower speeds.

- **9600** Sets the serial port transmission speed at 9600.
- **19200** Sets the serial port transmission speed at 19200.
- **38400** Sets the serial port transmission speed at 38400.
- **57600** Sets the serial port transmission speed at 57600.
- **115200** **DEFAULT** Sets the serial port transmission speed at 115200.

→ **Data Bits [8]**

Use the **Data Bits** option to specify the number of data bits.

- **7** Sets the data bits at 7.
- **8** **DEFAULT** Sets the data bits at 8.

→ **Parity [None]**

Use the **Parity** option to specify the parity bit that can be sent with the data bits for detecting the transmission errors.

- **None** **DEFAULT** No parity bit is sent with the data bits.
- **Even** The parity bit is 0 if the number of ones in the data bits is even.
- **Odd** The parity bit is 0 if the number of ones in the data bits is odd.

→ **Mark** The parity bit is always 1. This option does not allow for error detection.

→ **Space** The parity bit is always 0. This option does not allow for error detection.

→ **Stop Bits [1]**

Use the **Stop Bits** option to specify the number of stop bits used to indicate the end of a serial data packet. Communication with slow devices may require more than 1 stop bit.

→ **1** **DEFAULT** Sets the number of stop bits at 1.

→ **2** Sets the number of stop bits at 2.

5.3.8 NVMe Configuration

Use the **NVMe Configuration (BIOS Menu 25)** menu to display the NVMe controller and device information.



BIOS Menu 25: NVMe Configuration

5.4 Chipset

Use the **Chipset** menu (**BIOS Menu 26**) to access the PCH IO and System Agent (SA) configuration menus.



WARNING!

Setting the wrong values for the Chipset BIOS selections in the Chipset BIOS menu may cause the system to malfunction.

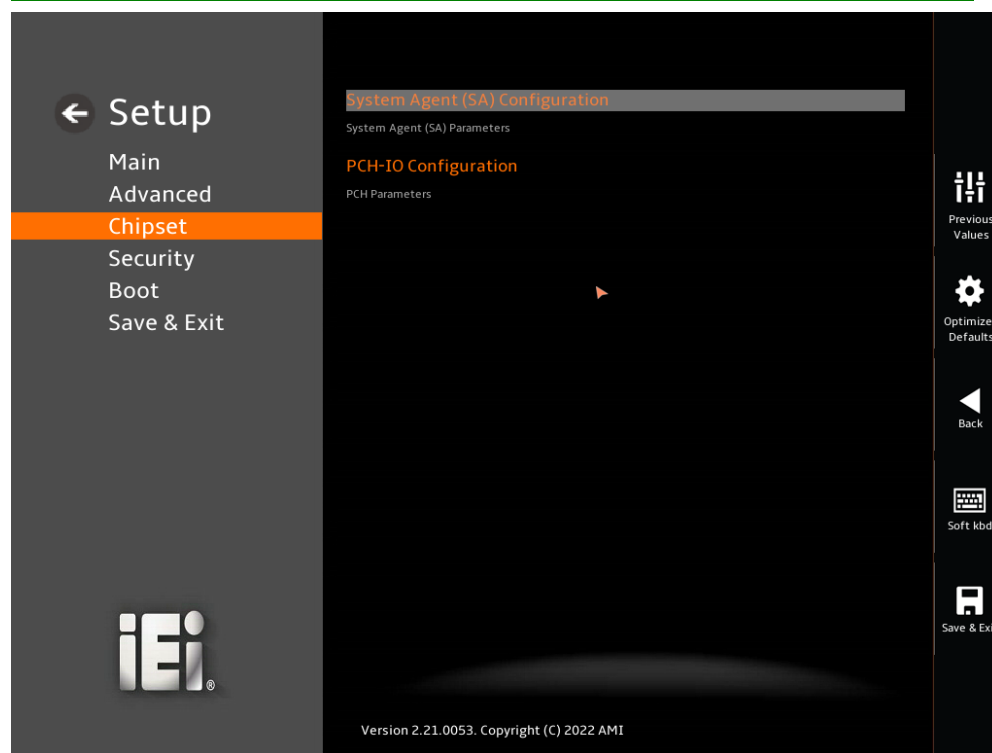

BIOS Menu 26: Chipset

5.4.1 System Agent (SA) Configuration

Use the **System Agent (SA) Configuration** menu (**BIOS Menu 27**) to configure the System Agent (SA) parameters.

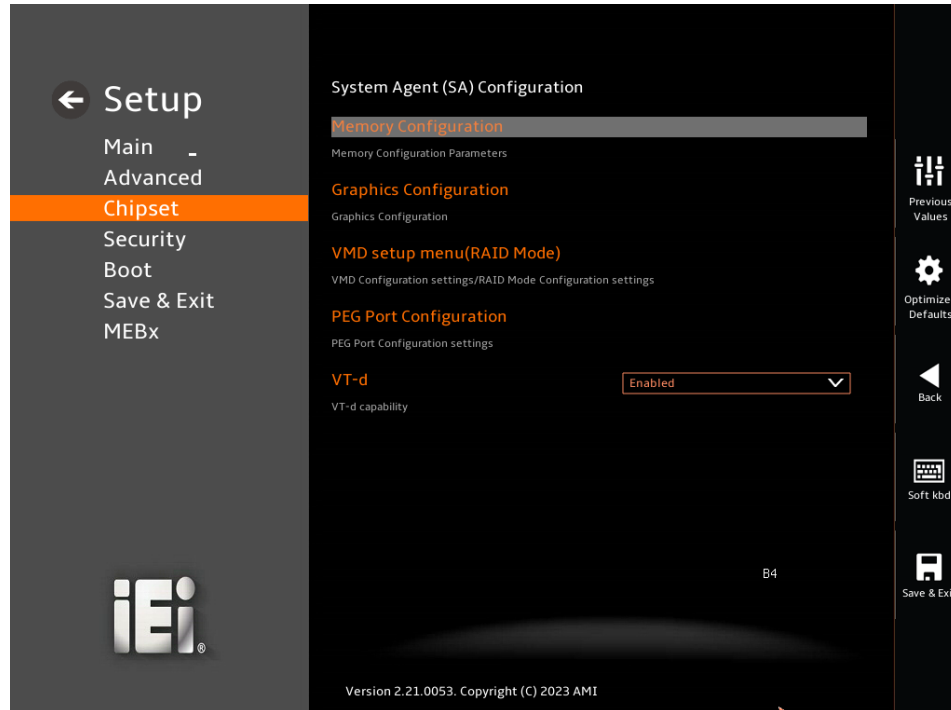

BIOS Menu 27: System Agent (SA) Configuration

→ VT-d [Enabled]

Use the **VT-d** option to enable or disable the VT-d capability.

- **Disabled** Disable the VT-d capability
- **Enabled** **DEFAULT** Enable the VT-d capability

5.4.1.1 Memory Configuration

Use the **Memory Configuration** submenu (**BIOS Menu 28**) to view memory information.

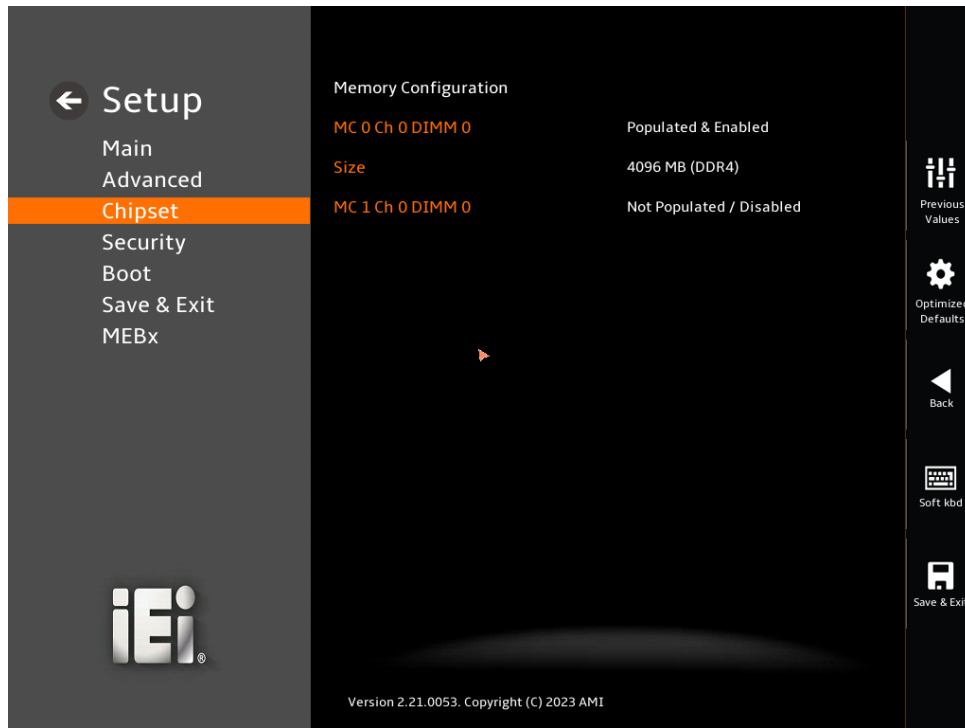

BIOS Menu 28: Memory Configuration

5.4.1.2 Graphics Configuration

Use the **Graphics Configuration (BIOS Menu 29)** menu to configure the video device connected to the system.

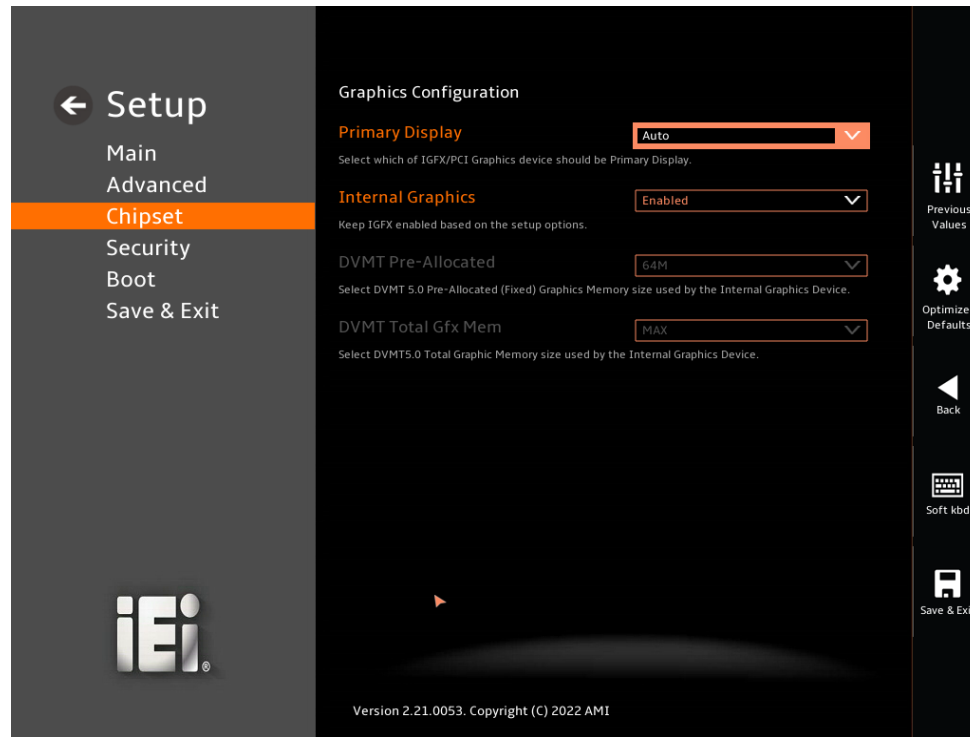

BIOS Menu 29: Graphics Configuration

→ Primary Display [Auto]

Use the **Primary Display** option to select the primary graphics controller the system uses.

The following options are available:

- Auto **Default**
- IGFX
- PEG
- PCI
- SG

→ Internal Graphics [Enabled]

Use the **Internal Graphics** option to configure whether to keep IGFX enabled. If user wants to support dual display by internal graphics and external graphics, this Internal

Graphics option should be set to Enabled and the above Primary Display option should be set to IGFX.

- ➔ **Auto** Auto mode
- ➔ **Disabled** Disables IGFX.
- ➔ **Enabled** **Default** Enables IGFX.

5.4.1.3 VMD setup menu (RAID Mode)

Use the **VMD setup menu (RAID Mode) (BIOS Menu 30)** to configure the VMD settings and RAID Mode settings.



BIOS Menu 30: VMD setup menu (RAID Mode)

- ➔ **Disabled** **DEFAULT** Disable to VMD controller
- ➔ **Enabled** Enable to VMD controller

5.4.1.4 PEG Port Configuration

Use the **PEG Port Configuration** submenu (**BIOS Menu 31**) to configure the PEG ports

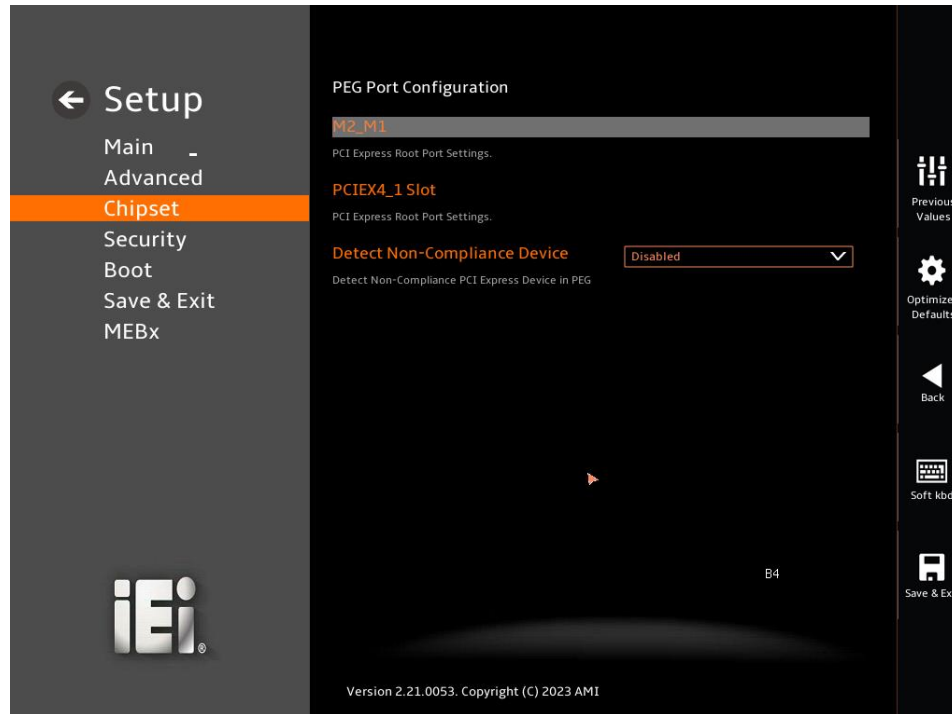

BIOS Menu 31: PEG Port Configuration

5.4.1.4.1 M2_M1

Use the **M2_M1** submenu (**BIOS Menu 32**) to configure the PCI Root Port Setting



BIOS Menu 32: M2_M1

→ M2_M1 [Enabled]

Use the **M2_M1** option to control the PCI Express Root Port

- **Disabled** Control PCI Express Root Port disabled
- **Enabled** **DEFAULT** Control PCI Express Root Port enabled

→ PCIe Speed [Auto]

Use the **PCIe Speed** option to specify the PCI Express port speed. Configuration options are listed below.

- **Auto** **DEFAULT** Auto mode.
- **Gen1** Configure PCIe Speed to Gen1.
- **Gen2** Configure PCIe Speed to Gen2.

DRPC-242-ADL-P

➔ Gen3 Configure PCIe Speed to Gen3.

5.4.1.4.2 PCIEX4_1 Slot

Use the **PCIEX4_1 Slot** menu (**BIOS Menu 33**) to control the PCI Express Root port.

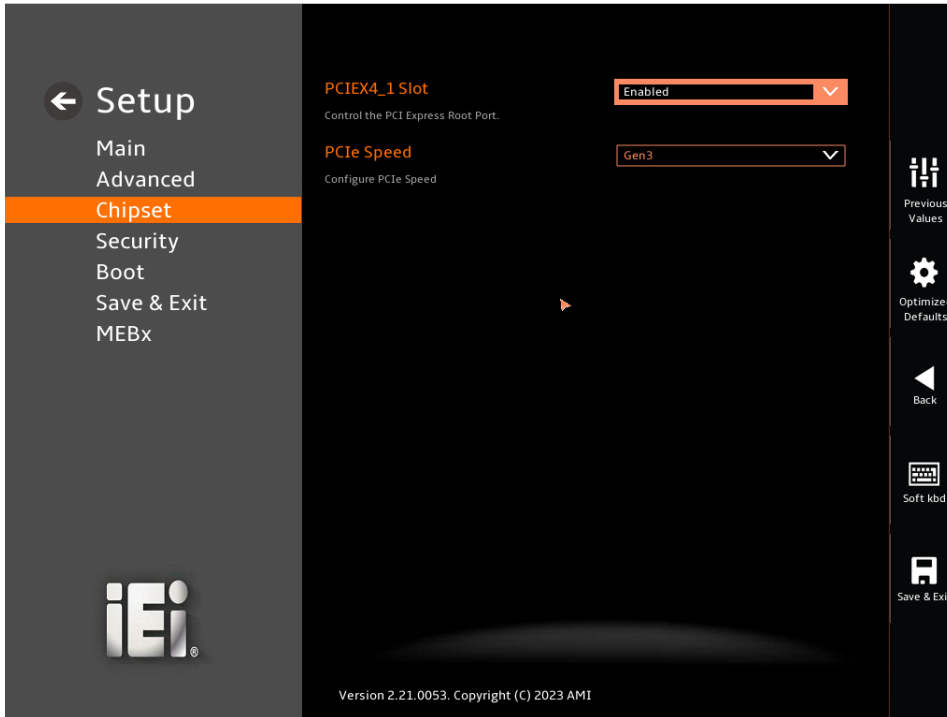

BIOS Menu 33: PCIEX4_1 Slot

➔ **PCIEX4_1 Slot [Enabled]**

Use the **PCIEX4_1 Slot** option to control the PCI Express Root Port.

- ➔ **Enabled** **DEFAULT** Control PCI Express Root Port disabled
- ➔ **Disabled** Control PCI Express Root Port enabled

➔ **PCIe Speed [Gen3]**

Use the **PCIe Speed** option to specify the PCI Express port speed. Configuration options are listed below.

- ➔ **Auto** Auto mode.

- **Gen1** Configure PCIe Speed to Gen1.
- **Gen2** Configure PCIe Speed to Gen2.
- **Gen3** **DEFAULT** Configure PCIe Speed to Gen3.

→ **Detect Non-Compliance Device [Disabled]**

Use the **Detect Non-Compliance Device** option to detect the Non-Compliance PCI Express Device in PEG

- **Enabled** The Non-Compliance PCI Express Device in PEG is enabled
- **Disabled** **DEFAULT** The Non-Compliance PCI Express Device in PEG is disabled

5.4.2 PCH-IO Configuration

Use the **PCI-IO Configuration** menu (**BIOS Menu 34&BIOS Menu 35**)to configure the PCH Parameters

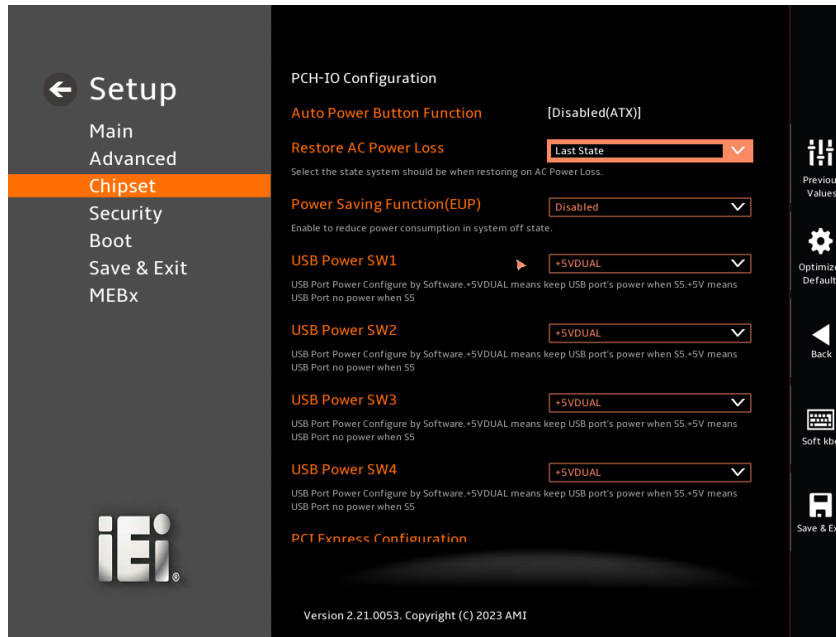

BIOS Menu 34: PCI-IO Configuration (1/2)

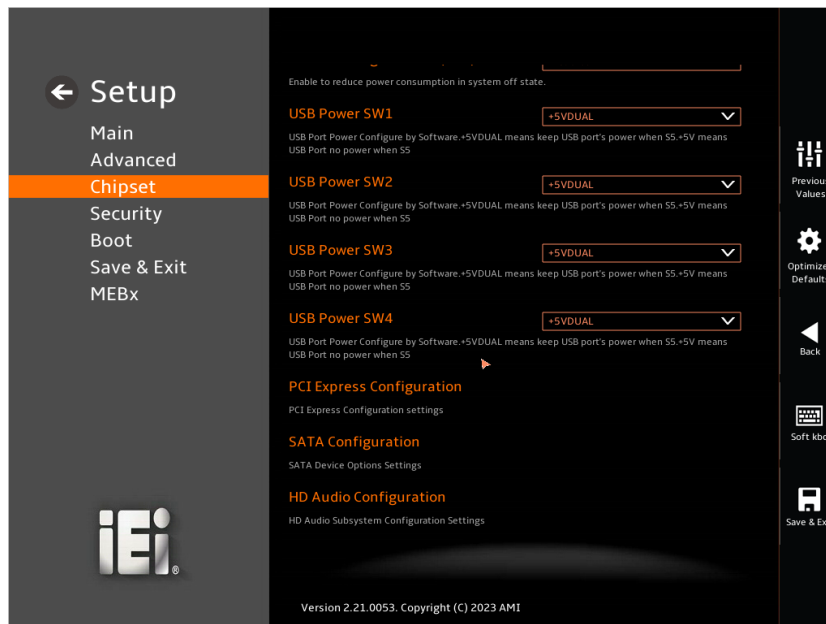

BIOS Menu 35: PCI-IO Configuration (2/2)

→ **Auto Power Button Function [Disabled(ATX)]**

The **Auto Power Button Function** BIOS option to show the power mode state is ATX

→ **Restore AC Power Loss [Last State]**

Use the **Restore AC Power Loss** BIOS option to specify what state the system returns to if there is a sudden loss of power to the system when the power mode is ATX.

- **Power Off** The system remains turned off
- **Power On** The system turns on
- **Last State** **DEFAULT** The system returns to its previous state. If it was on, it turns itself on. If it was off, it remains off.

→ **Power Saving Function (EUP) [Disabled]**

Use the **Power Saving Function (EUP)** BIOS option to enable or disable the power saving function.

- **Disabled** **DEFAULT** Power saving function is disabled.
- **Enabled** Power saving function is enabled. It will reduce power consumption when the system is off.

→ **USB Power SW1 [+5V DUAL]**

Use the **USB Power SW1** BIOS option to configure the USB power source for the corresponding USB connectors (Table 5-1).

- **+5V DUAL** **DEFAULT** Sets the USB power source to +5V dual
- **+5V** Sets the USB power source to +5V

→ **USB Power SW2 [+5V DUAL]**

Use the **USB Power SW2** BIOS option to configure the USB power source for the corresponding USB connectors (Table 5-1).

- **+5V DUAL** **DEFAULT** Sets the USB power source to +5V dual
- **+5V** Sets the USB power source to +5V

DRPC-242-ADL-P**→ USB Power SW3 [+5V DUAL]**

Use the **USB Power SW3** BIOS option to configure the USB power source for the corresponding USB connectors (Table 5-1).

→ +5V DUAL DEFAULT Sets the USB power source to +5V dual

→ +5V Sets the USB power source to +5V

→ USB Power SW4 [+5V DUAL]

Use the **USB Power SW4** BIOS option to configure the USB power source for the corresponding USB connectors (Table 5-1).

BIOS Options	Configured USB Ports
USB Power SW1	LAN1B (external USB 3.2 Gen 2 ports)
USB Power SW2	LAN2B (external USB 2.0 ports)
USB Power SW3	LAN3B (external USB 2.0 ports)
USB Power SW4	USB2_CN1 (internal USB 2.0 pin header)

Table 5-1: BIOS Options and Configured USB Ports

5.4.2.1 PCI Express Configuration

Use the **PCI Express Configuration** submenu (**BIOS Menu 36**) to configure the PCI Express slots.

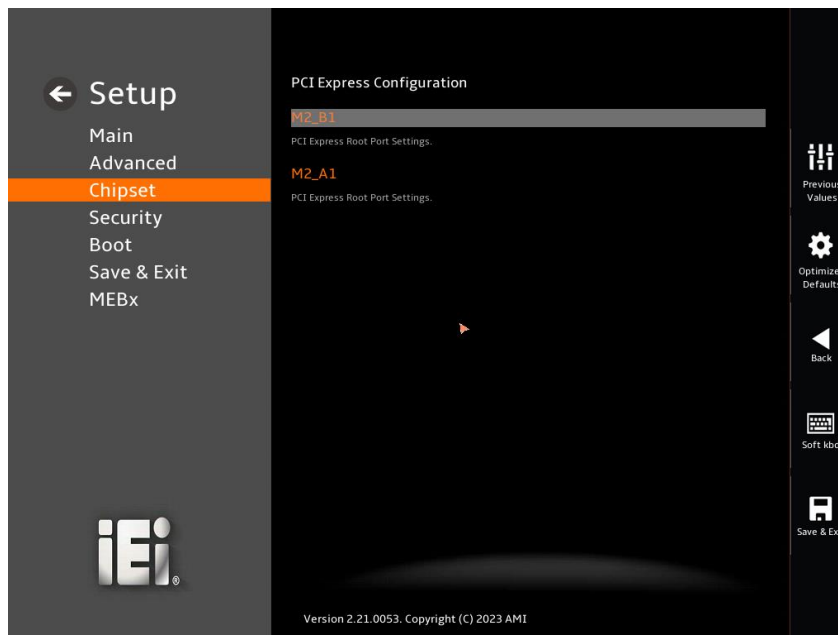

BIOS Menu 36: PCI Express Configuration

5.4.2.1.1 PCI Express Root Port Setting

Use the **M2_B1** and **M2_A1** submenu (**BIOS Menu 37**) to configure the PCI Root Port Settings.



BIOS Menu 37: PCI Express Root Port Settings

→ PCIe Speed [Auto]

Use the **PCIe Speed** option to specify the PCI Express port speed. Configuration options are listed below.

- | | | | |
|---|-------------|----------------|-------------------------------|
| → | Auto | DEFAULT | Auto mode. |
| → | Gen1 | | Configure PCIe Speed to Gen1. |
| → | Gen2 | | Configure PCIe Speed to Gen2. |
| → | Gen3 | | Configure PCIe Speed to Gen3. |

→ Detect Non-Compliance Device [Disabled]

Use the **Detect Non-Compliance Device** option to configure whether to detect if a non-compliance PCI Express device is connected to the PCI Express port.

- | | | | |
|---|-----------------|----------------|--|
| → | Disabled | DEFAULT | Do not detect if a non-compliance PCI Express device is connected to the PCI Express port. |
|---|-----------------|----------------|--|

➔ **Enabled**

Detect if a non-compliance PCI Express device is connected to the PCI Express port.

5.4.2.2 SATA Configuration

Use the **SATA Configuration** menu (**BIOS Menu 38**) to change or set the configuration of the SATA devices installed in the system.

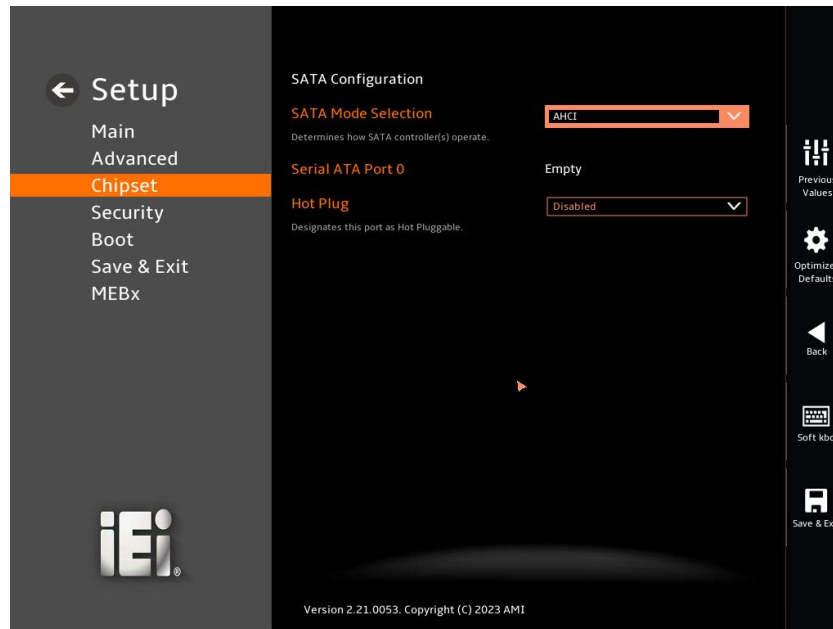

BIOS Menu 38: SATA Configuration

→ SATA Mode Selection [AHCI]

Use the **SATA Mode Selection** option to determine how the SATA devices operate.

→ **AHCI** **DEFAULT** Configures SATA devices as AHCI device.

→ Serial ATA Port 0 [Empty]

→ Hot Plug [Disabled]

Use the **Hot Plug** option to designate the correspondent port as hot-pluggable.

→ **Disabled** **DEFAULT** Disables the hot-pluggable function of the SATA port.

→ **Enabled** Designate the SATA port as hot-pluggable

5.4.2.3 HD Audio Configuration

Use the **HD Audio Configuration** menu (**BIOS Menu 39**) to configure the HD-Audio device settings.

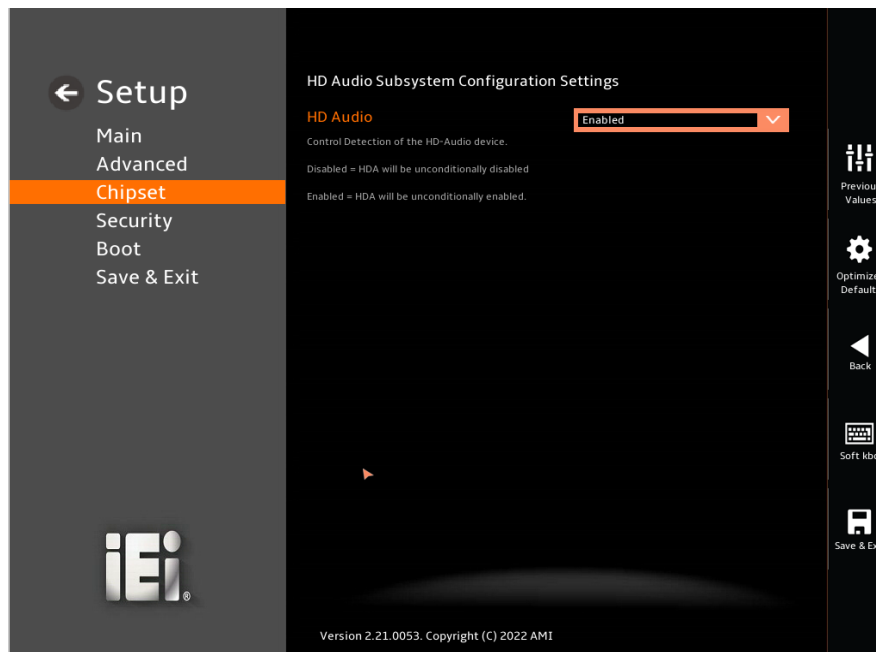

BIOS Menu 39: HD Audio Configuration

→ HD Audio [Enabled]

Use the **HD Audio** option to enable or disable the High Definition Audio controller.

- **Disabled** The onboard High Definition Audio controller is disabled.
- **Enabled** **DEFAULT** The onboard High Definition Audio controller is enabled.

5.5 Security

Use the **Security** menu (**BIOS Menu 40&BIOS Menu 41**) to set system and user passwords.



BIOS Menu 40: Security (1/2)



BIOS Menu 41: Security (2/2)

→ **Administrator Password**

Use the **Administrator Password** to set or change administrator password.

→ **User Password**

Use the **User Password** to set or change a user password.

5.6 Boot

Use the **Boot** menu (**BIOS Menu 42**) to configure system boot options.



BIOS Menu 42: Boot

5.6.1 Boot Configuration

→ Quiet Boot [Enabled]

Use the **Quiet Boot** BIOS option to select the screen display when the system boots.

- **Disabled** Normal POST messages displayed
- **Enabled** **DEFAULT** OEM Logo displayed instead of POST messages

→ Launch PXE OpROM [Disabled]

Use the **Launch PXE OpROM** option to enable or disable boot option for legacy network devices.

- **Disabled** **DEFAULT** Ignore all PXE Option ROMs
- **Enabled** Load PXE Option ROMs.

5.7 Save & Exit

Use the **Save & Exit** menu (**BIOS Menu 43**) to load default BIOS values, optimal failsafe values and to save configuration changes.

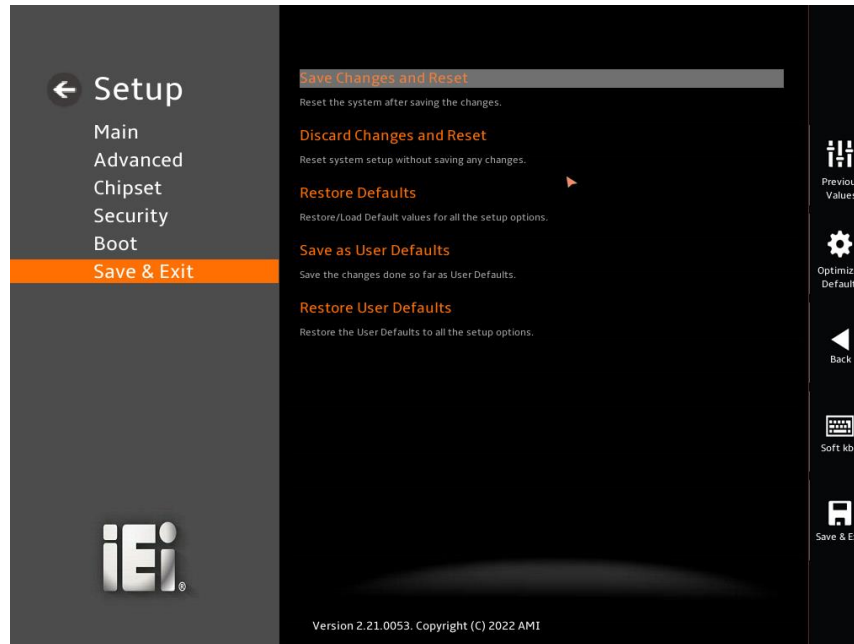

BIOS Menu 43: Save & Exit

→ Save Changes and Reset

Use the **Save Changes and Reset** option to save the changes made to the BIOS options and reset the system.

→ Discard Changes and Reset

Use the **Discard Changes and Reset** option to exit the system without saving the changes made to the BIOS configuration setup program.

→ Restore Defaults

Use the **Restore Defaults** option to load the optimal default values for each of the parameters on the Setup menus. **F3 key can be used for this operation.**

→ Save as User Defaults

Use the **Save as User Defaults** option to save the changes done so far as user defaults.

DRPC-242-ADL-P

→ Restore User Defaults

Use the **Restore User Defaults** option to restore the user defaults to all the setup options.

Appendix

A

Safety Precautions

DRPC-242-ADL-P

A.1 Safety Precautions

**WARNING:**

The precautions outlined in this appendix should be strictly followed. Failure to follow these precautions may result in permanent damage to the DRPC-242-ADL-P Series.

Please follow the safety precautions outlined in the sections that follow:

A.1.1 General Safety Precautions

Please ensure the following safety precautions are adhered to at all times.

- ***Make sure the power is turned off and the power cord is disconnected*** when moving, installing or modifying the system.
- ***Do not apply voltage levels that exceed the specified voltage range.*** Doing so may cause fire and/or an electrical shock.
- ***Electric shocks can occur*** if opened while still powered on.
- ***Do not drop or insert any objects*** into the ventilation openings.
- ***If considerable amounts of dust, water, or fluids enter the system***, turn off the power supply immediately, unplug the power cord, and contact the system vendor.
- ***This equipment is not suitable for use in locations where children are likely to be present.***
- **DO NOT:**
 - Drop the system against a hard surface.
 - In a site where the ambient temperature exceeds the rated temperature

A.1.2 Anti-static Precautions

**WARNING:**

Failure to take ESD precautions during the installation of the DRPC-242-ADL-P Series may result in permanent damage to the DRPC-242-ADL-P Series and severe injury to the user.

Electrostatic discharge (ESD) can cause serious damage to electronic components, including the DRPC-242-ADL-P Series. Dry climates are especially susceptible to ESD. It is therefore critical that whenever the DRPC-242-ADL-P Series is opened and any of the electrical components are handled, the following anti-static precautions are strictly adhered to.

- ***Wear an anti-static wristband:*** Wearing a simple anti-static wristband can help to prevent ESD from damaging any electrical component.
- ***Self-grounding:*** Before handling any electrical component, touch any grounded conducting material. During the time the electrical component is handled, frequently touch any conducting materials that are connected to the ground.
- ***Use an anti-static pad:*** When configuring or working with an electrical component, place it on an anti-static pad. This reduces the possibility of ESD damage.

A.1.3 Product Disposal

**CAUTION:**

Risk of explosion if the battery is replaced by an incorrect type;

Replacement of a battery with an incorrect type that can defeat a safeguard (for example, in the case of some lithium battery types);

Disposal of a battery into fire or a hot oven, or mechanically crushing or cutting of a battery, that can result in an explosion;

Leaving a battery in an extremely high temperature surrounding environment that can result in an explosion or the leakage of flammable liquid or gas;

A battery subjected to extremely low air pressure that may result in an explosion or the leakage of flammable liquid or gas.

Dispose of used batteries according to instructions and local regulations.

- Outside the European Union - If you wish to dispose of used electrical and electronic products outside the European Union, please contact your local authority so as to comply with the correct disposal method.
- Within the European Union:

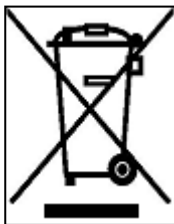

EU-wide legislation, as implemented in each Member State, requires that waste electrical and electronic products carrying the mark (left) must be disposed of separately from normal household waste. This includes monitors and electrical accessories, such as signal cables or power cords.

When you need to dispose of your display products, please follow the guidance of your local authority, or ask the shop where you purchased the product. The mark on electrical and electronic products only applies to the current European Union Member States.

Please follow the national guidelines for electrical and electronic product disposal.

A.2 Maintenance and Cleaning Precautions

When maintaining or cleaning the DRPC-242-ADL-P Series, please follow the guidelines below.

A.2.1 Maintenance and Cleaning

Prior to cleaning any part or component of the DRPC-242-ADL-P Series, please read the details below.

- The interior of the DRPC-242-ADL-P Series does not require cleaning. Keep fluids away from the DRPC-242-ADL-P Series interior.
- Be cautious of all small removable components when vacuuming the DRPC-242-ADL-P Series.
- Turn the DRPC-242-ADL-P Series off before cleaning the DRPC-242-ADL-P Series.
- Never drop any objects or liquids through the openings of the DRPC-242-ADL-P Series.
- Be cautious of any possible allergic reactions to solvents or chemicals used when cleaning the DRPC-242-ADL-P Series.

A.2.2 Cleaning Tools

Some components in the DRPC-242-ADL-P Series may only be cleaned using a product specifically designed for the purpose. In such case, the product will be explicitly mentioned in the cleaning tips. Below is a list of items to use when cleaning the DRPC-242-ADL-P Series.

- **Cloth** – Although paper towels or tissues can be used, a soft, clean piece of cloth is recommended when cleaning the DRPC-242-ADL-P Series.
- **Water or rubbing alcohol** – A cloth moistened with water or rubbing alcohol can be used to clean the DRPC-242-ADL-P Series.
- **Using solvents** – The use of solvents is not recommended when cleaning the DRPC-242-ADL-P Series as they may damage the plastic parts.
- **Vacuum cleaner** – Using a vacuum specifically designed for computers is one of the best methods of cleaning the DRPC-242-ADL-P Series. Dust and

DRPC-242-ADL-P

dirt can restrict the airflow in the DRPC-242-ADL-P Series and cause its circuitry to corrode.

- **Swabs** - Swabs moistened with rubbing alcohol or water are excellent tools for wiping hard to reach areas. Whenever possible, it is best to use lint free swabs such as foam swabs for cleaning.

Appendix

B

Regulatory Compliance

DECLARATION OF CONFORMITY

This equipment is in conformity with the following EU directives:

- EMC Directive 2014/30/EU
- Low-Voltage Directive 2014/35/EU
- RoHS II Directive 2015/863/EU

If the user modifies and/or install other devices in the equipment, the CE conformity declaration may no longer apply.

If this equipment has telecommunications functionality, it also complies with the requirements of the R&TTE Directive 1999/5/EC.

English

IEI Integration Corp declares that this equipment is in compliance with the essential requirements and other relevant provisions of Directive 1999/5/EC.

Български [Bulgarian]

IEI Integration Corp. декларира, че този оборудване е в съответствие със съществените изисквания и другите приложими правила на Директива 1999/5/EC.

Česky [Czech]

IEI Integration Corp tímto prohlašuje, že tento zařizení je ve shodě se základními požadavky a dalšími příslušnými ustanoveními směrnice 1999/5/ES.

Dansk [Danish]

IEI Integration Corp erklærer herved, at følgen e udstyr overholder de væsentlige krav og øvrige relevante krav i direktiv 1999/5/EF.

Deutsch [German]

IEI Integration Corp, erklärt dieses Gerät entspricht den grundlegenden Anforderungen und den weiteren entsprechenden Vorgaben der Richtlinie 1999/5/EU.

Eesti [Estonian]

IEI Integration Corp deklareerib seadme seadme vastavust direktiivi 1999/5/EÜ põhinõuetele ja nimetatud direktiivist tulenevatele teistele asjakohastele sätetele.

Español [Spanish]

IEI Integration Corp declara que el equipo cumple con los requisitos esenciales y cualesquiera otras disposiciones aplicables o exigibles de la Directiva 1999/5/CE.

Ελληνική [Greek]

IEI Integration Corp ΔΗΛΩΝΕΙ ΟΤΙ ΕΞΟΠΛΙΣΜΟΣ ΣΥΜΜΟΡΦΩΝΕΤΑΙ ΠΡΟΣ ΤΙΣ ΟΥΣΙΩΔΕΙΣ ΑΠΑΙΤΗΣΕΙΣ ΚΑΙ ΤΙΣ ΛΟΙΠΕΣ ΣΧΕΤΙΚΕΣ ΔΙΑΤΑΞΕΙΣ ΤΗΣ ΟΔΗΓΙΑΣ 1999/5/ΕΚ.

Français [French]

IEI Integration Corp déclare que l'appareil est conforme aux exigences essentielles et aux autres dispositions pertinentes de la directive 1999/5/CE.

Italiano [Italian]

IEI Integration Corp dichiara che questo apparecchio è conforme ai requisiti essenziali ed alle altre disposizioni pertinenti stabilite dalla direttiva 1999/5/CE.

Latviski [Latvian]

IEI Integration Corp deklarē, ka iekārta atbilst būtiskajām prasībām un citiem ar to saistītajiem noteikumiem Direktīvas 1999/5/ΕΚ.

Lietuvių [Lithuanian]

IEI Integration Corp deklaruoja, kad šis įranga atitinka esminius reikalavimus ir kitas 1999/5/EB Direktyvos nuostatas.

Nederlands [Dutch]

IEI Integration Corp dat het toestel toestel in overeenstemming is met de essentiële eisen en de andere relevante bepalingen van richtlijn 1999/5/EG.

Malti [Maltese]

IEI Integration Corp jiddikjara li dan prodott jikkonforma mal-ħtiġijiet essenzjali u ma provvedimenti oħrajn relevanti li hemm fid-Direttiva 1999/5/EC.

Magyar [Hungarian]

IEI Integration Corp nyilatkozik, hogy a berendezés megfelel a vonatkozó alapvető követelményeknek és az 1999/5/EC irányelv egyéb előírásainak.

Polski [Polish]

IEI Integration Corp oświadcza, że wyrobu jest zgodny z zasadniczymi wymogami oraz pozostałymi stosownymi postanowieniami Dyrektywy 1999/5/EC.

Português [Portuguese]

IEI Integration Corp declara que este equipamento está conforme com os requisitos essenciais e outras disposições da Directiva 1999/5/CE.

Româna [Romanian]

IEI Integration Corp declară că acest echipament este în conformitate cu cerințele esențiale și cu celelalte prevederi relevante ale Directivei 1999/5/CE.

Slovensko [Slovenian]

IEI Integration Corp izjavlja, da je ta opreme v skladu z bistvenimi zahtevami in ostalimi relevantnimi določili direktive 1999/5/ES.

DRPC-242-ADL-P

Slovensky [Slovak]

IEI Integration Corp týmto vyhlasuje, že zariadenia spĺňa základné požiadavky a všetky príslušné ustanovenia Smernice 1999/5/ES.

Suomi [Finnish]

IEI Integration Corp vakuuttaa täten että Iitteet on direktiivin 1999/5/EY oleellisten vaatimusten ja sitä koskevien direktiivin muiden ehtojen mukainen.

Svenska [Swedish]

IEI Integration Corp förklarar att denna utrustningstyp står i överensstämmelse med de väsentliga egenskapskrav och övriga relevanta bestämmelser som framgår av direktiv 1999/5/EG.

ROHS STATEMENT



The label on the product indicates this product conforms to European (EU) Restriction of Hazardous Substances (RoHS) that set maximum concentration limits on hazardous materials used in electrical and electronic equipment.

FCC WARNING

This equipment complies with Part 15 of the FCC Rules. Operation is subject to the following two conditions:

- This device may not cause harmful interference, and
- This device must accept any interference received, including interference that may cause undesired operation.

This equipment has been tested and found to comply with the limits for a Class A digital device, pursuant to part 15 of the FCC Rules. These limits are designed to provide reasonable protection against harmful interference when the equipment is operated in a commercial environment. This equipment generates, uses, and can radiate radio frequency energy and, if not installed and used in accordance with the instruction manual, may cause harmful interference to radio communications. Operation of this equipment in a residential area is likely to cause harmful interference in which case the user will be required to correct the interference at his own expense.

Any changes or modifications not expressly approved by the party responsible for compliance could void the user's authority to operate the equipment.

This equipment complies with FCC radiation exposure limits set forth for an uncontrolled environment. This equipment should be installed and operated with a minimum distance of 20cm between the radiator & your body.

CHINA ROHS

The label on the product indicates the estimated "Environmentally Friendly Use Period" (EFUP). This is an estimate of the number of years that these substances would "not leak out or undergo abrupt change." This product may contain replaceable sub-assemblies/components which have a shorter EFUP such as batteries and lamps. These components will be separately marked.

Appendix

C

BIOS Menu Options

Below is a list of BIOS configuration options in the BIOS chapter.

- ➔ BIOS Information83
- ➔ Processor Information.....83
- ➔ PCH Information.....83
- ➔ System Date [xx:xx:xx].....84
- ➔ System Time [xx:xx:xx]84
- ➔ Efficient-core Information88
- ➔ Performance-core Information88
- ➔ Intel (VXM) Virtualization Technology [Enabled]89
- ➔ Active Performance-cores [All]89
- ➔ Active Efficient-cores [All]89
- ➔ Hyper-Threading [Enabled].....90
- ➔ Intel(R) SpeedStep(tm) [Enabled].....90
- ➔ C states [Disabled].....90
- ➔ Power Limit 1 [0]90
- ➔ Power Limit 2 [0]90
- ➔ Power Limit 1 Time Window [0].....91
- ➔ Turbo Mode [Enabled]91
- ➔ Intel AMT [Enable].....92
- ➔ Unconfigure ME92
- ➔ Security Device Support [Enable]92
- ➔ Pending Operation [None]93
- ➔ Serial Port [Enabled].....95
- ➔ Device Settings95
- ➔ Serial Port [Enabled].....96
- ➔ Device Settings96
- ➔ Serial Port [Enabled].....97
- ➔ Device Settings97
- ➔ Serial Port Mode [RS422]97
- ➔ Serial Port [Enabled].....98
- ➔ Device Settings98
- ➔ Serial Port Mode [RS422]99
- ➔ Serial Port [Enabled].....99
- ➔ Device Settings100

DRPC-242-ADL-P

➔ Serial Port [Enabled].....	100
➔ Device Settings	101
➔ PC Health Status	102
➔ Tcc Activation Offset [0].....	102
➔ CPU_FAN Smart Fan Control [Auto Mode]	104
➔ CPU_FAN Start Temperature [65]	104
➔ CPU_FAN Off Temperature [55]	104
➔ CPU_FAN Start PWM [30].....	104
➔ FAN2 Smart Fan Control [Auto Mode]	104
➔ FAN2 Start Temperature [50]	104
➔ FAN2 Off Temperature [40]	105
➔ FAN2 Start PWM [30]	105
➔ Auto mode fan slope PWM.....	105
➔ Console Redirection [Disabled].....	107
➔ iAMT SOL COM7 (Pci Bus0,Dev0,Func0) [Disabled]	108
➔ Terminal Type [ANSI].....	108
➔ Bits per second [115200].....	109
➔ Data Bits [8]	109
➔ Parity [None].....	109
➔ Stop Bits [1].....	110
➔ VT-d [Enabled].....	113
➔ Primary Display [Auto]	115
➔ Internal Graphics [Enabled].....	115
➔ M2_M1 [Enabled].....	118
➔ PCIe Speed [Auto].....	118
➔ PCIEX4_1 Solt [Enabled]	119
➔ PCIe Speed [Gen3].....	119
➔ Detect Non-Compliance Device [Disabled]	120
➔ Auto Power Button Function [Disabled(ATX)]	122
➔ Restore AC Power Loss [Last State]	122
➔ Power Saving Function (EUP) [Disabled].....	122
➔ USB Power SW1 [+5V DUAL].....	122
➔ USB Power SW2 [+5V DUAL].....	122
➔ USB Power SW3 [+5V DUAL].....	123
➔ USB Power SW4 [+5V DUAL].....	123

→	PCIe Speed [Auto].....	125
→	Detect Non-Compliance Device [Disabled]	125
→	SATA Mode Selection [AHCI].....	127
→	Serial ATA Port 0 [Empty]	127
→	Hot Plug [Disabled]	127
→	HD Audio [Enabled]	128
→	Administrator Password	130
→	User Password	130
→	Quiet Boot [Enabled]	131
→	Launch PXE OpROM [Disabled]	131

Appendix

D

Hazardous Materials Disclosure

D.1 RoHS II Directive (2015/863/EU)

The details provided in this appendix are to ensure that the product is compliant with the RoHS II Directive (2015/863/EU). The table below acknowledges the presences of small quantities of certain substances in the product, and is applicable to RoHS II Directive (2015/863/EU).

Please refer to the following table.

Part Name	Toxic or Hazardous Substances and Elements									
	Lead (Pb)	Mercury (Hg)	Cadmium (Cd)	Hexavalent Chromium (CR(VI))	Polybrominated Biphenyls (PBB)	Polybrominated Diphenyl Ethers (PBDE)	Bis(2-ethylhexyl) phthalate (DEHP)	Butyl benzyl phthalate (BBP)	Dibutyl phthalate (DBP)	Diisobutyl phthalate (DIBP)
Housing	O	O	O	O	O	O	O	O	O	O
Display	O	O	O	O	O	O	O	O	O	O
Printed Circuit Board	O	O	O	O	O	O	O	O	O	O
Metal Fasteners	O	O	O	O	O	O	O	O	O	O
Cable Assembly	O	O	O	O	O	O	O	O	O	O
Fan Assembly	O	O	O	O	O	O	O	O	O	O
Power Supply Assemblies	O	O	O	O	O	O	O	O	O	O
Battery	O	O	O	O	O	O	O	O	O	O

O: This toxic or hazardous substance is contained in all of the homogeneous materials for the part is below the limit requirement in Directive (EU) 2015/863.

X: This toxic or hazardous substance is contained in at least one of the homogeneous materials for this part is above the limit requirement in Directive (EU) 2015/863.

D.2 China RoHS

此附件旨在确保本产品符合中国 RoHS 标准。以下表格标示此产品中某有毒物质的含量符合中国 RoHS 标准规定的限量要求。

本产品上会附有“环境友好使用期限”的标签，此期限是估算这些物质“不会有泄漏或突变”的年限。本产品可能包含有较短的环境友好使用期限的可替换元件，像是电池或灯管，这些元件将会单独标示出来。

部件名称	有毒有害物质或元素					
	铅 (Pb)	汞 (Hg)	镉 (Cd)	六价铬 (CR(VI))	多溴联苯 (PBB)	多溴二苯醚 (PBDE)
壳体	○	○	○	○	○	○
显示	○	○	○	○	○	○
印刷电路板	○	○	○	○	○	○
金属螺帽	○	○	○	○	○	○
电缆组装	○	○	○	○	○	○
风扇组装	○	○	○	○	○	○
电力供应组装	○	○	○	○	○	○
电池	○	○	○	○	○	○
<p>○: 表示该有毒有害物质在该部件所有物质材料中的含量均在 SJ/T11364-2014 與 GB/T26572-2011 标准规定的限量要求以下。</p> <p>X: 表示该有毒有害物质至少在该部件的某一均质材料中的含量超出 SJ/T11364-2014 與 GB/T26572-2011 标准规定的限量要求。</p>						