

PPC2-CW215A-ADLP

IEI Heavy Industrial Panel PC

Powered by Intel® Alder Lake-P/Raptor Lake-P processor



www.ieiworld.com



PPC2-CW215A-ADLP

Fanless, high-performance Panel PC, supporting Intel® 12th/13th Gen Core™ i7/i5/i3 Mobile Processors, 8GB DDR4 SO-DIMM memory, dual 2.5GbE LANs, HDMI 4K output, triple M.2 expansion slots, IPMI remote management, and Anti-glare/UV 10-point capacitive touchscreen.

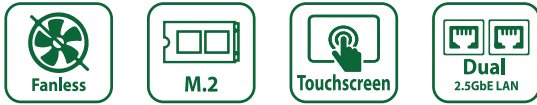

12th/13th Gen Intel® Core™ Mobile Processors

The 12th/13th Generation Intel® Core™ mobile processors feature a new Performance Hybrid Architecture that delivers superior performance and rich scaling for a superior experience.

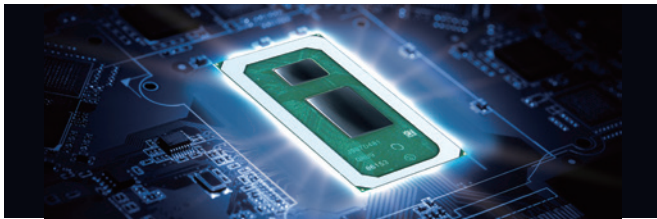

Support 4K UHD Display Output

10th generation Intel® Ultra HD graphics engine allows the system to display video and images in stunning 4K resolution over HDMI 1.4b



Anti-glare and Anti-UV PCAP

With anti-glare and anti-UV coating, the 10-point touchscreen provides clear display without reflections.



Support WiFi 6E and Bluetooth 5.2(optional)

Powerful Wi-Fi 6E and low-latency Bluetooth 5.2 provide wider bandwidth and more stable signals while consuming less power.



IPMI 2.0 Remote Management(optional)

Together with the IEI iRIS expansion card, it can support remote management system over the network for OS installation and restoration, power on or power off, and other operations.

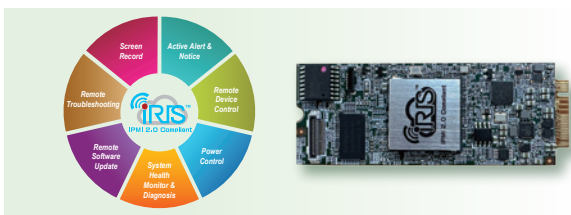

Dual full-speed M.2 expansion slots

Two M.2 M-key slots accept 2280 sizes of M.2 modules, and supports PCIe Gen4 x4 full-speed signal for more bandwidth and faster speed.

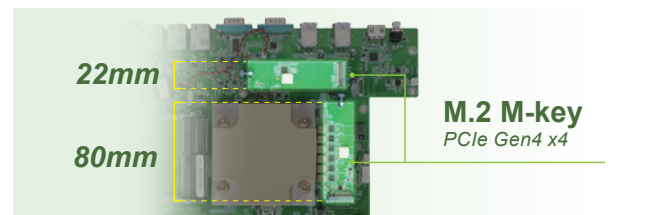

Fully Integrated I/O

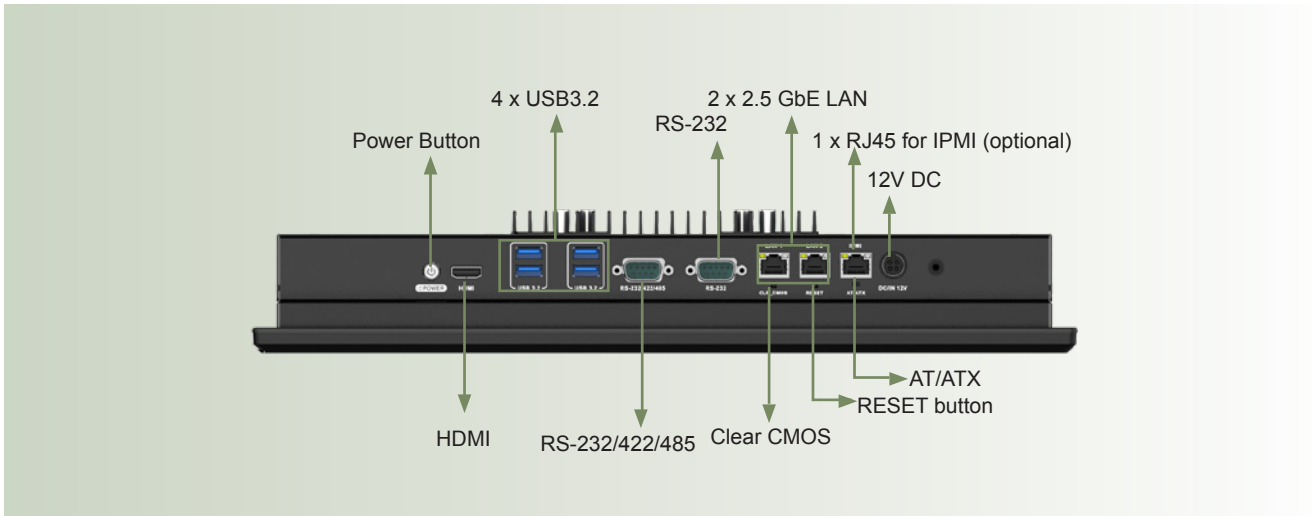

Block Diagram

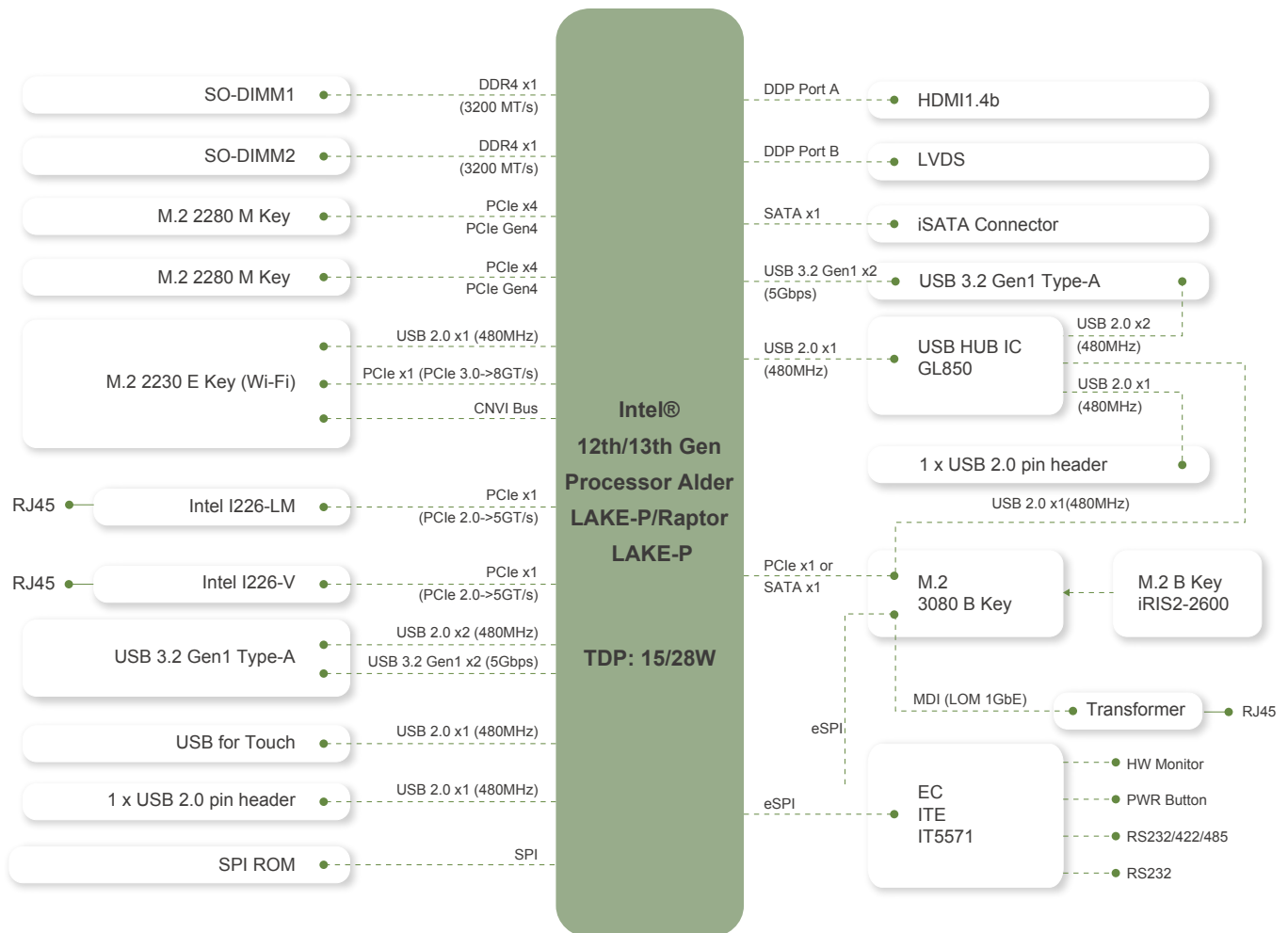

Dimensions (Unit: mm)

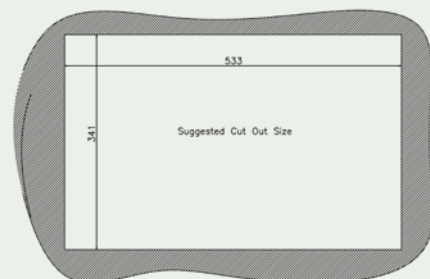
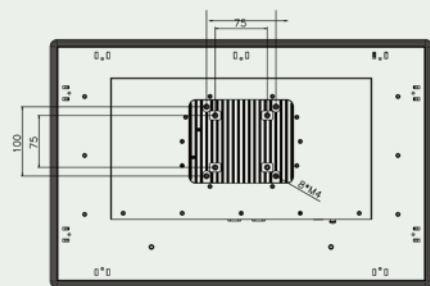
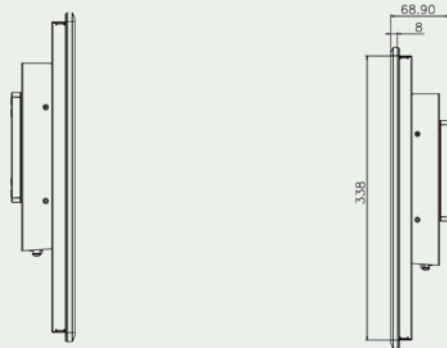
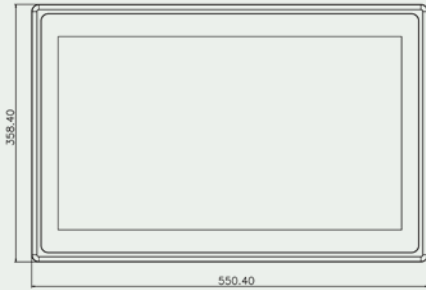
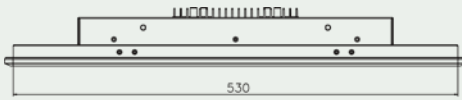

Specifications

Model	PPC2-CW215A-ADLP		
LCD Size	21.5" (16:9)		
Resolution	1920 (W) x 1080 (H)		
Brightness	350 cd/m ²		
Contrast Ratio	1000:1		
LCD Color	16.7M		
Viewing Angle (H-V)	178°/178°		
Backlight MTBF	50000 hours		
CPU (SoC)	12th/13th Generation Intel® Alder Lake-P/ Raptor Lake-P Core™ i7/i5/i3 Processor		
Memory	Dual channel SO-DIMM DDR4-3200 (Max. 64GB) (Pre-installed 1 x 8GB)		
Touchscreen	PCAP with USB interface (Anti-UV/AG coating)		
Touch Controller	EETI EXC 81 Series		
Ethernet	LAN1: Intel® I226 LM(support Intel AMT) ; LAN2: Intel® I226V		
Expansion	2 x M.2 2280 M-key (PCIex4) 1 x M.2 3080 B-key (PCIex1 or SATA) support IPMI function 1 x M.2 2230 E-key (PCIex1 + USB)		
I/O Ports & Switch	1 x RS-232/422/485 w/ AFC by DB9 1 x RS-232 by DB9 1 x RJ45 for IPMI 1 x Power Button	2 x 2.5GbE LAN 1 x HDMI output 1 x Reset Button	1 x AT/ATX Switch 4 x USB 3.2 Gen1 1 x 12V DC Jack 1 x ClearCMOS Button
Mounting	VESA 75/100 ; Panel, Wall, Rack, Stand and Arm		
Construction Material	Aluminum die casting+SECC		
Enclosure Color	Black		
Power Input	12V DC		
Thermal	Fanless		
TPM	Intel® Platform Trust Technology		
watch dog	Software Programmable support 1~255 sec. system reset		
Operating Temperature (°C) (Ambient with air flow)	-20°C ~ 60°C(60@50RH)		
Storage Temperature (°C)	-20°C ~ 70°C(70°C@20%RH)		
Humidity	10 ~ 90RH(40°C@90RH) (non-condensing)		
Operating Vibration	Operation: Random Vibration Mode,MIL-STD-810G 514.6C-1(With SSD) Non-OP:Sine Vibration Mode,IEC-60068-2-06		
Operating Shock	Operation: IEC68-2-27 5 G,11ms,100 shocks Non-OP: IEC68-2-27 15 G,11ms,100 shocks		
IP level	Front panel IP65 compliant		
Safety&EMC	CE/EMC , FCC		
ErP	ErP 2009/125/EC		
Dimensions (H x W x D)	550.40 x 358.40 x 68.90		
Net Weight	7.165 kg		
Power Consumption	+12V @ 6.507A (Intel® Core™ i7-1260P with 8GB memory)		
OS	Microsoft® Windows 10/11 IOT;Linux		

Ordering Information

PPC2-CW215A-ADLP-i3/8G-R11	21.5" 350cd/m ² 1920x1080 Fanless Panel PC with 12th Generation Intel® Core™ i3-1220P on-board Processor,TDP 28W, 8GB DDR4, PCAP touch,12V DC,Ver 1.03,R11
PPC2-CW215A-ADLP-i5/8G-R11	21.5" 350cd/m ² 1920x1080 Fanless Panel PC with 12th Generation Intel®Core™ i5-1240P on-board Processor,TDP 28W, 8GB DDR4, PCAP touch,12V DC,Ver 1.03,R11
PPC2-CW215A-ADLP-i7/8G-R11	21.5" 350cd/m ² 1920x1080 Fanless Panel PC with 12th Generation Intel® Core™ i7-1260P on-board Processor,TDP 28W, 8GB DDR4, PCAP touch,12V DC,Ver 1.03,R11
PPC2-CW215A-ADLP-Ri3E/8G-R11	21.5" 350cd/m ² 1920x1080 Fanless Panel PC with 13th Generation Intel® Core™ i3-1320PE on-board Processor,TDP 28W, 8GB DDR4, PCAP touch,12V DC,Ver 1.03,R11
PPC2-CW215A-ADLP-Ri5E/8G-R11	21.5" 350cd/m ² 1920x1080 Fanless Panel PC with 13th Generation Intel® Core™ i5-1340PE on-board Processor,TDP 28W, 8GB DDR4, PCAP touch,12V DC,Ver 1.03,R11
PPC2-CW215A-ADLP-Ri7E/8G-R11	21.5" 350cd/m ² 1920x1080 Fanless Panel PC with 13th Generation Intel® Core™ i7-1370PE on-board Processor,TDP 28W, 8GB DDR4, PCAP touch,12V DC,Ver 1.03,R11

Packing List

Power Cord*1	Power Adapter*1	QIG*1	Screw*1
--------------	-----------------	-------	---------

Options

Item	Part No.
Wall mounting Kit	AFLWK-19B
Arm	ARM-11-RS
Stand	STAND-A21-R10/ STAND-210-R11/STAND-C19-R10
IPMI card	iRIS2-2600-R10/iRIS2-2620-R10
Wifi Kit	EMB-WIFI-KIT02I3-R10