



®

AXIOMTEK

eBOX620-841-FL Series

Embedded System

User's Manual



Disclaimers

This manual has been carefully checked and believed to contain accurate information. Axiomtek Co., Ltd. assumes no responsibility for any infringements of patents or any third party's rights, or any liability arising from such uses.

Axiomtek does not warrant or assume any legal liability or responsibility for the accuracy, completeness or usefulness of any information in this document. Axiomtek does not make any commitment to update any information in this manual.

Axiomtek reserves the right to change or revise this document and/or product at any time without notice.

No part of this document may be reproduced, stored in a retrieval system, or transmitted in any forms or by any means, electronic, mechanical, photocopying, recording, among others, without prior written permissions of Axiomtek Co., Ltd.

©Copyright 2016 Axiomtek Co., Ltd.

All Rights Reserved

December 2016, Version A3

Printed in Taiwan

Safety Precautions

Before getting started, please read the following important safety precautions.

1. The eBOX620-841-FL does not come with an operating system which must be loaded first before installation of any software into the computer.
2. Be sure to ground yourself to prevent static charge when installing any internal components. Use a wrist grounding strap and place all electronic components in any static-shielded devices. Most electronic components are sensitive to static electrical charge.
3. Disconnect the power cord from the eBOX620-841-FL prior to making any installation. Be sure both the system and all external devices are turned OFF. Sudden surge of power could ruin sensitive components. Make sure the eBOX620-841-FL is properly grounded.
4. Make sure the voltage of the power source is correct before connecting it to any power outlet.
5. Turn Off system power before cleaning. Clean the system using a cloth only. Do not spray any liquid cleaner directly onto the screen.
6. Do not leave equipment in an uncontrolled environment where the storage temperature is below -40°C or above 80°C as it may damage the equipment.
7. Do not open the system's back cover. If opening the cover for maintenance is a must, only a trained technician is allowed to do so. Integrated circuits on computer boards are sensitive to static electricity. To avoid damaging chips from electrostatic discharge, observe the following precautions:
 - Before handling a board or integrated circuit, touch an unpainted portion of the system unit chassis for a few seconds. This will help discharge any static electricity on human body.
 - When handling boards and components, wear a wrist grounding strap available from most electronic component stores.

Classification

1. Degree of protection against electric shock: not classified
2. Degree of protection against ingress of water: IP40
3. Equipment not suitable for use in the presence of a flammable anesthetic mixture with air, oxygen or nitrous oxide.
4. Mode of operation: Continuous

General Cleaning Tips

Please keep the following precautions in mind while understanding the details fully before and during any cleaning of the computer and any components within.

A piece of dry cloth is ideal to clean the device.

1. Be cautious of any tiny removable components when using a vacuum cleaner to absorb dirt on the floor.
2. Turn the system off before clean up the computer or any components within.
3. Avoid dropping any components inside the computer or getting circuit board damp or wet.
4. For cleaning, be cautious of all kinds of cleaning solvents or chemicals which may cause allergy to certain individuals.
5. Keep foods, drinks or cigarettes away from the computer.

Cleaning Tools:

Although many companies have created products to help improve the process of cleaning computer and peripherals, users can also use house hold items accordingly for cleaning. Listed below are items available for cleaning computer or computer peripherals.

Pay special attention to components requiring designated products for cleaning as mentioned below.

- Cloth: A piece of cloth is the best tool to use when rubbing up a component. Although paper towels or tissues can be used on most hardware as well, it is recommended to use a piece of cloth.
- Water or rubbing alcohol: A piece of cloth may be somewhat moistened with water or rubbing alcohol before being rubbed on the computer. Unknown solvents may be harmful to plastic parts.
- Absorb dust, dirt, hair, cigarette and other particles outside of a computer can be one of the best methods of cleaning a computer. Over time these items may restrict the airflow in a computer and cause circuitry to corrode.
- Cotton swabs: Cotton swaps moistened with rubbing alcohol or water are applicable to reach areas in keyboard, mouse and other areas.
- Foam swabs: If possible, it is better to use lint free swabs such as foam swabs.



【Note】 : *It is strongly recommended that customer should shut down the system before start to clean any single components.*

Please follow the steps below:

1. Close all application programs;
2. Close operating software;
3. Turn off power switch;
4. Remove all devices;
5. Pull out power cable.

Scrap Computer Recycling

Please inform the nearest Axiomtek distributor as soon as possible for suitable solutions in case computers require maintenance or repair; or for recycling in case computers are out of order.

Trademarks Acknowledgments

Axiomtek is a trademark of Axiomtek Co., Ltd.

IBM, PC/AT, PS/2, VGA are trademarks of International Business Machines Corporation.

Intel[®] and Pentium[®] are registered trademarks of Intel Corporation.

MS-DOS, Microsoft C and QuickBasic are trademarks of Microsoft Corporation.

Windows 8, Windows 7, Windows XPE, Windows XP, Windows WinCE embedded, Linux,

MS-DOS, Microsoft C and

Other brand names and trademarks are the properties and registered brands of their respective owners.

Table of Contents

Disclaimers.....	ii
Safety Precautions.....	iii
Classification.....	iv
General Cleaning Tips	v
Scrap Computer Recycling.....	vi
CHAPTER 1 INTRODUCTION	1
1.1 General Description.....	1
1.2 System Specifications	2
1.2.1 CPU	2
1.2.2 I/O System	2
1.2.3 System Specification.....	2
1.2.4 Driver CD Content.....	3
1.3 Dimensions	4
1.3.1 System Dimension.....	4
1.3.2 Wall mount Bracket Dimension.....	5
1.4 I/O Outlets	6
1.5 Packing List.....	8
1.6 Model List.....	8
CHAPTER 2 HARDWARE INSTALLATION.....	9
2.1 Installing the Memory module.....	9
2.2 Installing the 2.5" SATA HDD/SSD.....	11
2.3 Installing the CFast Card.....	14
2.4 Installing the Express Mini Card.....	15
2.5 Installing the Wall Mount (Optional).....	16
2.6 Installing the VESA Mount (optional)	18
2.7 Installing the Din-Rail Mount (optional)	20
CHAPTER 3 JUMPER SETTING & CONNECTOR.....	23
3.1 SBC layout.....	23
3.2 Jumper Setting Summary.....	25
3.2.1 Restore BIOS Optimal Defaults (JP4)	25
3.2.2 COM4 Data/Power Selection (JP7)	26
3.2.3 COM3 Data/Power Selection (JP8)	26
3.2.4 Auto power on (JP10).....	26
3.2.5 COM2 Data/Power Selection (JP11).....	27
3.2.6 COM1 Data/Power Selection (JP12).....	27
3.3 Connectors.....	28
3.3.1 AC-DC Jack Power In Connector	29
3.3.2 COM1~COM2 Serial Port Connector	29
3.3.3 COM3~COM4 Serial Port Connector	30
3.3.4 VGA Connector	30
3.3.5 HDMI Connector.....	31
3.3.6 LAN Connector (LAN1, LAN2).....	31

3.3.7	USB Connector	32
3.3.8	ATX Power On/OFF Button	32
3.3.9	Audio Connector	32
3.3.10	Digital I/O Connector	33
3.3.11	SATA Connector	33
3.3.12	SATA Power Connector.....	33
3.3.13	CFast™ slot	34
3.3.14	Half-Size PCI Express Mini card Slot (SCN1).....	35
3.3.15	Full-Size PCI Express Mini Card Slot (SCN2).....	36
3.3.16	SIM Card Slot (SCN3).....	37
CHAPTER 4 BIOS SETUP UTILITY		39
4.1	Starting	39
4.2	Navigation Keys	39
4.3	Main Menu	40
4.4	Advanced Menu.....	41
4.5	Chipset Menu	52
4.6	Boot Menu	55
4.7	Security Menu	56
4.8	Save & Exit Menu	57
APPENDIX A WATCHDOG TIMER.....		59
	About Watchdog Timer	59
	How to Use Watchdog Timer	59
APPENDIX B DIGITAL I/O		61
	About Digital I/O	61
	Digital I/O Programming.....	61

CHAPTER 1

INTRODUCTION

This chapter contains general information and detailed specifications of the eBOX620-841-FL. The Chapter 1 includes the following sections:

- General Description
- System Specification
- Dimensions
- I/O Outlets
- Packing List
- Model List

1.1 General Description

The eBOX620-841-FL is an embedded system that supports onboard quad core Intel® Atom™ E3845 (1.91 GHz) single chip design to provide Windows 8, Windows 7 , Windows 8 Embedded, Windows 7 Embedded or Linux, suitable for the most enduring operation. It features fan less design with full feature I/O, one 204-pin unbuffered SODIMM socket for single channel DDR3L-1066/1333 MHz memory, and enhanced system dependability by built-in Watchdog Timer.

➤ **Features**

1. Intel® E3845 1.91 GHz quad core SoC
2. Maximum to 8GB DDR3L-1066/1333 memory for E3845
3. Ultra slim and compact design
4. VGA & HDMI for display output
5. Supports 4 USB 2.0 ports
6. Supports 2 RS-232/422/485 and 2 RS-232
7. Supports dual 10/100/1000Mbps Ethernet port
8. One 2.5" SATA HDD drive bay
9. One front access CFast™
10. One Full-Size Mini PCI Express Mini Card w/mSATA supported
11. One Half-Size Mini PCI Express Mini Card
12. One 8 channel programmable Digital I/O, default 3In/5Out
13. Watchdog timer
14. 60W AC-DC Adapter
15. Wide temperature: -40°C~60°C supported (with W.T. SSD & Memory)

➤ **Reliable and Stable Design**

The eBOX620-841-FL adopts the advanced cooling system and supporting the CFast™, which makes it especially suitable for vibration environments, best for industrial automation, digital signage and gaming application.

➤ **Embedded O.S. Supported**

The eBOX620-841-FL not only supports Windows 8, Windows 7, but also supports embedded OS, such as Windows 8 Embedded, Windows 7 Embedded, WinCE and Linux .

➤ **Various Storage devices supported**

For storage device, the eBOX620-841-FL supports one 2.5" SATA storage drive bay, one CFast™ slot and mSATA.

1.2 System Specifications

1.2.1 CPU

- **CPU**
 - Intel® Atom™ quad core E3845 1.91GHz.
- **BIOS**
 - American Megatrends Inc. UEFI (Unified Extensible Firmware Interface) BIOS.
 - 16Mbit SPI Flash, DMI, Plug and Play.
 - PXE Ethernet Boot ROM.
- **System Memory**
 - One 204-pin unbuffered DDR3L SO-DIMM socket.
 - Maximum to 8GB DDR3L 1066/1333 MHz memory for E3845.

1.2.2 I/O System

- Four 9-pin D-Sub male connectors, COM1~COM2 for RS-232/422/485, COM3~COM4 for RS-232
- One 15-pin D-Sub female connector for VGA, up to 1600 x 1200 @60Hz
- One HDMI port, up to 1080P
- Two Audio connector (Mic-IN, Line-OUT), HD audio compliant with Realtek ALC662
- Two RJ-45 connector for 10/100/1000Base-T Ethernet (Intel® i210IT) w/Wake-on-LAN and RPL/PXE Boot ROM
- 8 channel programmable Digital I/O
- Four USB 2.0 connectors
- One 12 VDC Jack for power input connector
- Two Indicators (System Power, HDD Active)

1.2.3 System Specification

- **Watchdog Timer**
 - 1~255 seconds or minutes; up to 255 levels.
- **Power Supply**
 - External 12V@5A, 60W AC/DC power adapter
- **Operation Temperature**
 - -40°C ~ 60°C (-4 °F ~ 140°F), E3845 with W.T. SSD
- **Storage Temperature**
 - -40°C ~ 80°C (-40 °F ~ 176°F)
- **Humidity**
 - 10% ~ 90% (non-condensation)
- **Vibration Endurance**
 - 3Grms w/ CFast™ (5-500Hz, X, Y, Z directions)
- **Weight**
 - 2 kg (4.41 lb) without package/ 2.7 kg (5.95 lb) with package
- **Dimensions**
 - 200mm (7.87") (W) x 120mm (4.72") (D) x 56mm (2.2") (H)

1.2.4 Driver CD Content

- **Driver**
 - Audio
 - Chipset
 - Ethernet
 - Graphic
 - TPM
- **Manual**
 - User Manual
 - Quick Manual



NOTE: All specifications and images are subject to change without notice.

1.3 Dimensions

The following diagrams show you dimensions and outlines of the eBOX620-841-FL.

1.3.1 System Dimension

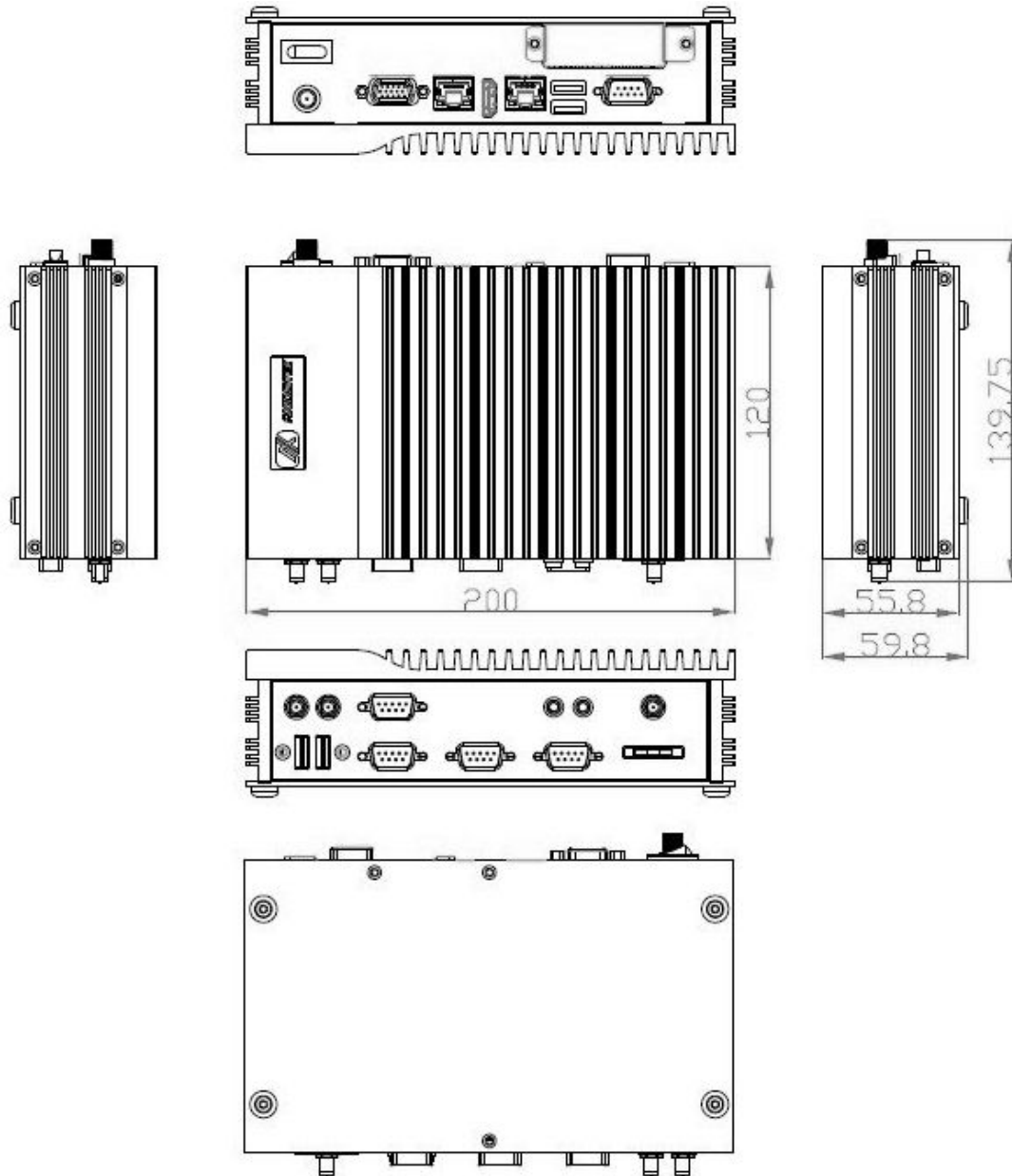

1.3.2 Wall mount Bracket Dimension

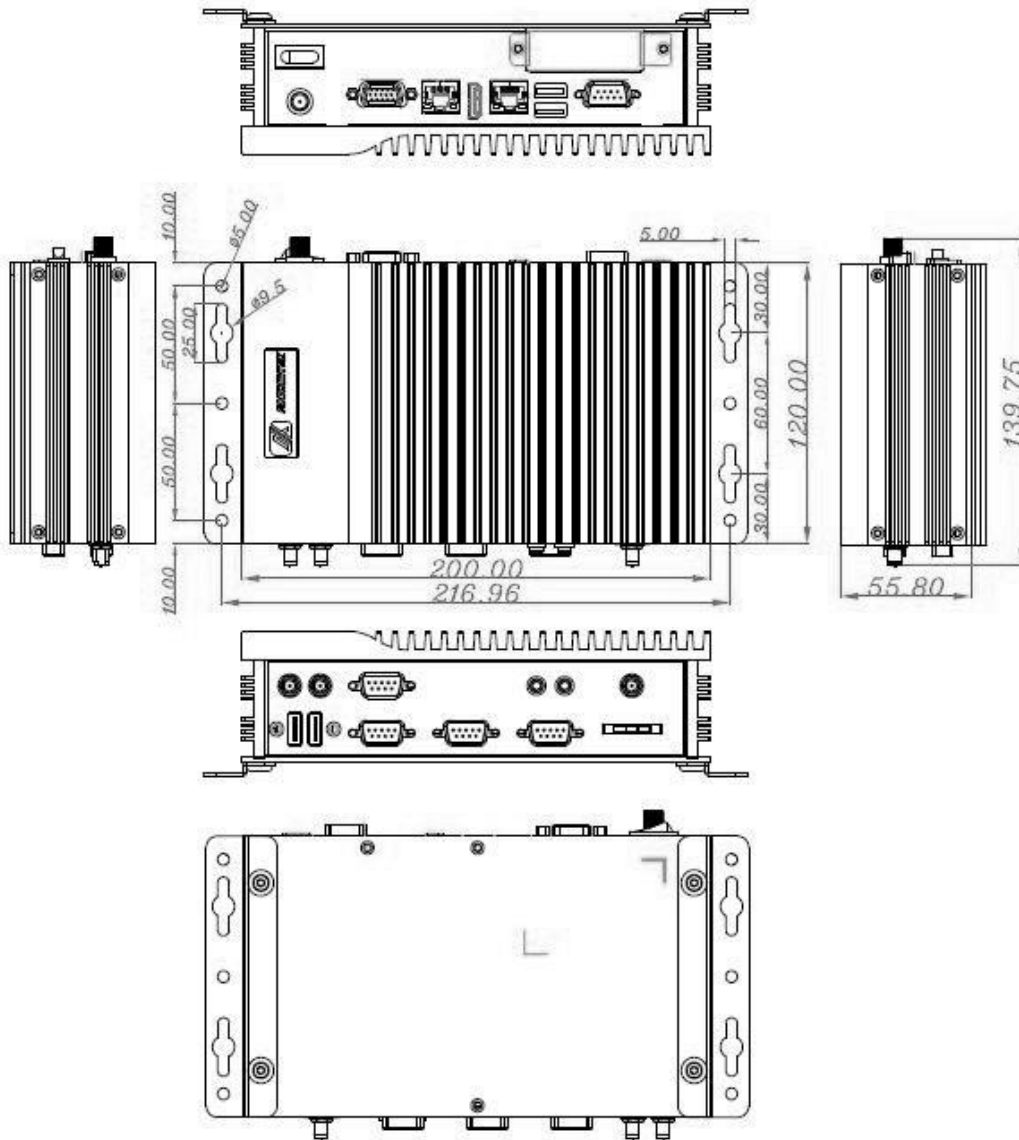

1.4 I/O Outlets

The following figures show you I/O outlets on front view of the eBOX620-841-FL.

- Front View



- Front View drawing

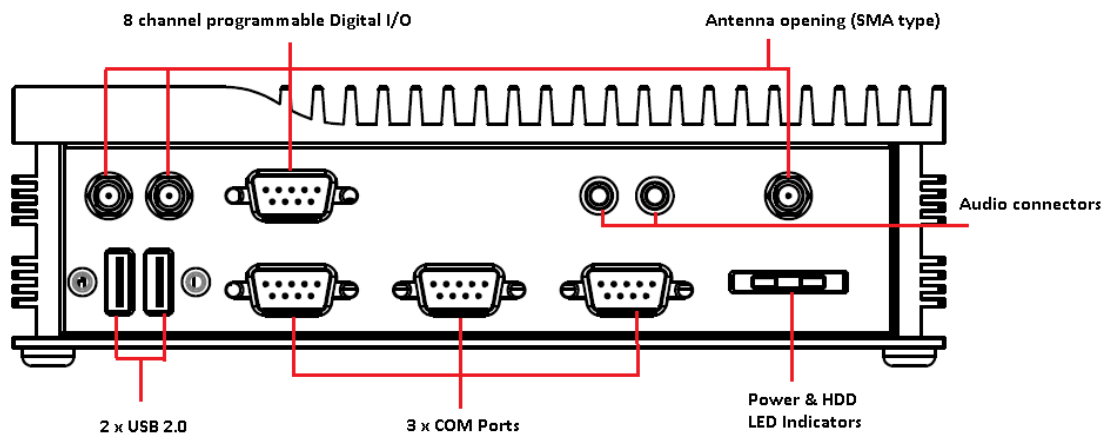

- **Rear View**



- **Rear View drawing**

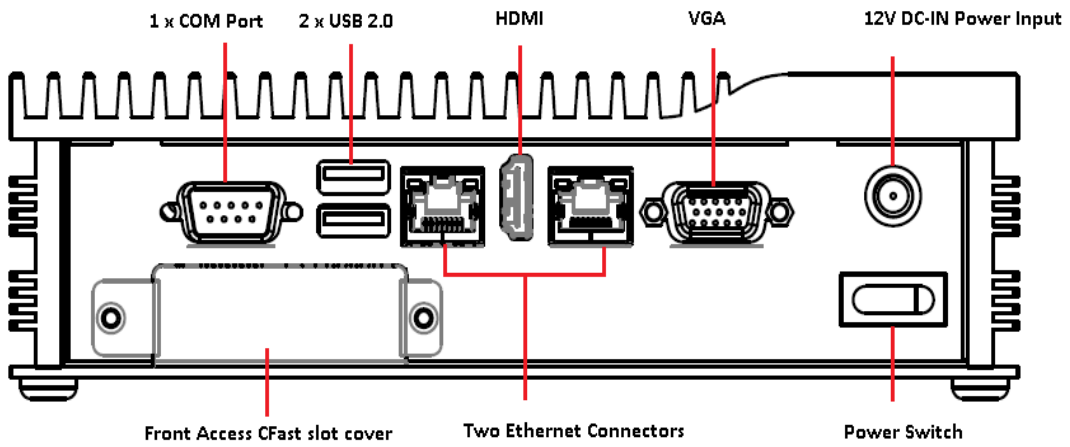

1.5 Packing List

The package bundled with your eBOX620-841-FL should contain the following items:

- eBOX620-841-FL System Unit x 1
- eBOX620-841-FL Quick Manual x 1
- CD x 1 (For Driver and User's Manual)
- Screws pack x 1
- Foot pad x 4
- Thermal Grease x 1
- CFast™ card Handhold Mylar x 1
- 60W AC-DC Adapter
- Wall-mount Brackets (optional)
- VESA-mount Bracket (optional)
- Din-rail Bracket (optional)
- 2.5" SATA Storage (optional)
- CFast™ / mSATA card (optional)
- DDR3 SODIMM (optional)

If you cannot find this package or any items are missing, please contact Axiomtek distributors immediately.

1.6 Model List

eBOX620-841-FL-E3845-1.91G-US	Fanless embedded system with Intel® ATOM® E3845 1.91GHz quad core single chip design, US power cord
eBOX620-841-FL-E3845-1.91G -EU	Fanless embedded system with Intel® ATOM® E3845 1.91GHz quad core single chip design, EU power cord

CHAPTER 2 HARDWARE INSTALLATION

The eBOX620-841-FL is convenient for your various hardware configurations, such as Memory Module, HDD (Hard Disk Drive), SSD (Solid State Drive) , mSATA and CFast™ card. The chapter 2 will show you how to install the hardware.

2.1 Installing the Memory module

Step 1 Turn off the system, and unplug the power cord.

Step 2 Turn the system upside down to locate screws at the bottom, loosen screws.



Step 3 Remove the bottom cover and Loosen screws of HDD bracket.

Step 4 Remove the HDD bracket.

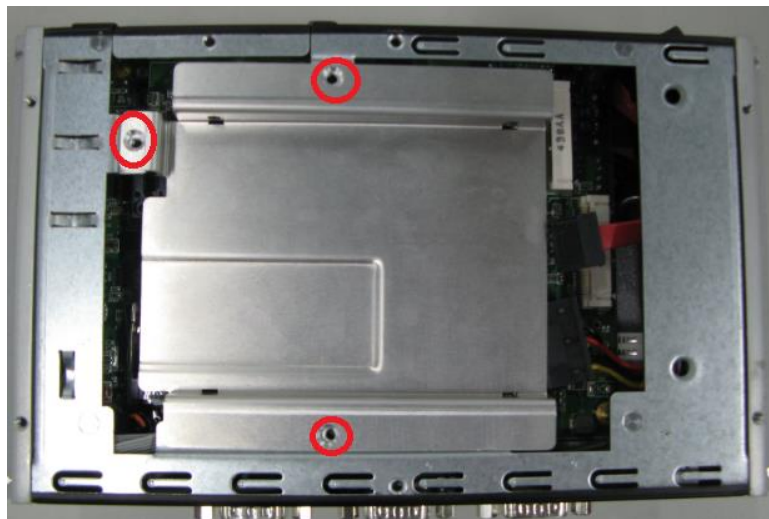

Step 5 Locate the memory module, insert the gold colored contact into the socket.



Step 6 Push the module down, until it is firmly seated by locking two latches on the sides.



Step 7 Fasten screws of HDD bracket.

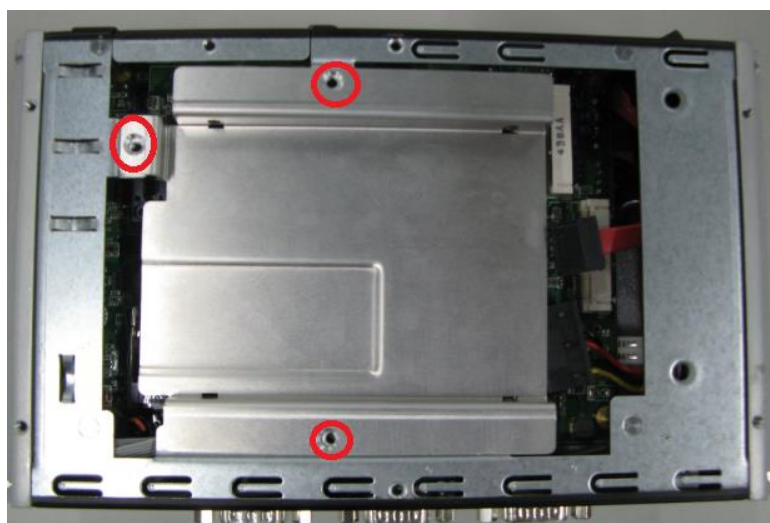

Step 8 Close the cover to the chassis, and fasten all screws.



2.2 Installing the 2.5" SATA HDD/SSD

Step 1 Turn off the system, and unplug the power cord.

Step 2 Turn the system upside down to locate screws at the bottom, loosen screws.



Step 3 Remove the bottom cover and Loosen screws of HDD bracket.

Step 4 Remove the HDD bracket.

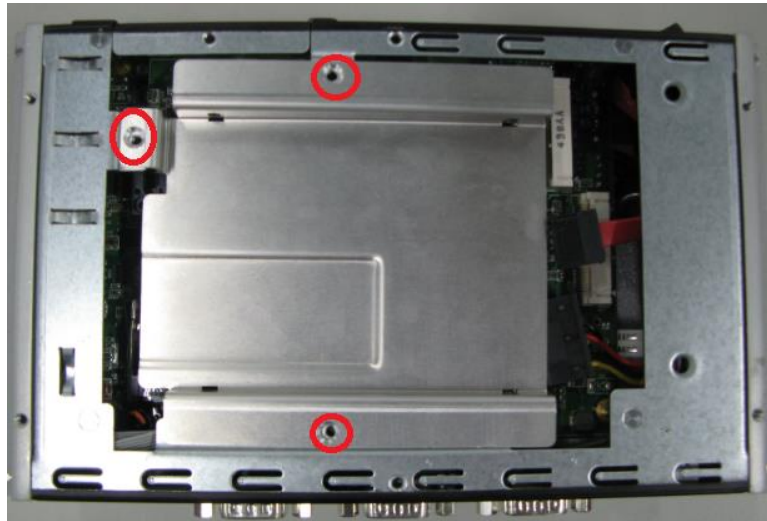

Step 5 Assembly the HDD bracket together with the SATA HDD.

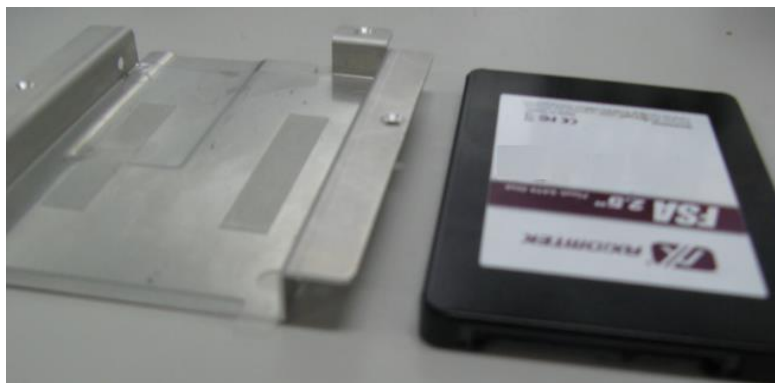

Step 6 Fasten total four screws.



Step 7 Connect SATA cable and power cable to SATA HDD.



Step 8 Fasten screws of HDD bracket.

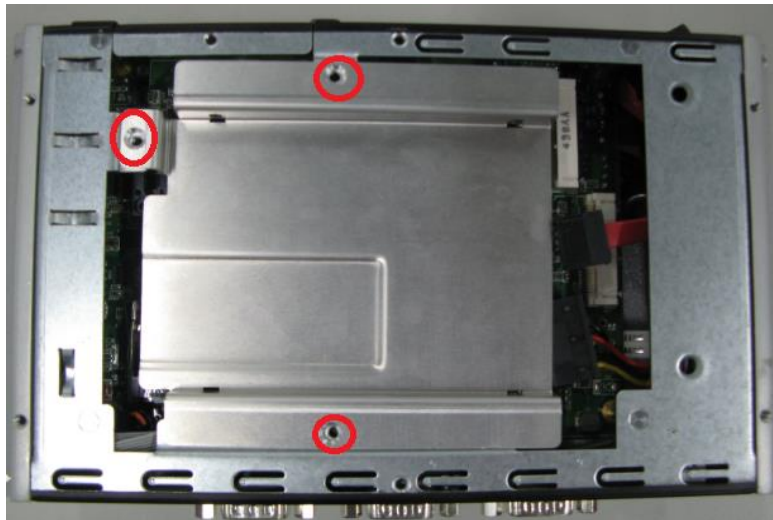

Step 9 Close the cover to the chassis and fasten all screws to finish installation.

2.3 Installing the CFast Card

Step 1 Turn off the system, and unplug the power cord.

Step 2 Turn the system upside down to locate screws at the Bottom, loosen screws.

Step 3 Loosen screws to remove the CFast cover.

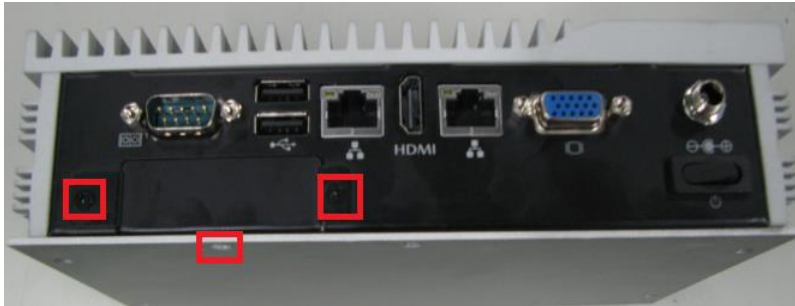

Step 4 Stick the Mylar onto the CFast™ card



Step 5 Slide CFast card into CFast slot with caution.

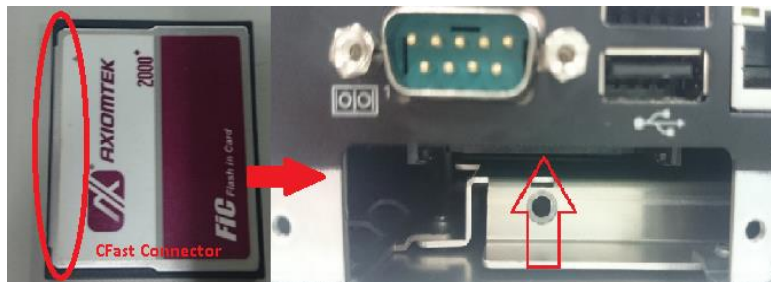

Step 6 Bend the CFast Mylar with caution.

Step 7 Close the cover to the chassis, and fasten all screws.

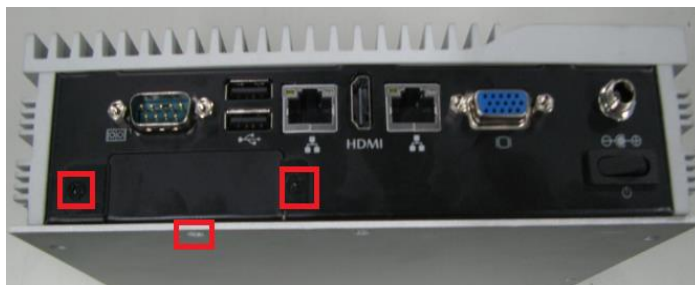

2.4 Installing the Express Mini Card

Step 1 Turn off the system, and unplug the power cord.

Step 2 Turn the system upside down to locate screws at the Bottom, loosen screws.



Step 3 Find the location of Mini card slot.

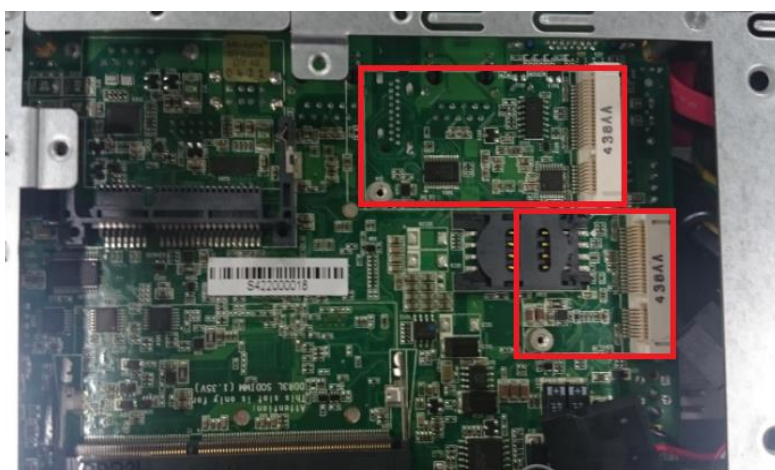

※Please notice that eBOX620-841 supports one full-size Express Mini card slot and one half-size Express Mini card slot.

Step 4 Slide Mini card into Mini Card slot with caution and Fasten screw of Express Mini Card.



Step 5 Assembly the Top Cover back and fasten all screws to finish installation.

2.5 Installing the Wall Mount (Optional)

The eBOX620-841-FL provides Wall Mount that customers can install as below:

Step 1 Prepare Wall Mount assembling components (screws and Bracket) ready.



Step 2 Loosen the screw of four footpads at the bottom of eBOX620-841-FL and remove footpad.



Step 3 Fix the wall mount to the correct location, and fasten all screws.

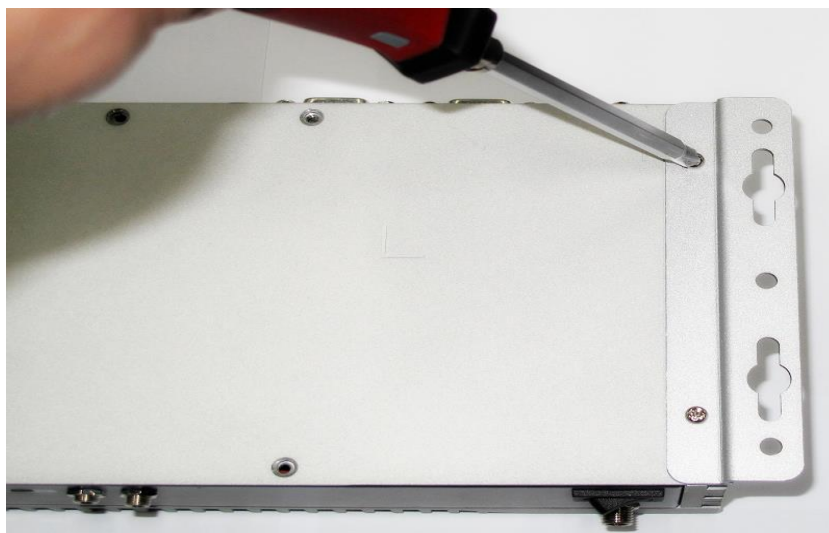

2.6 Installing the VESA Mount (optional)

The eBOX620-841-FL provides VESA Mount that customers can install as below:

Step 1 Prepare VESA Mount assembling components (screws and VESA mount bracket) ready.



Step 2 Loose the screw of four footpads at the bottom of eBOX620-841-FL, and remove footpad.



Step 3 Decide correct mounting direction. eBOX620-841-FL supports both 100x100mm and 75x75mm VESA mount. The 100x100mm type has special direction.

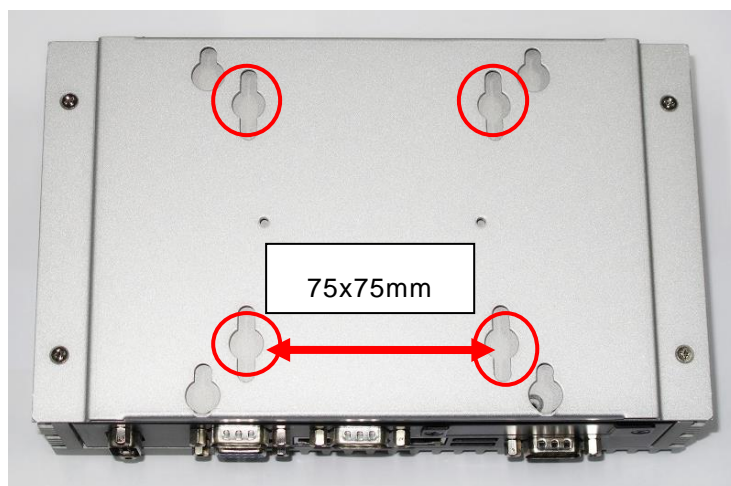
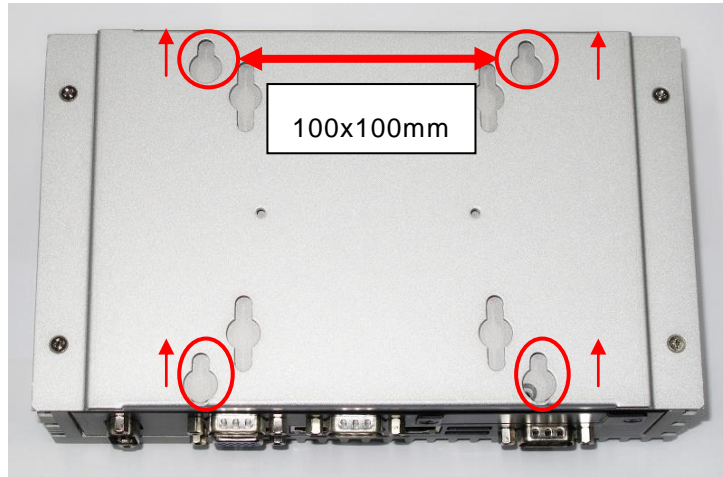

Step 4 Fix the VESA mount to the correct location, and fasten all screws.

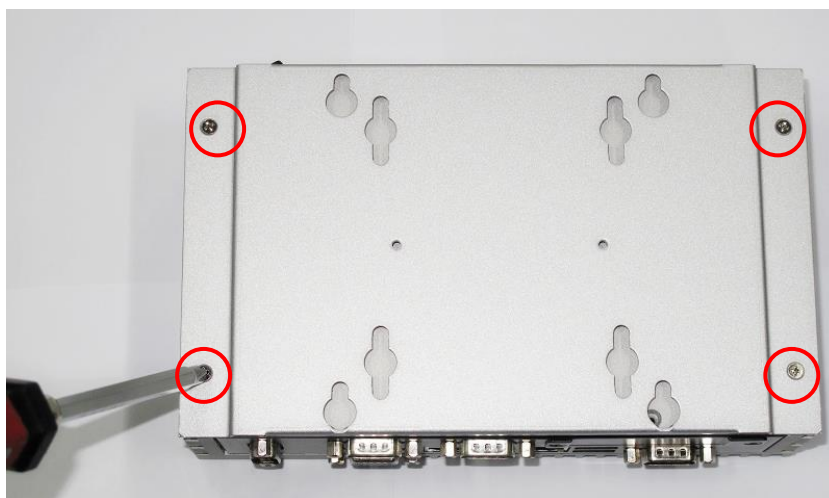

2.7 Installing the Din-Rail Mount (optional)

The eBOX620-841-FL provides Din-Rail Mount that customers can install as below:

Step 1 Prepare Din-Rail Mount assembling components (screws, Din-rail and VESA mount bracket) ready.



Step 2 Loosen the screw of four footpads at the bottom of eBOX620-841-FL and remove footpad.



Step 3 Fix the VESA mount to the correct location, and fasten all screws.

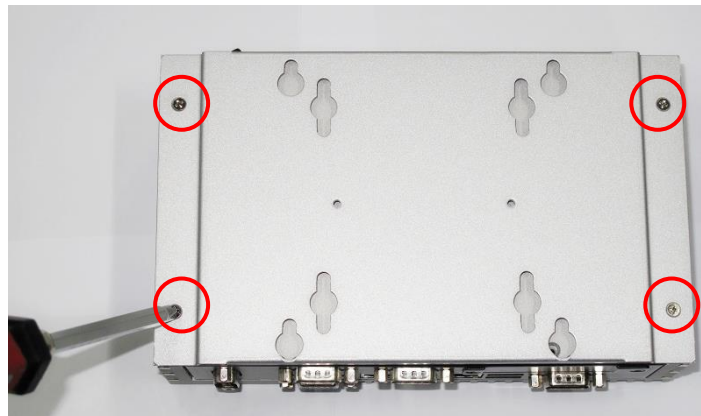

Step 4 Fix the Din-rail mount bracket to the correct location, and fasten all screws.

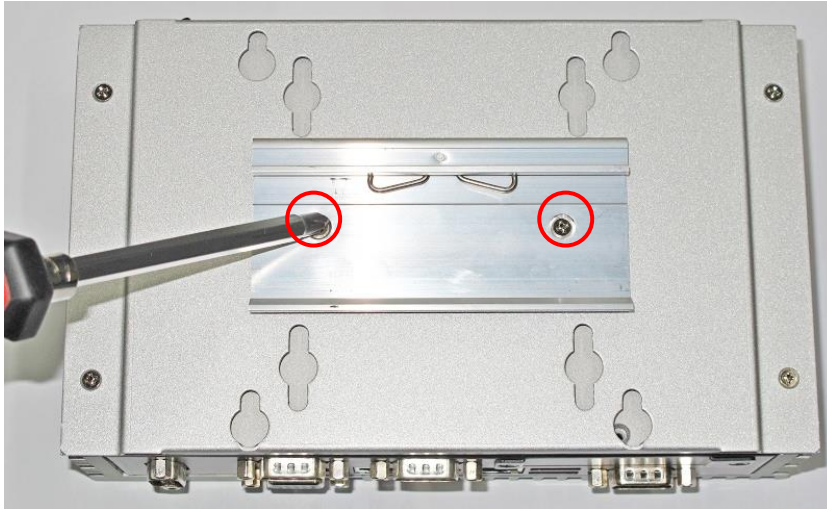

This page is intentionally left blank.

CHAPTER 3 JUMPER SETTING & CONNECTOR

Proper jumper settings configure the eBOX620-841-FL to meet your application purpose. We are herewith listing a summary table of all jumpers and default settings for onboard devices, respectively.

3.1 SBC layout

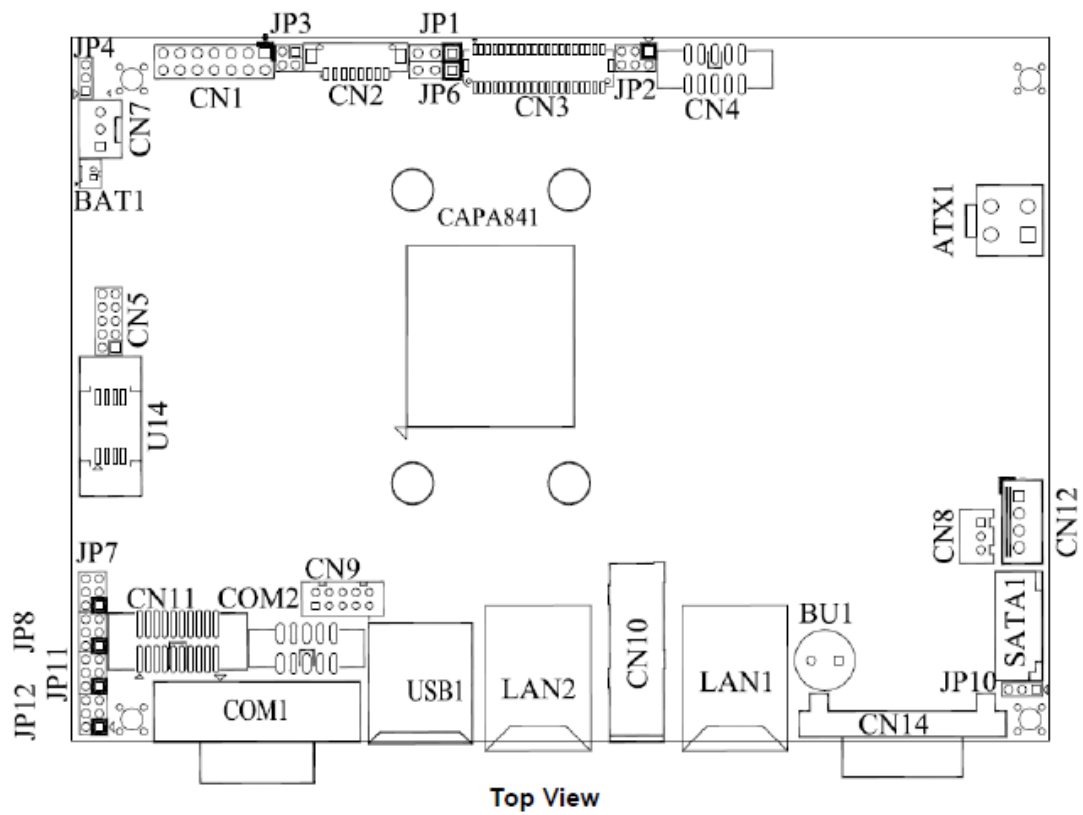

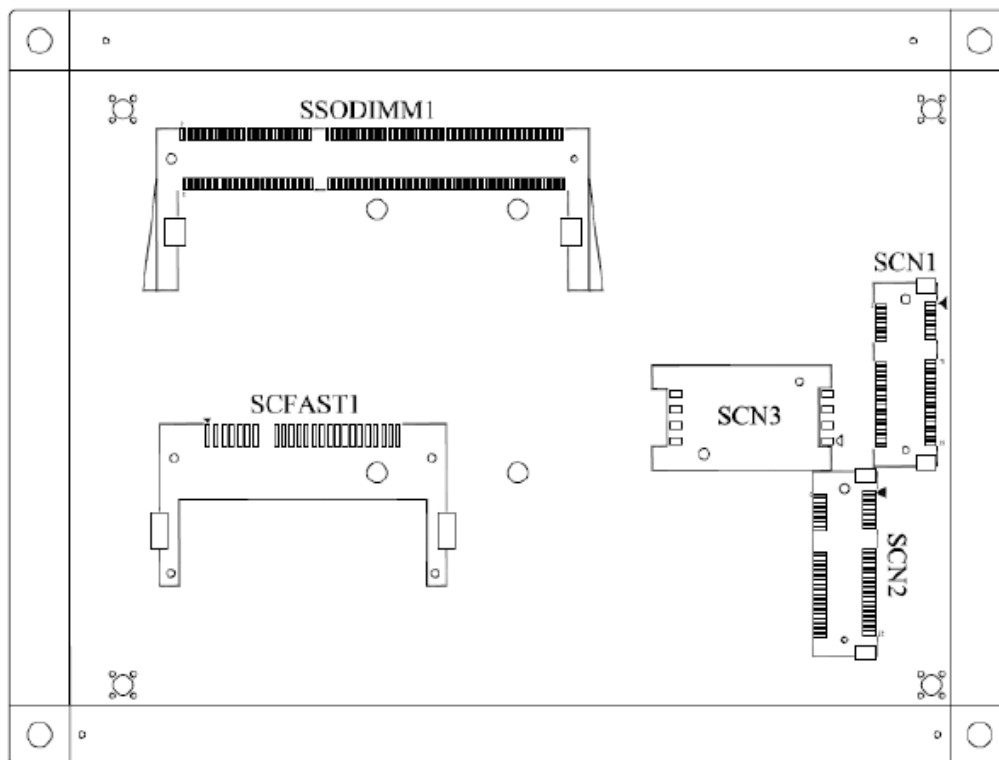

Bottom View



NOTE: We strongly recommended that you should not modify any unmentioned jumper setting without Axiomtek FAE's instruction. Any modification without instruction might cause system to become damage.

3.2 Jumper Setting Summary

Proper jumper settings configure the eBOX620-84-FL to meet your application purpose. We are herewith listing a summary table of all jumpers and default settings for onboard devices, respectively.

Jumper	Description	Jumper Setting
JP4	Restore BIOS Optimal Defaults Default: Normal Operation	1-2 Close
JP7	COM4 Data/Power Selection Default: RS-232 Data	CN11 Pin 11: DCD 3-5 Close
		CN11 Pin 18: RI 4-6 Close
JP8	COM3 Data/Power Selection Default: RS-232 Data	CN11 Pin 1: DCD 3-5 Close
		CN11 Pin 8: RI 4-6 Close
JP10	Auto Power On Default: Disable	1-2 Close
JP11	COM2 Data/Power Selection Default: RS-232 Data	COM2 Pin 1: DCD 3-5 Close
		COM2 Pin 8: RI 4-6 Close
JP12	COM1 Data/Power Selection Default: RS-232 Data	COM1 Pin 1: DCD 3-5 Close
		COM1 Pin 9: RI 4-6 Close



NOTE: How to setup Jumpers

The illustration shows how to set up jumpers. When the jumper cap is placed on pins, the jumper is "close", if not, that means the jumper is "open".



[Open]



[Closed]



[Pin1-2 Closed]

3.2.1 Restore BIOS Optimal Defaults (JP4)

Put jumper clip to pin 2-3 for a few seconds then move it back to pin 1-2. Doing this procedure can restore BIOS optimal defaults.

Function	Setting
Normal (Default)	1-2 close
Restore BIOS optimal defaults	2-3 close



3.2.2 COM4 Data/Power Selection (JP7)

The COM4 port has +5V level power capability on DCD and +12V level on RI by setting this jumper.

Function	Setting
Power: Set CN11 pin 11 to +5V level	1-3 close
Data: Set CN11 pin 11 to DCD (Default)	3-5 close
Power: Set CN11 pin 18 to +12V level	2-4 close
Data: Set CN11 pin 18 to RI (Default)	4-6 close

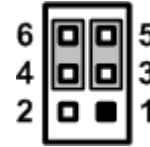

3.2.3 COM3 Data/Power Selection (JP8)

The COM3 port has +5V level power capability on DCD and +12V level on RI by setting this jumper.

Function	Setting
Power: Set CN11 pin 1 to +5V level	1-3 close
Data: Set CN11 pin 1 to DCD (Default)	3-5 close
Power: Set CN11 pin 8 to +12V level	2-4 close
Data: Set CN11 pin 8 to RI (Default)	4-6 close

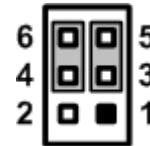

3.2.4 Auto power on (JP10)

If JP10 is enabled for AC power input, the system will be automatically power on without pressing soft power button. If JP10 is disabled for AC power input, it is necessary to manually press soft power button to power on the system.

Function	Setting
Disable auto power on (Default)	1-2 close
Enable auto power on	2-3 close



NOTE: This function is similar to the feature of power on after power failure, which is controlled by hardware circuitry instead of BIOS.

3.2.5 COM2 Data/Power Selection (JP11)

The COM2 port has +5V level power capability on DCD and +12V level on RI by setting this jumper. When this port is set to +5V or +12V level, please make sure its communication mode is RS-232. You can change the communication mode (RS-232/422/485) via BIOS setting.

Function	Setting
Power: Set COM2 pin 1 to +5V level	1-3 close
Data: Set COM2 pin 1 to DCD (Default)	3-5 close
Power: Set COM2 pin 8 to +12V level	2-4 close
Data: Set COM2 pin 8 to RI (Default)	4-6 close

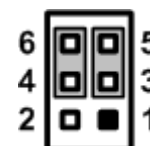

3.2.6 COM1 Data/Power Selection (JP12)

The COM1 port has +5V level power capability on DCD and +12V level on RI by setting this jumper. When this port is set to +5V or +12V level, please make sure its communication mode is RS-232. You can change the communication mode (RS-232/422/485) via BIOS setting.

Function	Setting
Power: Set COM1 pin 1 to +5V level	1-3 close
Data: Set COM1 pin 1 to DCD (Default)	3-5 close
Power: Set COM1 pin 9 to +12V level	2-4 close
Data: Set COM1 pin 9 to RI (Default)	4-6 close



3.3 Connectors

Connectors connect the board with other parts of the system. Loose or improper connection might cause problems. Make sure all connectors are properly and firmly connected. Here is a summary table shows you all connectors and button on the eBOX620-841-FL Series.

External Connectors	Section
AC-DC Jack Power In Connector	3.3.1
COM1~COM2 Serial Port Connector	3.3.2
COM3~COM4 Serial Port Connector	3.3.3
VGA Connector	3.3.4
HDMI Connector	3.3.5
Ethernet Connector(LAN1,LAN2)	3.3.6
USB Connector	3.3.7
ATX Power On/Off Button	3.3.8
Audio Connector	3.3.9
Digital I/O Connector	3.3.10
Internal Connectors	Section
Serial ATA (SATA) Connector	3.3.11
SATA Power Connector	3.3.12
CFast™ Socket	3.3.13
Haif-Size Express Mini Card slot	3.3.14
Full-Size Express Mini Card slot	3.3.15
SIM Card Slot	3.3.16

3.3.1 AC-DC Jack Power In Connector

The system supports a DC12V DC-in Jack connector for system power input. Connect it to the power AC-DC 60W Adapter

Pin	Signal
1	+12V
2	GND



3.3.2 COM1~COM2 Serial Port Connector

The system has four serial ports. COM1~COM2 are RS-232/422/485 ports. Please refer to Chapter 3.2.5 and 3.2.6 for the setting.

Pin	RS-232	RS-485	RS-422
1	DCD, Data Carrier Detect	TX- / RX-	TX-
2	RXD, Receive Data	TX+ / RX+	TX+
3	TXD, Transmit Data	No use	RX+
4	DTR, Data Terminal Ready	No use	RX-
5	GND, Ground	GND	GND
6	DSR, Data Set Ready	No use	No use
7	RTS, Request To Send	No use	No use
8	CTS, Clear To Send	No use	No use
9	RI, Ring Indicator	No use	No use
Pin	RS-232	RS-485	RS-422
1	DCD, Data Carrier Detect	TX- / RX-	TX-
2	RXD, Receive Data	TX+ / RX+	TX+
3	TXD, Transmit Data	No use	RX+
4	DTR, Data Terminal Ready	No use	RX-
5	GND, Ground	GND	GND
6	DSR, Data Set Ready	No use	No use
7	RTS, Request To Send	No use	No use
8	CTS, Clear To Send	No use	No use
9	RI, Ring Indicator	No use	No use

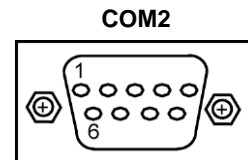
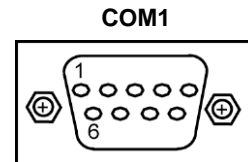

3.3.3 COM3~COM4 Serial Port Connector

The system has four serial ports. COM3~COM4 are RS-232 ports.

Pin	Description
1	DCD, Data Carrier Detect
2	RXD, Receive Data
3	TXD, Transmit Data
4	DTR, Data Terminal Ready
5	GND, Ground
6	DSR, Data Set Ready
7	RTS, Request To Send
8	CTS, Clear To Send
9	RI, Ring Indicator

Pin	Description
1	DCD, Data Carrier Detect
2	RXD, Receive Data
3	TXD, Transmit Data
4	DTR, Data Terminal Ready
5	GND, Ground
6	DSR, Data Set Ready
7	RTS, Request To Send
8	CTS, Clear To Send
9	RI, Ring Indicator

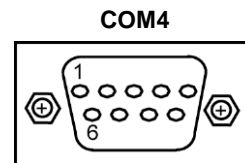
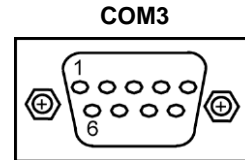

3.3.4 VGA Connector

The VGA connector is a slim type 15-pin D-Sub connector which is common for the CRT VGA display. The VGA interface configuration can be configured via the software utility.

Pin	Signal	Pin	Signal	Pin	Signal
1	Red	2	Green	3	Blue
4	N.C.	5	GND	6	DETECT
7	GND	8	GND	9	VCC
10	GND	11	N.C.	12	DDC DATA
13	Horizontal Sync	14	Vertical Sync	15	DDC CLK



3.3.5 HDMI Connector

The HDMI (High-Definition Multimedia Interface) is a compact digital interface which is capable of transmitting high-definition video and high-resolution audio over a single cable. Its interface is available through connector CN10.

Pin	Signal	Pin	Signal
1	HDMI OUT_DATA2+	2	GND
3	HDMI OUT_DATA2-	4	HDMI OUT_DATA1+
5	GND	6	HDMI OUT_DATA1-
7	HDMI OUT_DATA0+	8	GND
9	HDMI OUT_DATA0-	10	HDMI OUT_Clock+
11	GND	12	HDMI OUT_Clock-
13	CEC	14	N.C.
15	HDMI OUT_SCL	16	HDMI OUT_SDA
17	GND	18	+5V
19	HDMI_HTPLG		

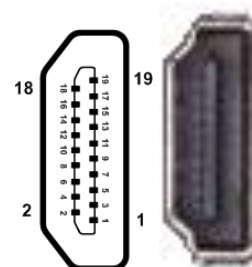

3.3.6 LAN Connector (LAN1, LAN2)

The RJ-45 connector is for Ethernet. To connect the board to a 1000/100/10 Base-T hub, just plug one end of the cable into connector and connect the other end (phone jack) to a 1000/100/10-Base-T hub.

Pin	Signal	Pin	Signal
L1	MDI0+	L5	MDI2-
L2	MDI0-	L6	MDI1-
L3	MDI1+	L7	MDI3+
L4	MDI2+	L8	MDI3-
A	Active LED (Yellow)		
B	100 LAN LED (Green)/ 1000 LAN LED (Orange)		

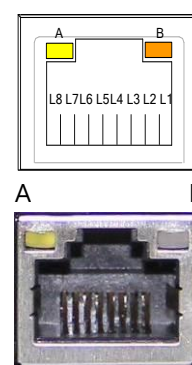

3.3.7 USB Connector

The Universal Serial Bus connectors are compliant with USB 2.0 (480Mbps), and ideally for installing USB peripherals such as keyboard, mouse, scanner, etc.

Pin	Signal USB Port 0	Pin	Signal USB Port 1
1	USB VCC (+5V level)	5	USB VCC (+5V level)
2	USB #0_D-	6	USB #1_D-
3	USB #0_D+	7	USB #1_D+
4	Ground (GND)	8	Ground (GND)

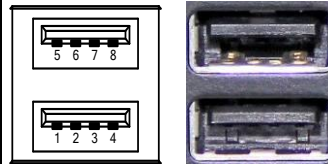

3.3.8 ATX Power On/OFF Button

The ATX power button is on the I/O side. It can allow users to control eBOX620-841-FL power on/off.

Pin	Signal
1	GND
2	PSIN

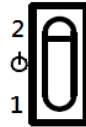

3.3.9 Audio Connector

These two audio jacks ideal are for Audio Mic-In and Audio Line-out.

Pin	Signal
1	Microphone In
2	Line Out



3.3.10 Digital I/O Connector

The onboard digital I/O has 8 bits (DIO0~7). Each bit can be set to function as input or output by software programming. The BIOS default settings are 3 inputs and 5 outputs

Pin	Description
1	DO0
2	DO1
3	DO2
4	DO3
5	DO4
6	DI0
7	DI1
8	DI2
9	GND

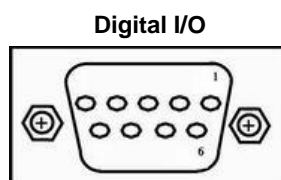

3.3.11 SATA Connector

This Serial Advanced Technology Attachment (Serial ATA or SATA) connector is for high-speed SATA interface. It is a computer bus interface for connecting to devices such as hard disk drive.

Pin	Signal
1	GND
2	SATA_TX+
3	SATA_TX-
4	GND
5	SATA_RX-
6	SATA_RX+
7	GND

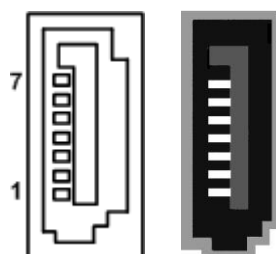

3.3.12 SATA Power Connector

Use CN12 for interfacing to SATA 2.5" HDD power supply.

Pin	Signal
1	+12V level
2	GND
3	GND
4	+5V level

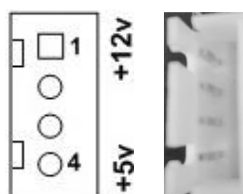

3.3.13 CFast™ slot

The board is equipped with a CFast™ socket on the bottom side to support a CFast™ card which is based on the SATA bus. The socket is specially designed to avoid incorrect installation of the CFast™ card. When installing or removing the CFast™ card, please make sure the system power is off. The CFast™ card by default identifies itself as C: or D: drive in your PC system.

Pin	Signal	Pin	Signal
1	GND	13	N.C
2	SATA_TX+	14	GND
3	SATA_TX-	15	N.C
4	GND	16	CFAST_LED#
5	SATA_RX-	17	N.C
6	SATA_RX+	18	N.C
7	GND	19	N.C
8	N.C	20	+3.3V Level
9	GND	21	+3.3V Level
10	N.C	22	GND
11	N.C	23	GND
12	N.C	24	N.C

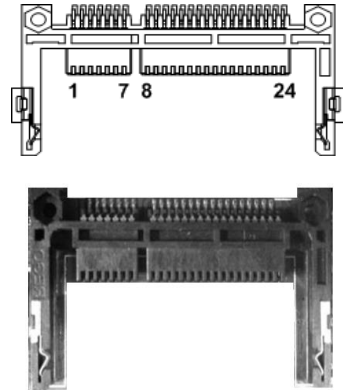

3.3.14 Half-Size PCI Express Mini card Slot (SCN1)

The SCN1 is a half-size PCI-Express Mini Card connector. It supports the PCI-Express Mini Cards which are applied to either PCI-Express x1 or USB. It complies with PCI-Express Mini Card Spec. V1.2.

Pin	Signal	Pin	Signal
1	WAKE#	2	+3.3VSB
3	No use	4	GND
5	No use	6	+1.5V
7	CLKREQ#	8	No use
9	GND	10	No use
11	REFCLK-	12	No use
13	REFCLK+	14	No use
15	GND	16	No use
17	No use	18	GND
19	No use	20	W_DISABLE#
21	GND	22	PERST#
23	PE_RXN3	24	+3.3VSB
25	PE_RXP3	26	GND
27	GND	28	+1.5V
29	GND	30	SMB_CLK
31	PE_TXN3	32	SMB_DATA
33	PE_TXP3	34	GND
35	GND	36	USB_D8-
37	GND	38	USB_D8+
39	+3.3VSB	40	GND
41	+3.3VSB	42	No use
43	GND	44	No use
45	No use	46	No use
47	No use	48	+1.5V
49	No use	50	GND
51	No use	52	+3.3VSB

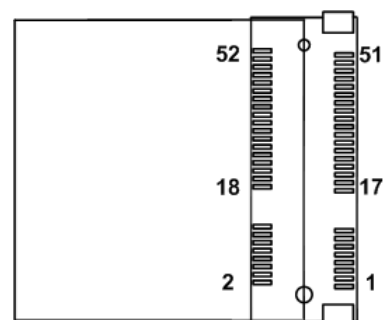

3.3.15 Full-Size PCI Express Mini Card Slot (SCN2)

This is a PCI-Express Mini Card connector on the bottom side applying to either PCI-Express or USB 2.0 or **SATA (mSATA)**. It complies with PCI-Express Mini Card Spec. V1.2. It can also support mSATA cards. Please refer to BIOS setting to enable or disable mSATA support.

Pin	Signal	Pin	Signal
1	WAKE#	2	+3.3VSB
3	No use	4	GND
5	No use	6	+1.5V
7	CLKREQ#	8	No use
9	GND	10	No use
11	REFCLK-	12	No use
13	REFCLK+	14	No use
15	GND	16	No use
17	No use	18	GND
19	No use	20	W_DISABLE#
21	GND	22	PERST#
23	PE_RXN3/ SATA_RXP	24	+3.3VSB
25	PE_RXP3/ SATA_RXN	26	GND
27	GND	28	+1.5V
29	GND	30	SMB_CLK
31	PE_TXN3/ SATA_TXN	32	SMB_DATA
33	PE_TXP3/ SATA_TXP	34	GND
35	GND	36	USB_D8-
37	GND	38	USB_D8+
39	+3.3VSB	40	GND
41	+3.3VSB	42	No use
43	GND	44	No use
45	No use	46	No use
47	No use	48	+1.5V
49	No use	50	GND
51	No use	52	+3.3VSB

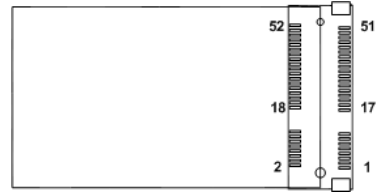

3.3.16 SIM Card Slot (SCN3)

This board has SCN3 socket on the bottom side for inserting SIM Card. In order to work properly, the SIM Card must be used together with 3G module which is inserted to SCN1 or SCN2. It is mainly used in 3G wireless network application.

Pin	Signal
1	PWR
2	RST
3	CLK
4	NC
5	GND
6	VPP
7	I/O
8	NC

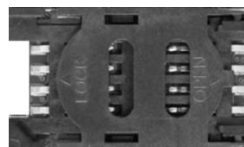
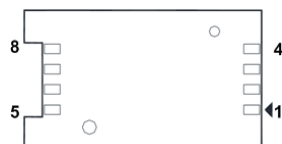

This page is intentionally left blank.

CHAPTER 4

BIOS SETUP UTILITY

This chapter provides users with detailed description how to set up basic system configuration through the BIOS setup utility.

4.1 Starting

To enter the setup screens, follow the steps below:

1. Turn on the computer and press the key immediately.
2. After you press the key, the main BIOS setup menu displays. You can access the other setup screens from the main BIOS setup menu, such as the Advanced and Chipset menus.

It is strongly recommended that you should avoid changing the chipset's defaults. Both AMI and your system manufacturer have carefully set up these defaults that provide the best performance and reliability.

4.2 Navigation Keys

The BIOS setup/utility uses a key-based navigation system called hot keys. Most of the BIOS setup utility hot keys can be used at any time during the setup navigation process. These keys include <F1>, <F2>, <Enter>, <ESC>, <Arrow> keys, and so on.



NOTE: Some of the navigation keys differ from one screen to another.

Hot Keys	Description
→← Left/Right	The Left and Right <Arrow> keys allow you to select a setup screen.
↑↓ Up/Down	The Up and Down <Arrow> keys allow you to select a setup screen or sub-screen.
+– Plus/Minus	The Plus and Minus <Arrow> keys allow you to change the field value of a particular setup item.
Tab	The <Tab> key allows you to select setup fields.
F1	The <F1> key allows you to display the General Help screen.
F2	The <F2> key allows you to Load Previous Values.
F3	The <F3> key allows you to Load Optimized Defaults.
F4	The <F4> key allows you to save any changes you have made and exit Setup. Press the <F4> key to save your changes.
Esc	The <Esc> key allows you to discard any changes you have made and exit the Setup. Press the <Esc> key to exit the setup without saving your changes.
Enter	The <Enter> key allows you to display or change the setup option listed for a particular setup item. The <Enter> key can also allow you to display the setup sub- screens.

4.3 Main Menu

When you first enter the setup utility, you will enter the Main setup screen. You can always return to the Main setup screen by selecting the Main tab. System Time/Date can be set up as described below. The Main BIOS setup screen is shown below.

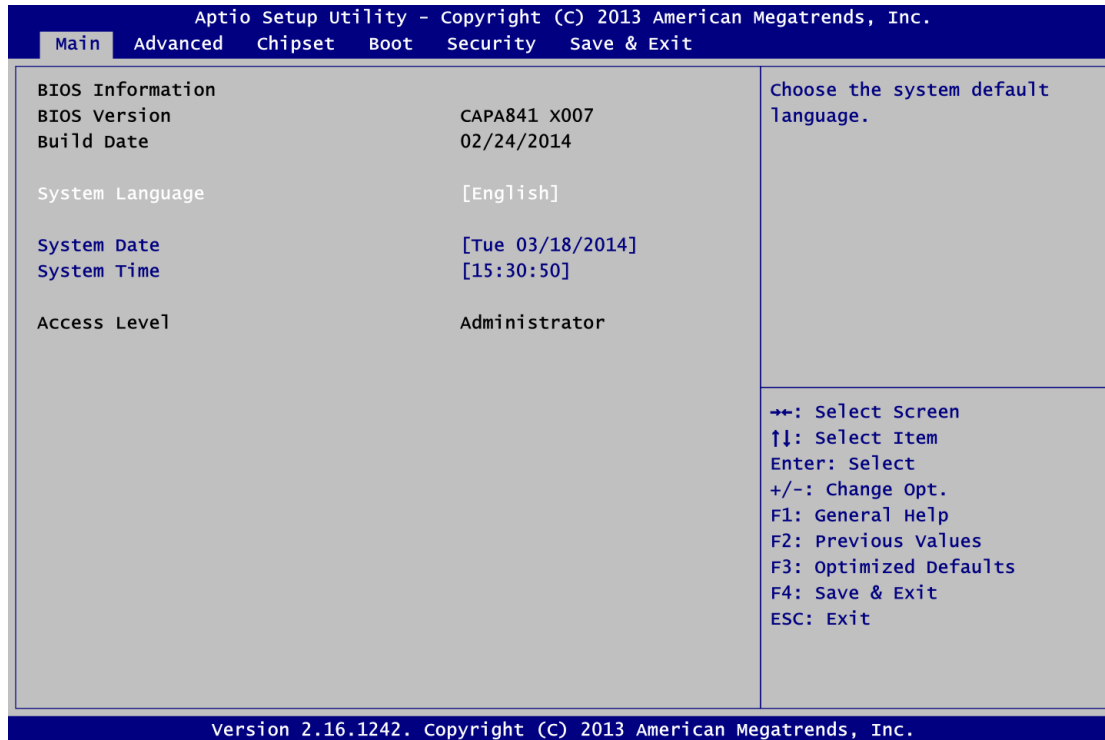

BIOS/Memory Information

Display the auto-detected BIOS/memory information.

System Language

Choose the system default language.

System Date/Time

Use this option to change the system time and date. Highlight System Time or System Date using the <Arrow> keys. Enter new values through the keyboard. Press the <Tab> key or the <Arrow> keys to move between fields. The date must be entered in MM/DD/YY format. The time is entered in HH:MM:SS format.

Access Level

Display the access level of current user.

4.4 Advanced Menu

The Advanced menu also allows users to set configuration of the CPU and other system devices. You can select any of the items in the left frame of the screen to go to the sub menus:

- ▶ ACPI Settings
- ▶ NCT6106D Super IO Configuration
- ▶ NCT6106D HW Monitor
- ▶ CPU Configuration
- ▶ IDE Configuration
- ▶ Trusted Computing
- ▶ USB Configuration

For items marked with “▶”, please press <Enter> for more options.

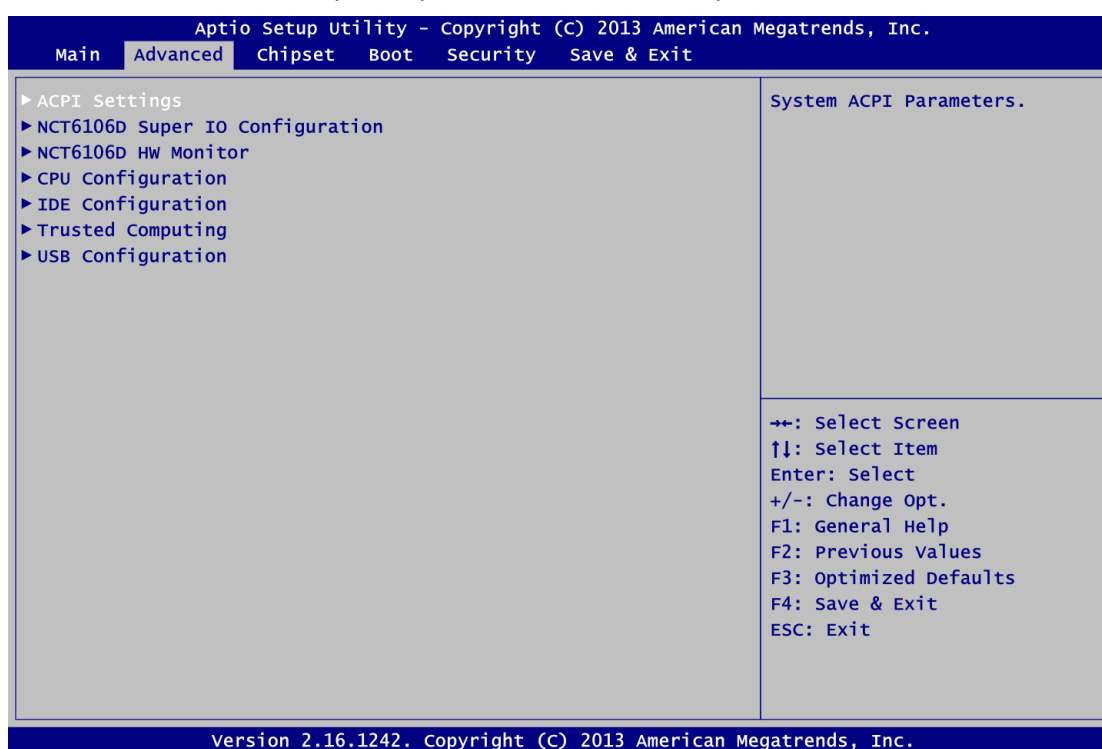

- **ACPI Settings**

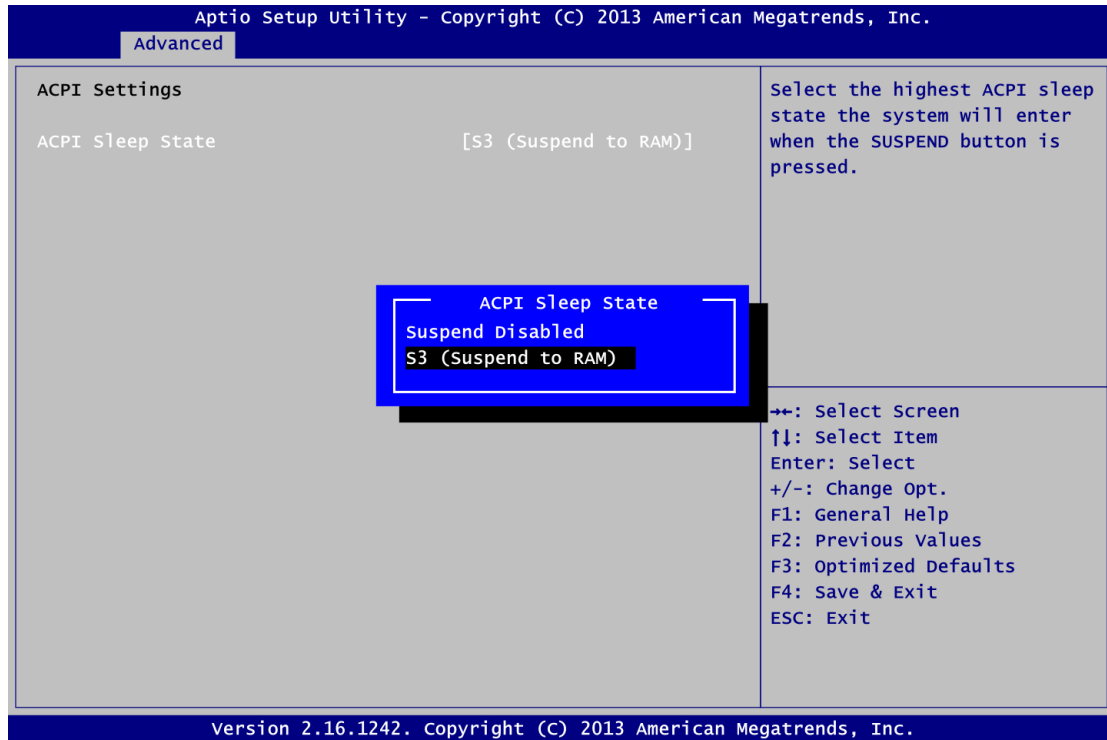

ACPI Sleep State

When the sleep button is pressed, the system will be in the ACPI sleep state. The default is S3 (Suspend to RAM).

- **NCT6106D Super IO Configuration**

You can use this screen to select options for the Super IO Configuration, and change the value of the selected option. A description of the selected item appears on the right side of the screen. For items marked with "▶", please press <Enter> for more options.

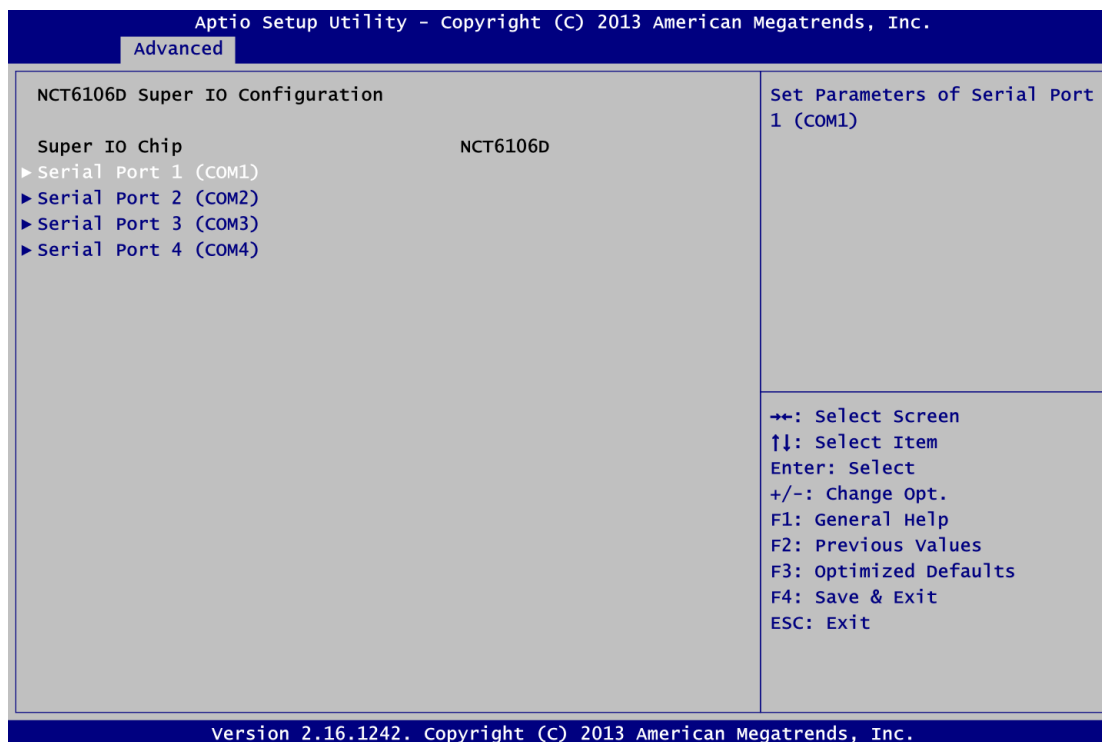

Serial Port 1~4 (COM1~4) Configuration

Use these items to set parameters related to serial port 1~4.

- **Serial Port 1 (COM1) Configuration**

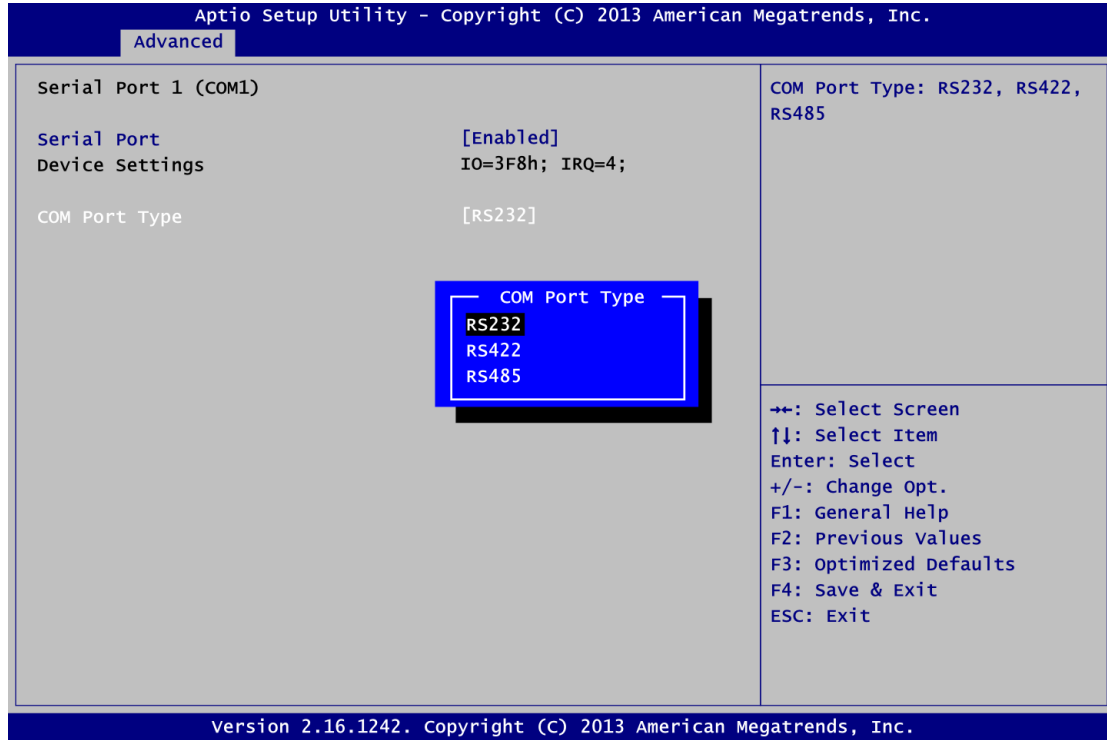

Serial Port

Enable or disable serial port 1. The optimal setting for base I/O address is 3F8h and for interrupt request address is IRQ4.

COM Port Type

Use this option to set RS-232/RS-422/RS-485 mode.

- **Serial Port 2 (COM2) Configuration**

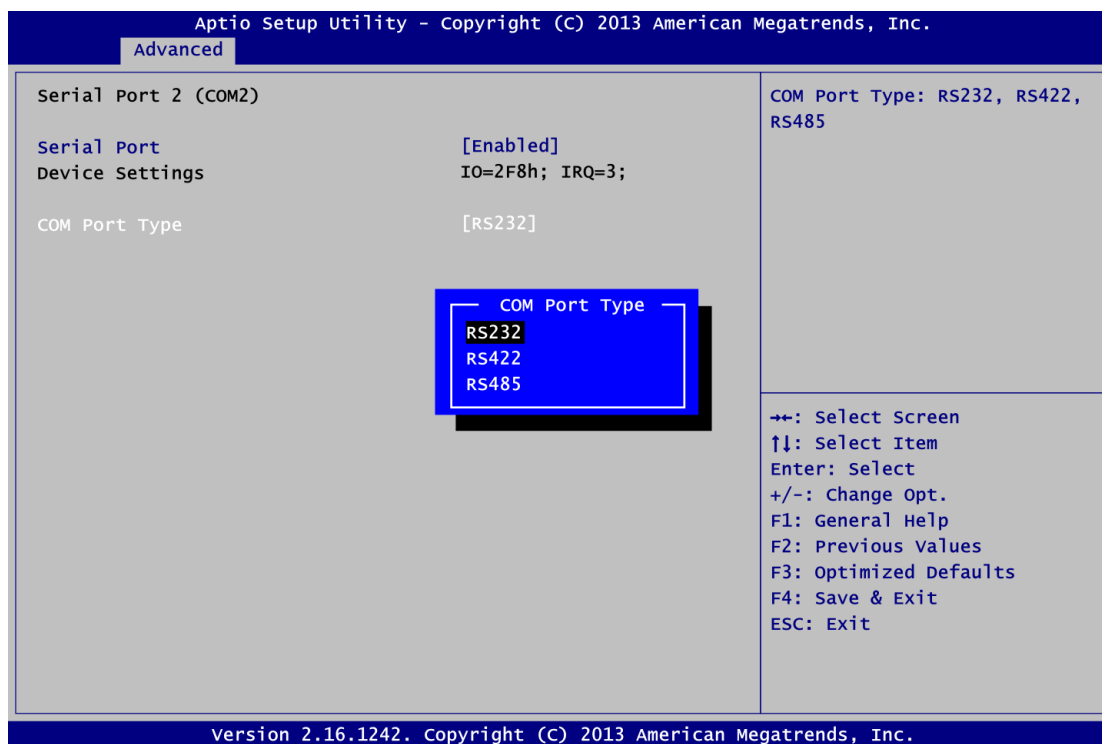

Serial Port

Enable or disable serial port 2. The optimal setting for base I/O address is 2F8h and for interrupt request address is IRQ3.

COM Port Type

Use this option to set RS-232/RS-422/RS-485 mode.

- **NCT6106D HW Monitor**

This screen monitors hardware health status.

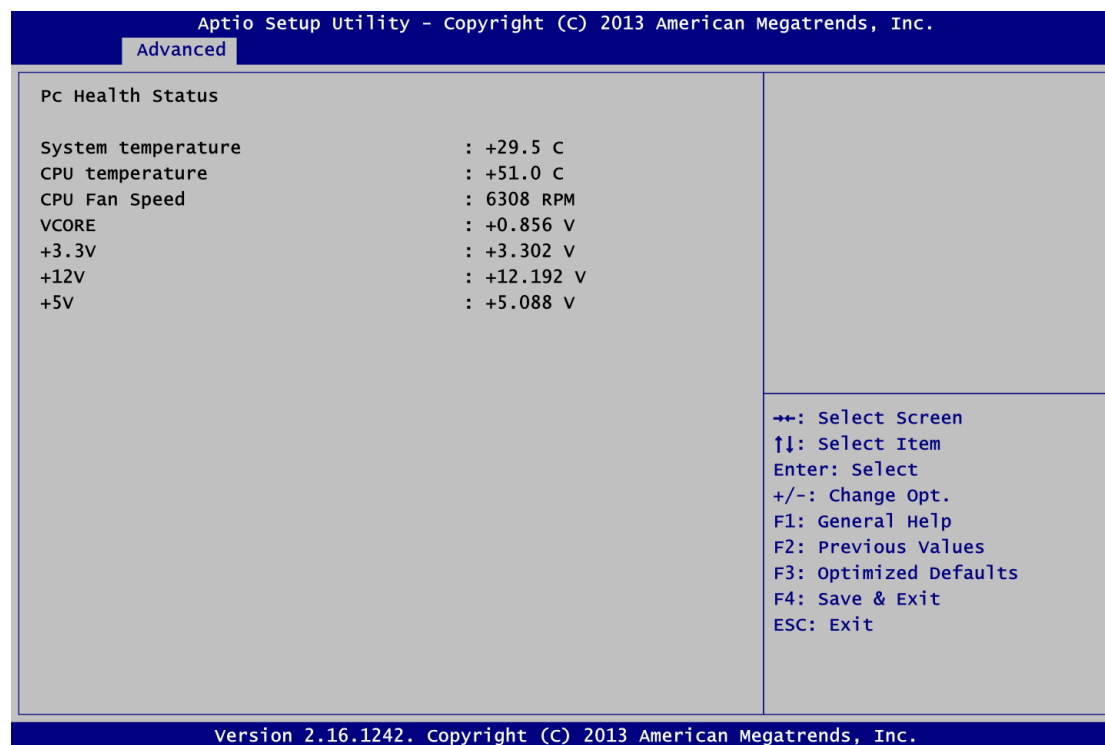

This screen displays the temperature of system and CPU, cooling fan speed in RPM and system voltages (VCORE, +3.3V, +12V and +5V).

- **CPU Configuration**

This screen shows the CPU Configuration.

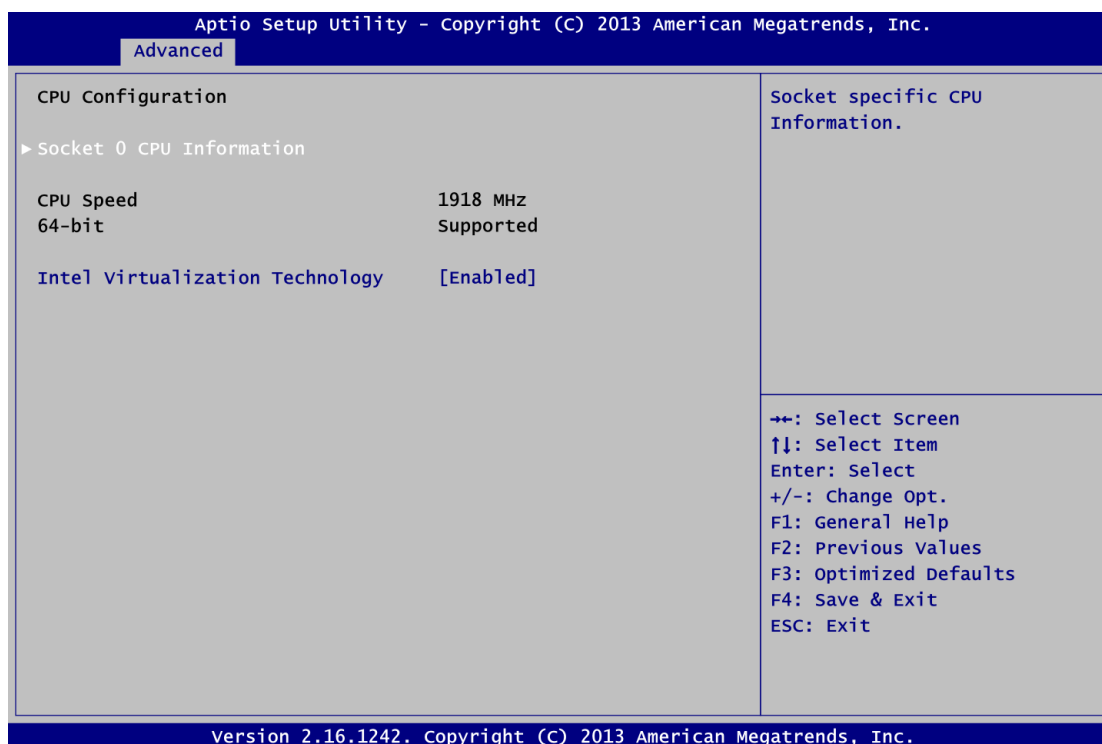

Socket 0 CPU Information

This item is for socket specific CPU information.

Intel Virtualization Technology

Allow a hardware platform to run multiple operating systems separately and simultaneously, enabling one system to virtually function as several systems.

- **IDE Configuration**

In the IDE Configuration menu, you can see the currently installed hardware in the SATA ports. During system boot up, the BIOS automatically detects the presence of SATA devices.

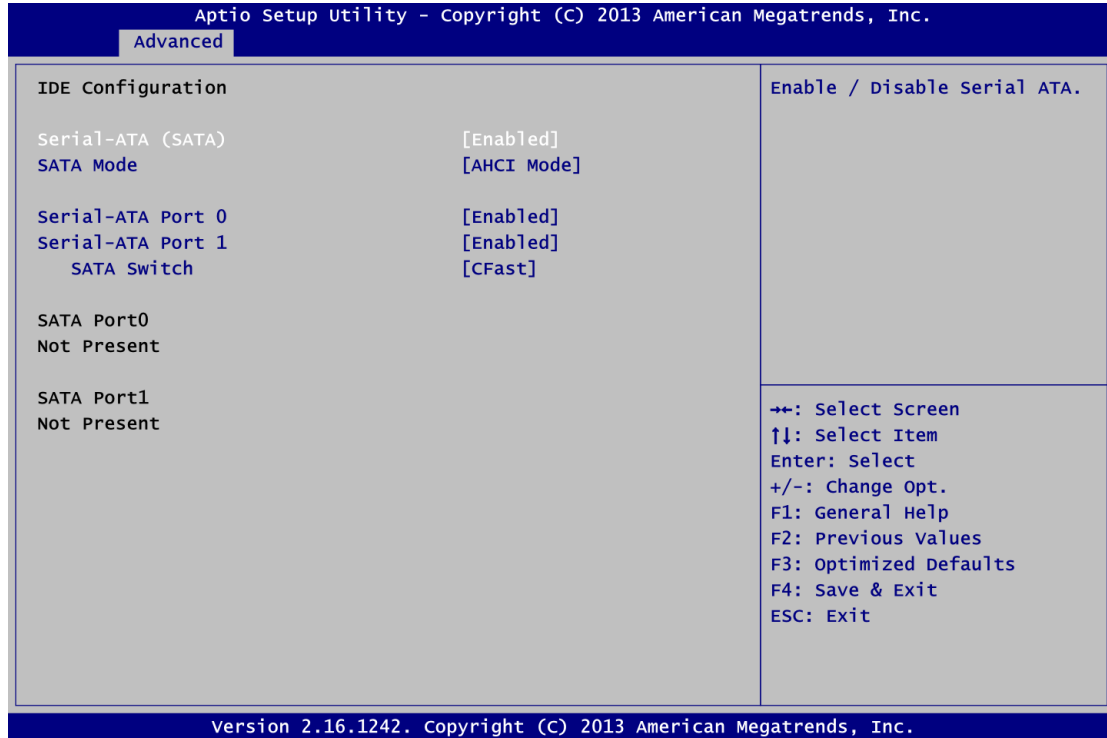

Serial-ATA (SATA)

Enable or disable the SATA Controller feature. The default is Enabled.

SATA Mode Selection

Determine how SATA controller(s) operate. Operation mode options are IDE Mode and AHCI (Advanced Host Controller Interface) Mode. The default is AHCI Mode.

Serial-ATA Port 0

Enable or disable the onboard SATA port 0.

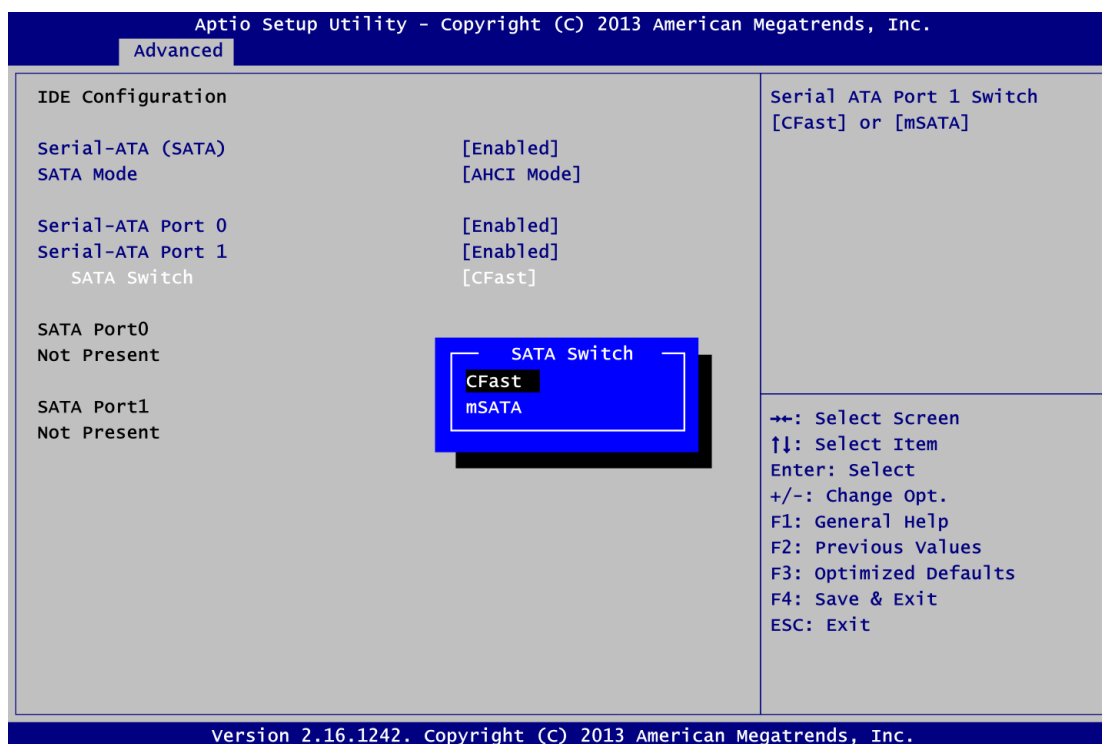

Serial-ATA Port 1

Enable or disable the onboard SATA port 1.

SATA Switch

This option appears only after SATA Port 1 is enabled. The default is CFast. If you intend to insert mSATA card to SCN2, please change setting to mSATA.

- **Trusted Computing**

This screen provides function for specifying the TPM settings.

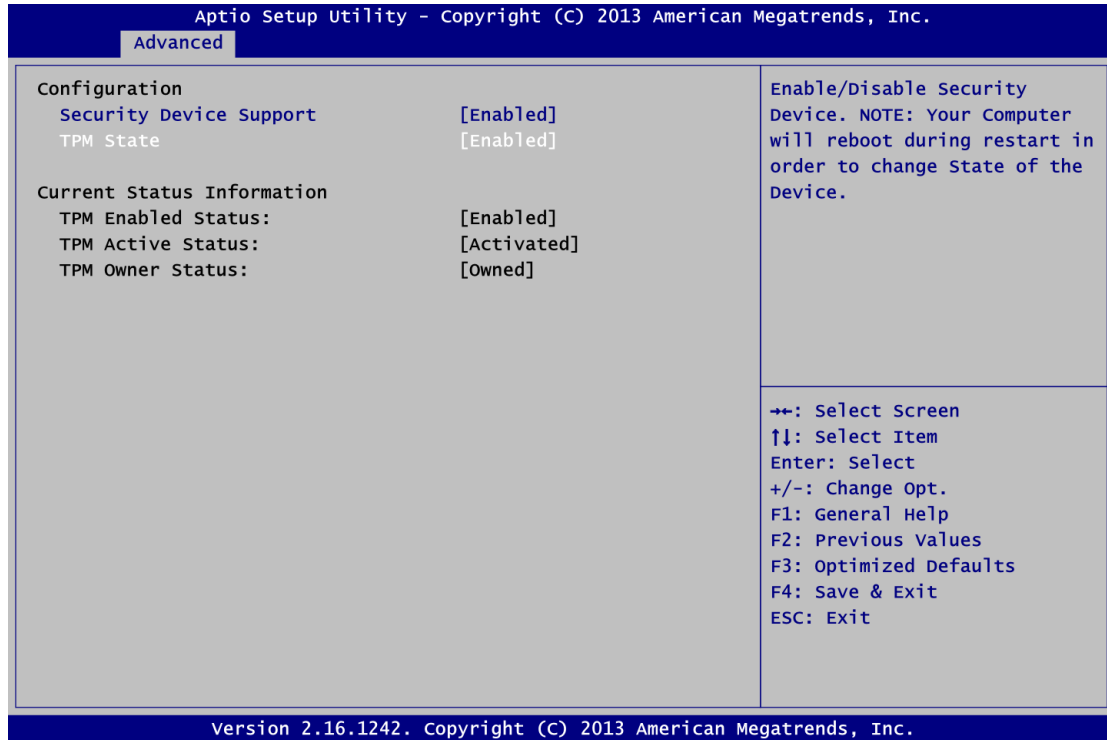

Security Device Support

Enable or disable BIOS support for security device. The default setting is Disabled.

TPM State

Once the Security Device Support is Enabled, TPM can be used by the operating system.

Current Status Information

Display current TPM status information.

● USB Configuration

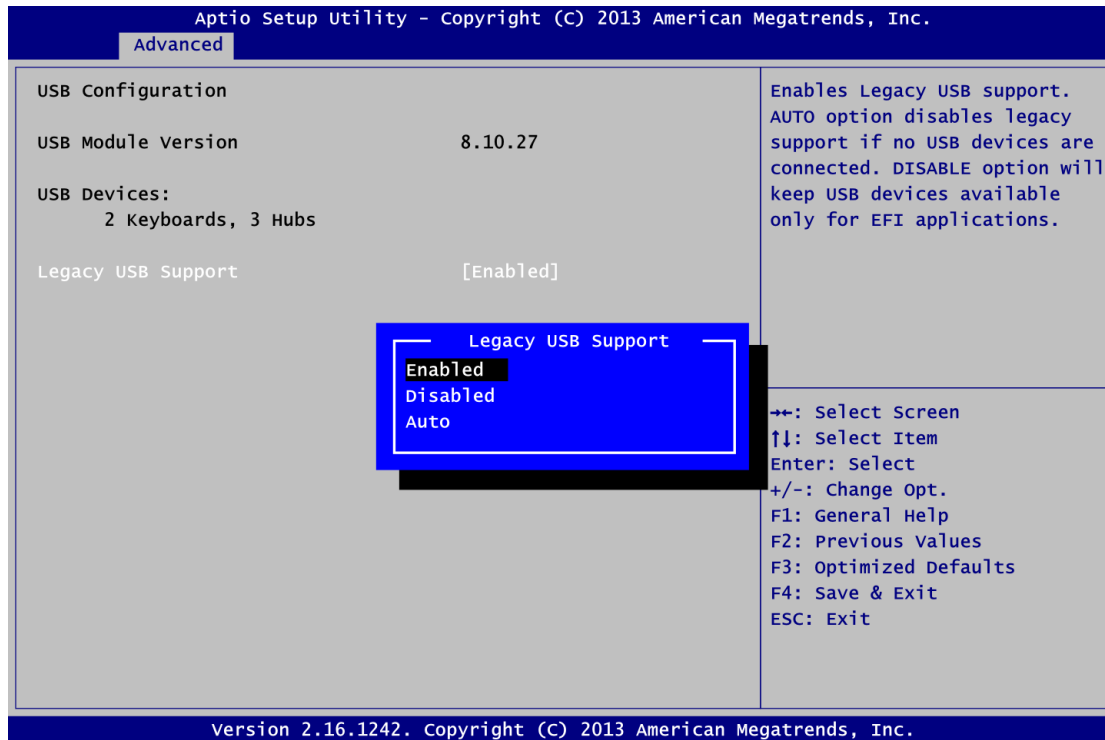

USB Devices

Display all detected USB devices.

Legacy USB Support

Use this item to enable or disable support for USB device on legacy operating system. The default setting is Enabled. Auto option disables legacy support if no USB devices are connected. Disable option will keep USB devices available only for EFI applications.

4.5 Chipset Menu

The Chipset menu allows users to change the advanced chipset settings. You can select any of the items in the left frame of the screen to go to the sub menus:

- ▶ North Bridge
- ▶ South Bridge

For items marked with “▶”, please press <Enter> for more options.

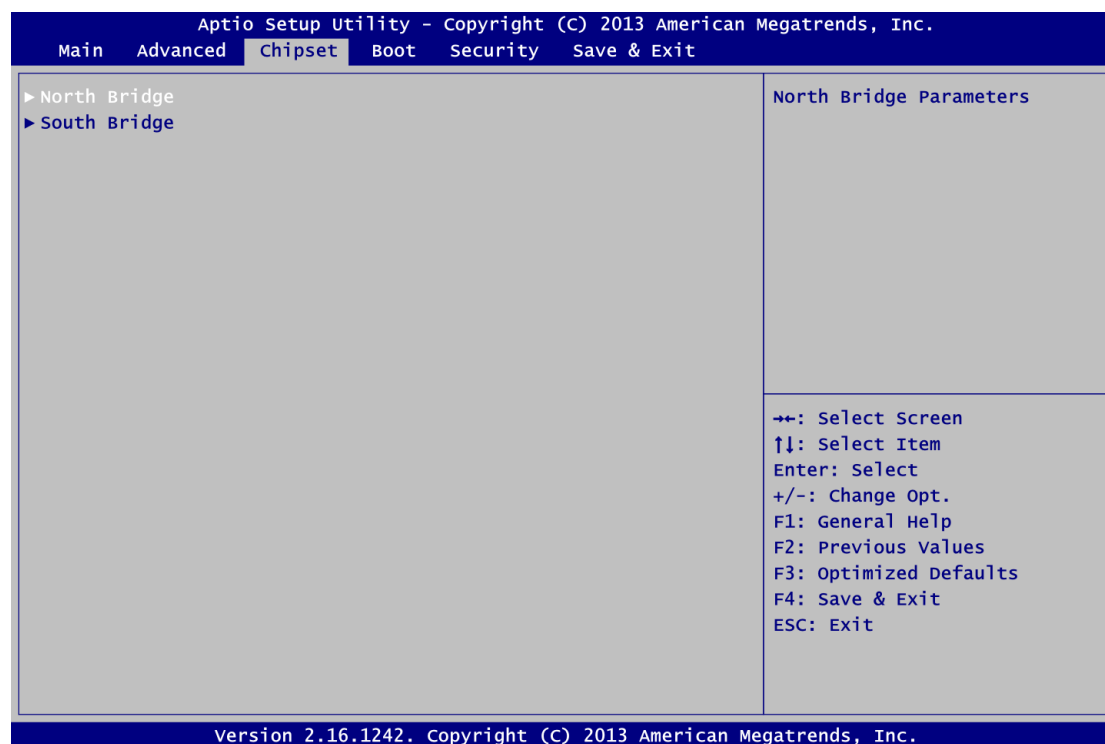

● North Bridge

Aptio Setup Utility - Copyright (C) 2013 American Megatrends, Inc.		
Chipset		
Memory Information		Select LCD panel used by DP Device by selecting the appropriate setup item.
Total Memory	8192 MB (LPDDR3)	
Memory Slot0	8192 MB (LPDDR3)	
		→←: Select Screen ↑↓: Select Item Enter: Select +/-: Change Opt. F1: General Help F2: Previous Values F3: Optimized Defaults F4: Save & Exit ESC: Exit
Version 2.16.1242. Copyright (C) 2013 American Megatrends, Inc.		

- **South Bridge**

This screen allows users to configure parameters of South Bridge chipset.

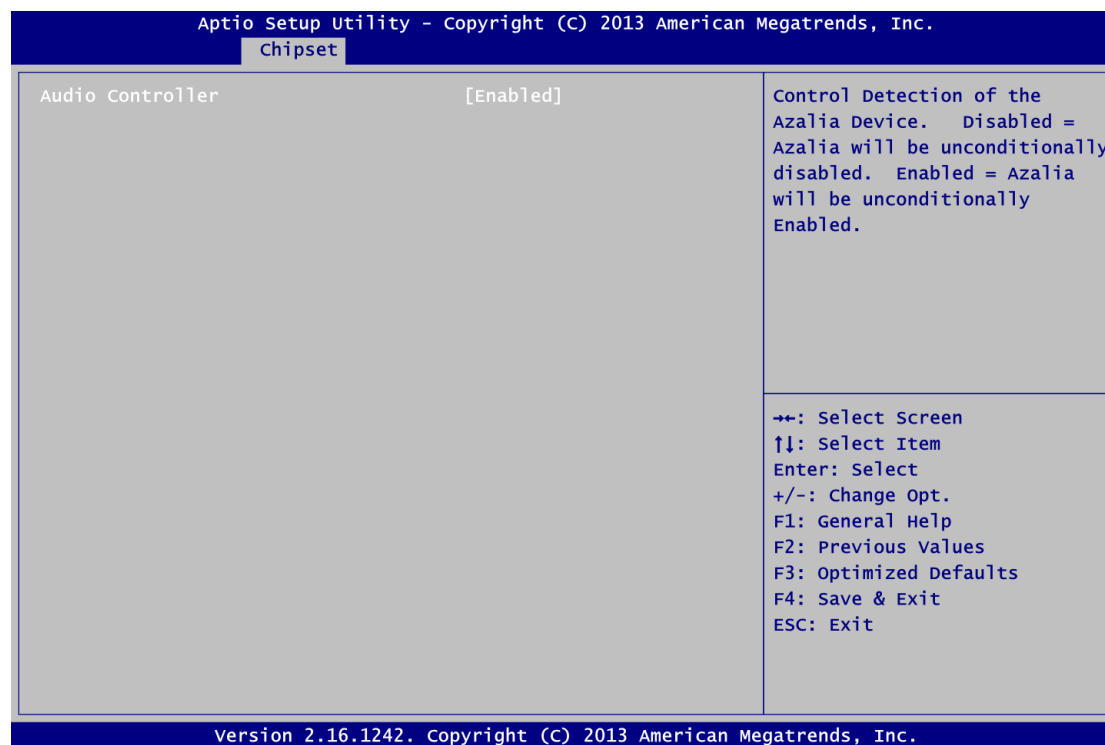

Audio Controller

Control detection of the Azalia device.
Disabled - Azalia will be unconditionally disabled.
Enabled - Azalia will be unconditionally enabled.

4.6 Boot Menu

The Boot menu allows users to change boot options of the system.

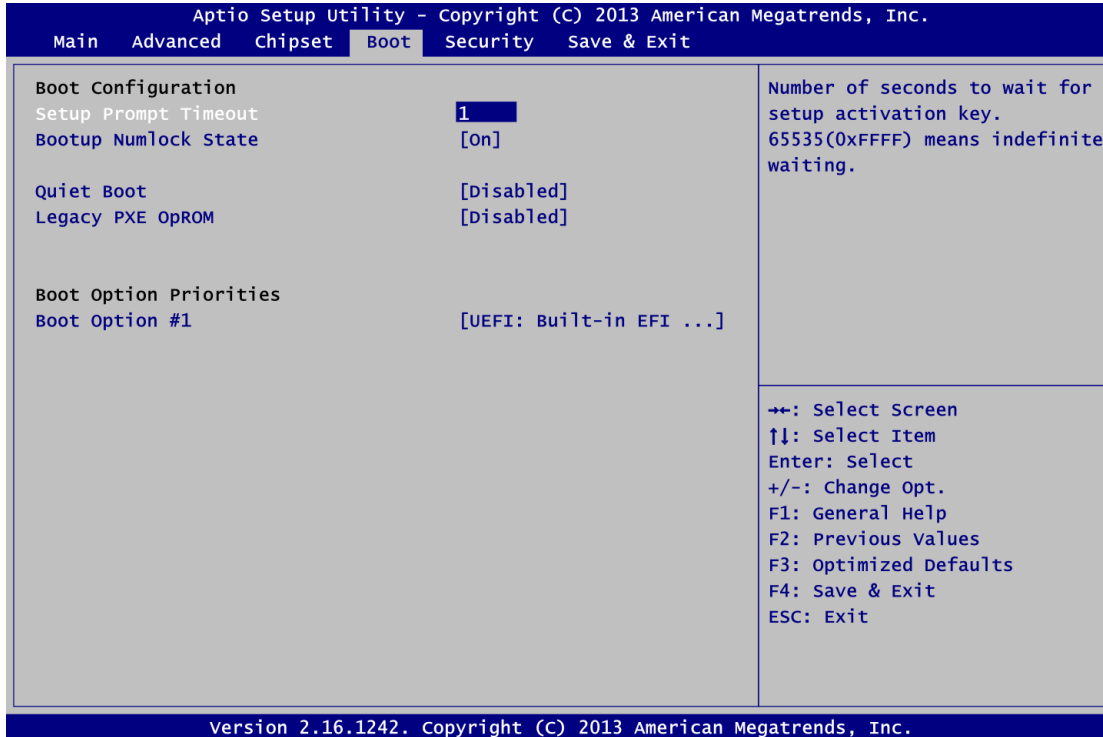

Setup Prompt Timeout

Number of seconds to wait for setup activation key. 65535(0xFFFF) means indefinite waiting.

Bootup NumLock State

Use this item to select the power-on state for the keyboard NumLock.

Quiet Boot

Select to display either POST output messages or a splash screen during boot-up.

Launch PXE OpROM

Use this item to enable or disable the boot ROM function of the onboard LAN chip when the system boots up.

Boot Option Priorities

These are settings for boot priority. Specify the boot device priority sequence from the available devices.

4.7 Security Menu

The Security menu allows users to change the security settings for the system.



Administrator Password

This item indicates whether an administrator password has been set (installed or uninstalled).

User Password

This item indicates whether an user password has been set (installed or uninstalled).

4.8 Save & Exit Menu

The Save & Exit menu allows users to load your system configuration with optimal or fail-safe default values.

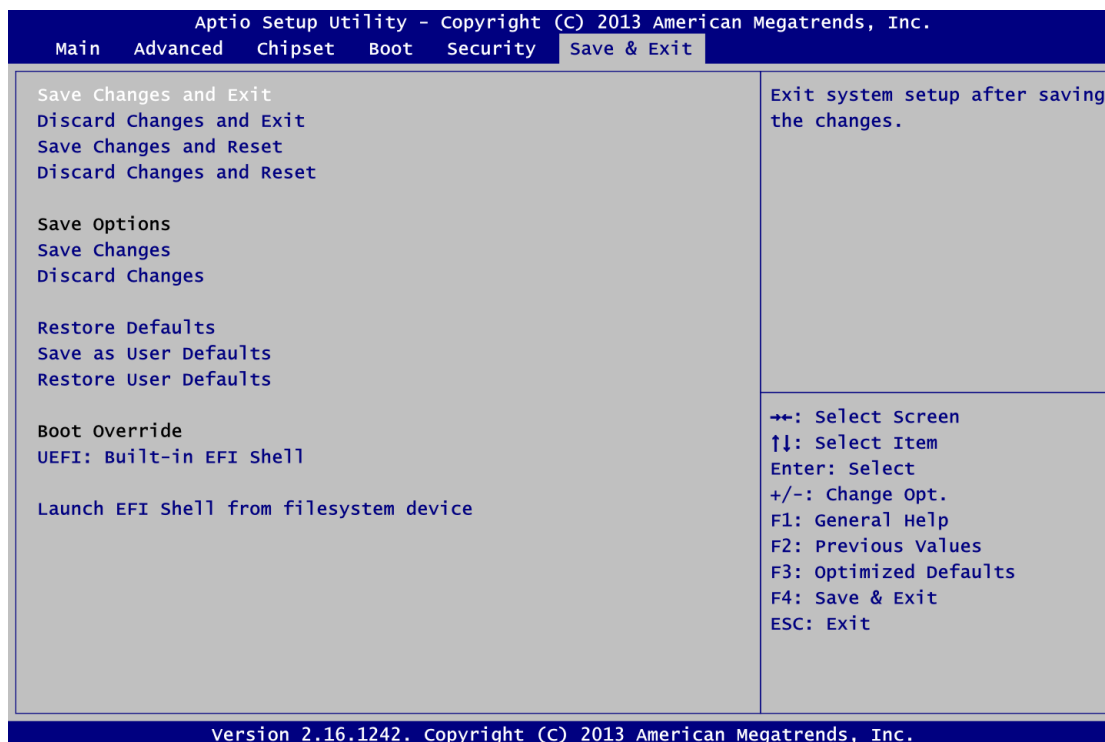

Save Changes and Exit

When you have completed the system configuration changes, select this option to leave Setup and return to Main Menu. Select Save Changes and Exit from the Save & Exit menu and press <Enter>. Select Yes to save changes and exit.

Discard Changes and Exit

Select this option to quit Setup without making any permanent changes to the system configuration and return to Main Menu. Select Discard Changes and Exit from the Save & Exit menu and press <Enter>. Select Yes to discard changes and exit.

Save Changes and Reset

When you have completed the system configuration changes, select this option to leave Setup and reboot the computer so the new system configuration parameters can take effect. Select Save Changes and Reset from the Save & Exit menu and press <Enter>. Select Yes to save changes and reset.

Discard Changes and Reset

Select this option to quit Setup without making any permanent changes to the system configuration and reboot the computer. Select Discard Changes and Reset from the Save & Exit menu and press <Enter>. Select Yes to discard changes and reset.

Save Changes

When you have completed the system configuration changes, select this option to save changes. Select Save Changes from the Save & Exit menu and press <Enter>. Select Yes to save changes.

Discard Changes

Select this option to quit Setup without making any permanent changes to the system configuration. Select Discard Changes from the Save & Exit menu and press <Enter>. Select Yes to discard changes.

Restore Defaults

It automatically sets all Setup options to a complete set of default settings when you select this option. Select Restore Defaults from the Save & Exit menu and press <Enter>.

Save as User Defaults

Select this option to save system configuration changes done so far as User Defaults. Select Save as User Defaults from the Save & Exit menu and press <Enter>.

Restore User Defaults

It automatically sets all Setup options to a complete set of User Defaults when you select this option. Select Restore User Defaults from the Save & Exit menu and press <Enter>.

Boot Override

Select a drive to immediately boot that device regardless of the current boot order.

Launch EFI Shell from filesystem device

Attempt to launch EFI Shell application (Shellx64.efi) from one of the available filesystem devices.

APPENDIX A WATCHDOG TIMER

About Watchdog Timer

After the system stops working for a while, it can be auto-reset by the watchdog timer. The integrated watchdog timer can be set up in the system reset mode by program.

How to Use Watchdog Timer

The following example enables configuration using debug tool.

Enable WDT

↓

Enable configuration:

O 2E 87 ; Un-lock super I/O

O 2E 87

↓

Select logic device:

O 2E 07

O 2F 08

↓

WDT device enable:

O 2E 30

O 2F 01

↓

Set timer unit:

O 2E F0

O 2F 00 ; (00: Sec; 08:Minute)

↓

Set base timer:

O 2E F1

O 2F 0A ; Set reset time (where 0A (hex) = 10sec)

Disable WDT

↓

Enable configuration:

O 2E 87 ; Un-lock super I/O

O 2E 87

↓

Select logic device:

O 2E 07

O 2F 08

↓

WDT device disable:

O 2E 30

O 2F 00

APPENDIX B DIGITAL I/O

About Digital I/O

The onboard digital I/O has 8 bits (DIO0~7). Each bit can be set to function as input or output by software programming. In default, all pins are pulled high with +5V level (according to main power). The BIOS default settings are 3 inputs and 5 outputs where all of these pins are set to 1.

Digital I/O Programming

The following example enables configuration using debug tool.

Start digital I/O programming

↓

Enable configuration:

O 2E 87 ; Un-lock super I/O

O 2E 87

↓

Select logic device:

O 2E 07

O 2F 07

↓

Set multi-function selection:

O 2E 1C

O 2F 1C ; Open GPIO2 and close UART

↓

Set GPIO2 I/O register:

O 2E E8

O 2F 00 ; 00: Programmed to function as output port

; FF: Programmed to function as input port

↓

Set GPIO2 data register:

; Set digital output pins value

O 2E E9

O 2F 00 ; 00: Set digital output to low level

; FF: Set digital output to high level

↓

Digital Input:

; Read digital input data

O 2E E9

i 2F ; FF: Digital input data is high (default state)