



**MODEL:  
S19A/S24A-QM87i**

**Marine Panel PC with Intel® Core™ i5-4400E  
Dual-Core CPU, Intel® QM87 Express Chipset, GbE LAN,  
Four Isolated RS-232/422/485, CAN Bus, HDMI, DVI-D, VGA,  
CFast Slot, USB 2.0, USB 3.0, iRIS-2400, RoHS Compliant**

## **User Manual**

# Revision

---

Date	Version	Changes
July 23, 2018	1.10	Updated for R11 version – changed touch controller
February 21, 2018	1.02	Added some notes
December 12, 2017	1.01	Eliminate "15" from the model name to make it consistent with other panel PC models
July 8, 2015	1.00	Initial release

# Copyright

---

## **COPYRIGHT NOTICE**

The information in this document is subject to change without prior notice in order to improve reliability, design and function and does not represent a commitment on the part of the manufacturer.

In no event will the manufacturer be liable for direct, indirect, special, incidental, or consequential damages arising out of the use or inability to use the product or documentation, even if advised of the possibility of such damages.

This document contains proprietary information protected by copyright. All rights are reserved. No part of this manual may be reproduced by any mechanical, electronic, or other means in any form without prior written permission of the manufacturer.

## **TRADEMARKS**

All registered trademarks and product names mentioned herein are used for identification purposes only and may be trademarks and/or registered trademarks of their respective owners.

# Table of Contents

<b>1 INTRODUCTION.....</b>	<b>1</b>
1.1 OVERVIEW.....	2
1.2 FEATURES.....	2
1.3 FRONT PANEL.....	3
1.3.1 Display Control Buttons.....	4
1.4 TOP PANEL.....	4
1.5 BOTTOM PANEL.....	5
1.6 REAR PANEL.....	6
1.7 TECHNICAL SPECIFICATIONS.....	7
1.8 DIMENSIONS.....	10
<b>2 UNPACKING.....</b>	<b>12</b>
2.1 ANTI-STATIC PRECAUTIONS.....	13
2.2 UNPACKING PRECAUTIONS.....	13
2.3 UNPACKING CHECKLIST.....	14
2.4 OPTIONAL ITEMS.....	14
<b>3 INSTALLATION.....</b>	<b>16</b>
3.1 INSTALLATION PRECAUTIONS.....	17
3.1.1 High Surface Temperature.....	17
3.2 CFAST CARD INSTALLATION.....	18
3.3 HDD INSTALLATION.....	19
3.4 AT/ATX MODE SELECTION.....	22
3.5 MOUNTING THE SYSTEM.....	22
3.5.1 Panel Mounting.....	23
3.5.2 Stand Mounting.....	25
3.5.3 Ceiling Mounting.....	27
3.6 SERIAL DEVICE CONNECTION.....	32
3.6.1 RS-232 Serial Port (COM1).....	33
3.6.2 RS-232/422/485 Serial Port (COM2–COM5).....	33
3.7 CAN BUS CONNECTION AND CONFIGURATION.....	34

**S19A/S24A-QM87i Marine Panel PC**

3.8 POWERING ON THE SYSTEM.....	35
3.9 CLEAR CMOS.....	36
3.10 AVAILABLE DRIVERS .....	37
3.10.1 Driver Download .....	37
3.11 IPMI SETUP PROCEDURE.....	39
3.11.1 Managed System Hardware Setup.....	39
3.11.2 Using the IEI iMAN Web GUI.....	39
<b>4 ON-SCREEN-DISPLAY (OSD) CONTROLS .....</b>	<b>42</b>
4.1 USER MODE OSD STRUCTURE.....	43
4.1.1 OSD Buttons.....	43
4.1.2 OSD Menu Structure .....	44
4.2 USING THE OSD.....	45
4.2.1 Image Menu .....	45
4.2.2 System Menu .....	46
<b>5 BIOS SETUP .....</b>	<b>48</b>
5.1 INTRODUCTION.....	49
5.1.1 Starting Setup.....	49
5.1.2 Using Setup .....	49
5.1.3 Getting Help.....	50
5.1.4 BIOS Menu Bar.....	50
5.2 MAIN.....	51
5.3 ADVANCED.....	52
5.3.1 ACPI Settings.....	53
5.3.2 RTC Wake Settings.....	54
5.3.3 Trusted Computing.....	55
5.3.4 CPU Configuration.....	56
5.3.5 SATA Configuration .....	59
5.3.6 Intel Rapid Start Technology.....	60
5.3.7 AMT Configuration.....	61
5.3.8 USB Configuration.....	62
5.3.9 iWDD H/W Monitor.....	63
5.3.10 F81866 Super IO Configuration .....	64
5.3.10.1 Serial Port n Configuration.....	65

5.3.11	<i>Serial Port Console Redirection</i> .....	70
5.3.12	<i>IEI Feature</i> .....	72
5.4	<b>CHIPSET</b> .....	73
5.4.1	<i>PCH-IO Configuration</i> .....	73
5.4.2	<i>System Agent (SA) Configuration</i> .....	75
5.4.2.1	<i>Graphics Configuration</i> .....	76
5.4.3	<i>Memory Configuration</i> .....	78
5.5	<b>BOOT</b> .....	78
5.6	<b>SECURITY</b> .....	80
5.7	<b>SAVE &amp; EXIT</b> .....	81
5.8	<b>SERVER MANAGEMENT</b> .....	82
5.8.1	<i>System Event Log</i> .....	83
5.8.2	<i>BMC Network Configuration</i> .....	85
<b>6</b>	<b>MAINTENANCE</b> .....	<b>86</b>
6.1	<b>SYSTEM MAINTENANCE OVERVIEW</b> .....	87
6.2	<b>SO-DIMM REPLACEMENT PROCEDURE</b> .....	87
<b>7</b>	<b>INTERFACE CONNECTORS</b> .....	<b>91</b>
7.1	<b>PERIPHERAL INTERFACE CONNECTORS</b> .....	92
7.2	<b>INTERNAL PERIPHERAL CONNECTORS</b> .....	94
7.2.1	<i>Audio Connector (AUDIO1)</i> .....	95
7.2.2	<i>Battery Connector (BAT1)</i> .....	95
7.2.3	<i>Chassis Intrusion Connector (CHASSIS1)</i> .....	95
7.2.4	<i>Digital I/O Connector (DIO1)</i> .....	96
7.2.5	<i>EC Debug Connector (LPT_DB1)</i> .....	96
7.2.6	<i>Fan Connector (CPU_FAN1)</i> .....	96
7.2.7	<i>Front Panel Connector (F_PANEL1)</i> .....	97
7.2.8	<i>IPMI LED Connector (IPMI_LED1)</i> .....	97
7.2.9	<i>LAN Active LED Connector (LAN_ACT_LED1)</i> .....	97
7.2.10	<i>PCIe Mini Slots (MINI-PCIE1, MINI-PCIE2)</i> .....	97
7.2.11	<i>Power Connector (PWR1)</i> .....	98
7.2.12	<i>Power Button Connector (PWR_BTN1)</i> .....	99
7.2.13	<i>PS_ON Connector (PS_ON1)</i> .....	99
7.2.14	<i>RS-232/422/485 Connector (COM2, COM3, COM4, COM5)</i> .....	99

## S19A/S24A-QM87i Marine Panel PC

7.2.15 SATA Connector (S_ATA1).....	99
7.2.16 SATA Connector (S_ATA2).....	100
7.2.17 SATA Power Connector (SATA_PWR1).....	100
7.2.18 SATA Power Connector (SATA_PWR2).....	101
7.2.19 SMBus Connector, EC (SMB1).....	101
7.2.20 SPI Flash Connector (SPI1).....	101
7.2.21 SPI Flash Connector, EC (CN2).....	102
7.2.22 TPM Connector (TPM1).....	102
<b>7.3 EXTERNAL INTERFACE PANEL CONNECTORS .....</b>	<b>102</b>
7.3.1 CAN Bus Connector (CAN1).....	103
7.3.2 DVI Connector (DVI).....	103
7.3.3 VGA Connector (VGA1).....	104
7.3.4 HDMI Connector (HDMI1).....	104
7.3.5 GbE Connectors (LAN1/2-CN1).....	105
7.3.6 RS-232 Serial Port (COM1).....	105
7.3.7 USB 2.0 Connectors (USB1).....	105
7.3.8 USB 3.0 Connectors (USB3_CN1).....	106
<b>A REGULATORY COMPLIANCE .....</b>	<b>107</b>
<b>B SAFETY PRECAUTIONS .....</b>	<b>112</b>
B.1 SAFETY PRECAUTIONS.....	113
B.1.1 General Safety Precautions.....	113
B.1.2 Anti-static Precautions .....	114
B.1.3 Product Disposal.....	115
B.2 MAINTENANCE AND CLEANING PRECAUTIONS .....	115
B.2.1 Maintenance and Cleaning.....	115
B.2.2 Cleaning Tools.....	116
<b>C BIOS MENU OPTIONS.....</b>	<b>117</b>
C.1 BIOS CONFIGURATION OPTIONS .....	118
<b>D WATCHDOG TIMER .....</b>	<b>120</b>
<b>E HAZARDOUS MATERIALS DISCLOSURE .....</b>	<b>123</b>

# List of Figures

Figure 1-1: S19A-QM87i Marine Panel PC .....	2
Figure 1-2: S24A-QM87i Front Panel .....	3
Figure 1-3: Display Control Buttons .....	4
Figure 1-4: Top Panel .....	4
Figure 1-5: Bottom Panel .....	6
Figure 1-6: S19A-QM87i Rear Panel.....	6
Figure 1-7: S19A-QM87i Dimensions (mm).....	10
Figure 1-8: S24A-QM87i Dimensions (mm).....	11
Figure 3-1: CFast Slot Cover Retention Screw.....	18
Figure 3-2: CFast Card Installation .....	18
Figure 3-3: SBOX Computer Retention Screws.....	19
Figure 3-4: Bottom Cover Retention Screws .....	20
Figure 3-5: HDD Bracket Retention Screws.....	20
Figure 3-6: Inserting the HDD.....	21
Figure 3-7: Installing the HDD .....	21
Figure 3-8: AT/ATX Mode Selection.....	22
Figure 3-9: S19A-QM87i Cutout Dimensions .....	23
Figure 3-10: S24A-QM87i Cutout Dimensions .....	23
Figure 3-11: S19A-QM87i Panel Mounting Hole Covers .....	24
Figure 3-12: S24A-QM87i Panel Mounting Hole Covers .....	24
Figure 3-13: Tighten the Panel Mounting Clamp Screws .....	25
Figure 3-14: S19A-QM87i Stand Mounting Screw Holes .....	26
Figure 3-15: S24A-QM87i Stand Mounting Screw Holes .....	26
Figure 3-16: Installing Stand .....	27
Figure 3-17: Stand Mounting Method 2 .....	27
Figure 3-18: Locations of Bracket Screw Holes for S19A-QM87i.....	28
Figure 3-19: Locations of Bracket Screw Holes for S24A-QM87i.....	28
Figure 3-20: Ceiling Mounting Bracket Adjustment.....	29
Figure 3-21: Knockout Holes for Ceiling Mounting Brackets .....	29
Figure 3-22: Installing Ceiling Mounting Bracket (One Side).....	30
Figure 3-23: Ceiling Mounting .....	31



## S19A/S24A-QM87i Marine Panel PC

<b>Figure 3-24: Alternative of Ceiling Mounting Brackets.....</b>	<b>31</b>
<b>Figure 3-25: Serial Port Locations .....</b>	<b>32</b>
<b>Figure 3-26: CAN Bus Connector.....</b>	<b>34</b>
<b>Figure 3-27: CAN Bus Jumper Locations .....</b>	<b>35</b>
<b>Figure 3-28: Power Input Connector Pinouts .....</b>	<b>35</b>
<b>Figure 3-29: Power Connector and Power Button .....</b>	<b>36</b>
<b>Figure 3-30: Clear CMOS Button Location.....</b>	<b>36</b>
<b>Figure 3-31: IEI Resource Download Center.....</b>	<b>37</b>
<b>Figure 3-32: IEI iMAN Web Address.....</b>	<b>40</b>
<b>Figure 3-33: IEI iMAN Web GUI.....</b>	<b>41</b>
<b>Figure 4-1: OSD Button Locations.....</b>	<b>43</b>
<b>Figure 4-2: Image Menu .....</b>	<b>45</b>
<b>Figure 4-3: System Menu .....</b>	<b>46</b>
<b>Figure 6-1: SBOX Computer Retention Screws.....</b>	<b>88</b>
<b>Figure 6-2: Bottom Cover Retention Screws .....</b>	<b>89</b>
<b>Figure 6-3: SO-DIMM Locations .....</b>	<b>89</b>
<b>Figure 6-4: SO-DIMM Installation .....</b>	<b>90</b>
<b>Figure 7-1: Main Board Layout Diagram (Front Side).....</b>	<b>92</b>
<b>Figure 7-2: Main Board Layout Diagram (Solder Side).....</b>	<b>93</b>

# List of Tables

---

Table 1-1: Technical Specifications.....	9
Table 2-1: Package List.....	14
Table 2-2: Optional Items.....	15
Table 3-1: RS-232 Serial Port (COM1) Pinouts .....	33
Table 3-2: RS-232/422/485 Serial Port Pinouts .....	33
Table 3-3: CAN Bus Connector Pinouts.....	34
Table 3-4: CAN Bus Jumper Settings.....	35
Table 4-1: OSD Control Buttons.....	43
Table 4-2: OSD Menus.....	44
Table 5-1: BIOS Navigation Keys .....	50
Table 7-1: Peripheral Interface Connectors .....	95
Table 7-2: Audio Connector (AUDIO1) Pinouts .....	95
Table 7-3: Battery Connector (BAT1) Pinouts .....	95
Table 7-4: Chassis Intrusion Connector (CHASSIS1) Pinouts.....	95
Table 7-5: Digital I/O Connector (DIO1) Pinouts.....	96
Table 7-6: EC Debug Connector (LPT_DB1) Pinouts.....	96
Table 7-7: Fan Connector (CPU_FAN1) Pinouts.....	96
Table 7-8: Front Panel Connector (F_PANEL1) Pinouts.....	97
Table 7-9: IPMI LED Connector (IPMI_LED1) Pinouts.....	97
Table 7-10: LAN Active LED Connector (LAN_ACT_LED1).....	97
Table 7-11: PCIe Mini Slots (MINI-PCIE1, MINI-PCIE2) Pinouts .....	98
Table 7-12: Power Connector (PWR1) Pinouts.....	98
Table 7-13: Power Button Connector (PWR_BTN1) Pinouts.....	99
Table 7-14: PS_ON Connector (PS_ON1) Pinouts.....	99
Table 7-15: RS-232/422/485 Connectors (COM2, COM3, COM4, COM5) .....	99
Table 7-16: SATA Connector (S_ATA1) Pinouts .....	100
Table 7-17: SATA Connector (S_ATA2) Pinouts .....	100
Table 7-18: SATA Power Connector (SATA_PWR1) Pinouts .....	100
Table 7-19: SATA Power Connector (SATA_PWR2) Pinouts .....	101
Table 7-20: SMBus Connector, EC (SMB1) .....	101
Table 7-21: SPI Flash Connector (SPI1) Pinouts .....	101

## S19A/S24A-QM87i Marine Panel PC

Table 7-22: SPI Flash Connector, EC (CN2).....	102
Table 7-23: TPM Connector (TPM1) Pinouts.....	102
Table 7-24: Rear Panel Connectors.....	103
Table 7-25: CAN Bus Connector (CAN1) Pinouts.....	103
Table 7-26: DVI Connector (DVI) Pinouts.....	103
Table 7-27: VGA Connector (VGA1) Pinouts.....	104
Table 7-28: HDMI Connector (HDMI1) Pinouts.....	104
Table 7-29: RJ-45 GbE Connector (LAN1/2-CN1) Pinouts.....	105
Table 7-30: RS-232 Serial Port (COM1) Pinouts.....	105
Table 7-31: USB 2.0 Connector (USB1) Pinouts.....	105
Table 7-32: USB 3.0 Connector (USB3_CN1) Pinouts.....	106

# List of BIOS Menus

---

BIOS Menu 1: Main .....	51
BIOS Menu 2: Advanced .....	52
BIOS Menu 3: ACPI Configuration .....	53
BIOS Menu 4: RTC Wake Settings .....	54
BIOS Menu 5: Trusted Computing .....	55
BIOS Menu 6: CPU Configuration .....	56
BIOS Menu 7: SATA Configuration .....	59
BIOS Menu 8: Intel Rapid Start Technology .....	60
BIOS Menu 9: AMT Configuration .....	61
BIOS Menu 10: USB Configuration .....	62
BIOS Menu 11: iWDD H/W Monitor .....	63
BIOS Menu 12: F81866 Super IO Configuration .....	64
BIOS Menu 13: Serial Port n Configuration Menu .....	65
BIOS Menu 14: Serial Port Console Redirection .....	71
BIOS Menu 15: IEI Feature .....	72
BIOS Menu 16: Chipset .....	73
BIOS Menu 17: PCH-IO Configuration .....	73
BIOS Menu 18: System Agent (SA) Configuration .....	75
BIOS Menu 19: Graphics Configuration .....	76
BIOS Menu 20: Memory Configuration .....	78
BIOS Menu 21: Boot .....	78
BIOS Menu 22: Security .....	80
BIOS Menu 23: Save & Exit .....	81
BIOS Menu 24: Server Management .....	82
BIOS Menu 25: System Event Log .....	83
BIOS Menu 26: BMC Network Configuration .....	85

Chapter

1

# Introduction

---

## 1.1 Overview



**Figure 1-1: S19A-QM87i Marine Panel PC**

The S19A/S24A-QM87i series is a 19"/24" marine panel PC with Intel® Core™ i5-4400E processor and Intel® QM87 Express Chipset. The S19A/S24A-QM87i is preinstalled with 4 GB of DDR3 SO-DIMM and can accommodate up to 16 GB of DDR3 memory. Storage in the system is handled by two 2.5" SATA 6Gb/s SSD bays and the CFast card slot.

In addition, the S19A/S24A-QM87i features Intelligent Platform Management Interface 2.0 (IPMI 2.0) that helps lower the overall costs of server management by enabling users to maximize IT resource, save time and manage multiple systems. The S19A/S24A-QM87i supports IPMI 2.0 through the optional iRIS-2400 module.

The S19A/S24A-QM87i has five serial ports, including four isolated RS-232/422/485 serial ports on the front panel and one RS-232 serial port on the rear panel. The HDMI, DVI-D and VGA connectors allow the S19A/S24A-QM87i to support various display devices. Other slots and connectors include half-size and full-size PCIe Mini card slots, isolated CAN bus 2.0B, Gigabit Ethernet, USB 2.0 ports, USB 3.0 ports and audio jacks (line-in, line-out and mic-in).

## 1.2 Features

The S19A/S24A-QM87i has the following features

- 19"/24" screen display with 0 to 100% full range dimming
- Projected capacitive type touchscreen

## S19A/S24A-QM87i Marine Panel PC

- 2.7 GHz Intel® Core™ i5-4400E CPU supported
- Intel® QM87 chipset
- Isolated CAN bus 2.0B supported
- Four isolated RS-232/422/485 serial ports and one RS-232 DB-9 serial ports
- Multiple display interfaces support triple independent display, including one HDMI connector, one DVI-D connector and one VGA connector
- Two 2.5" SATA 6Gb/s SSD bays
- One CFAST card supported
- Two GbE LAN for high speed network applications
- Two USB 3.0 ports and two USB 2.0 ports
- Three audio jacks: line-out, line-in and mic-in
- IP 66 compliant front panel
- Fanless design
- RoHS compliant design

### 1.3 Front Panel

The front side of the S19A/S24A-QM87i (**Figure 1-2**) is a flat panel LCD screen surrounded by an aluminum frame. The bottom frame includes four OSD buttons and an ambient light sensor.

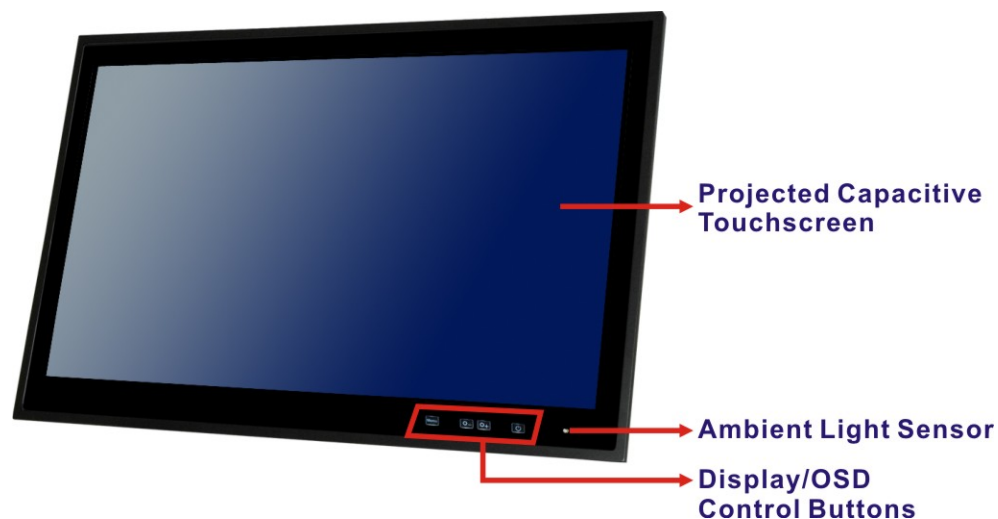

Figure 1-2: S24A-QM87i Front Panel

### 1.3.1 Display Control Buttons

The display control buttons are located on the bottom right corner of the front panel. The function of each button is described in the following diagram. These buttons can also be used to control OSD (on-screen display). Please refer to **Chapter 4** for more detail.

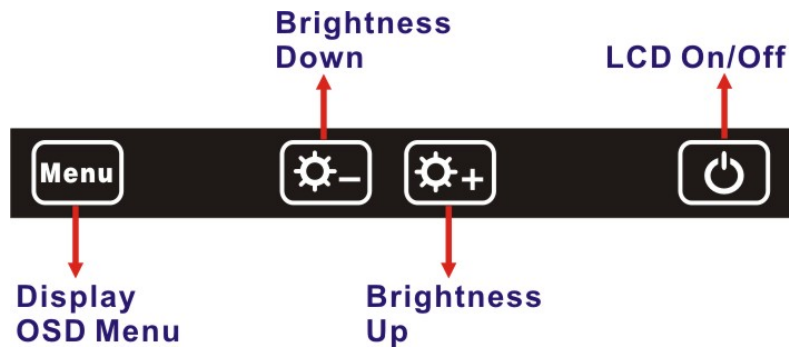

Figure 1-3: Display Control Buttons

### 1.4 Top Panel

The top panel of the S19A/S24A-QM87i provides access to the following external I/O connectors and LED indicators:

- 4 x Isolated RS-232/422/485 serial port
- 1 x Power LED indicator (on: green; off: amber)
- 1 x HDD/CFast card LED indicator (active: blinking in red)
- 1 x IPMI LED indicator (enabled: blue; disabled: off)
- 2 x Knockout hole for SMA antenna connector

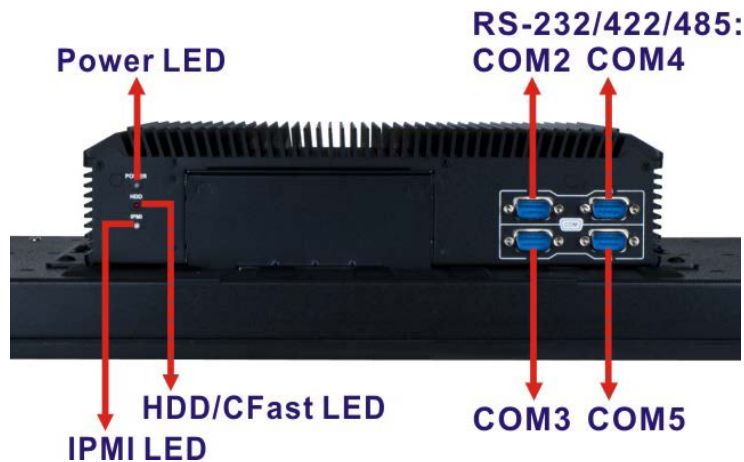

Figure 1-4: Top Panel



## S19A/S24A-QM87i Marine Panel PC



### NOTE:

The default settings for COM2 – COM5 are set to RS-485. To configure the COM port mode, please change the BIOS options in Advanced → F81866 Super IO Configuration → Serial Port Configuration (refer to **Section 5.3.10.1**).

## 1.5 Bottom Panel

The S19A/S24A-QM87i bottom panel provides access to the following external I/O connectors:

- 1 x 18 V – 36 V DC input terminal block
- 1 x Audio line-in jack
- 1 x Audio line-out jack
- 1 x Audio mic-in jack
- 1 x AT/ATX power mode switch
- 1 x CAN bus terminal block
- 1 x CFast card slot
- 1 x Clear CMOS switch
- 1 x DVI-D connector
- 2 x GbE RJ-45 connector
- 1 x HDMI connector
- 1 x Keyboard/Mouse PS/2 connector
- 1 x Power button
- 1 x RS-232 DB-9 serial port
- 2 x USB 2.0 port connector
- 2 x USB 3.0 port connector
- 1 x VGA connector

An overview of the bottom panel is shown in **Figure 1-5** below.

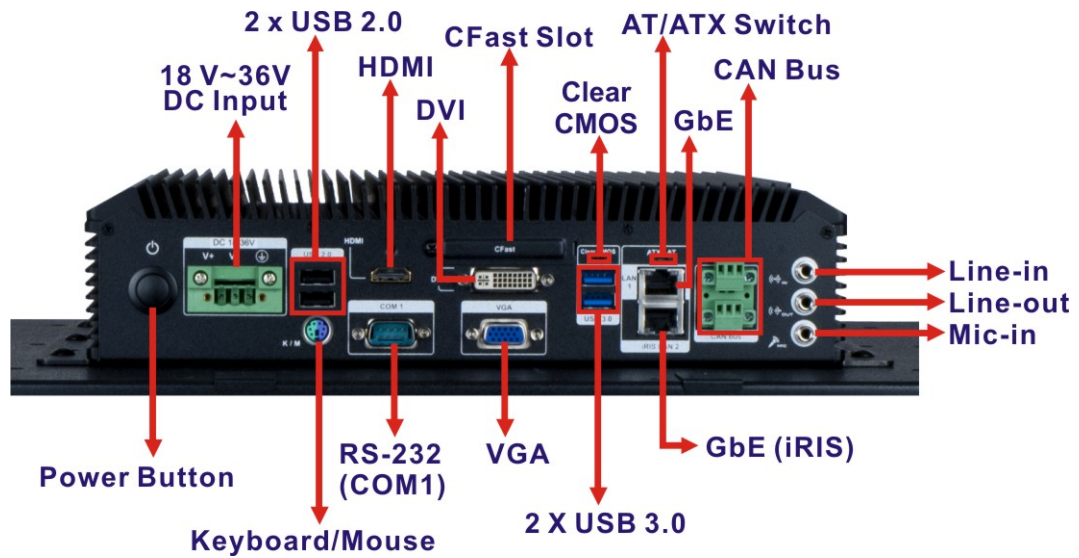

**Figure 1-5: Bottom Panel**

## 1.6 Rear Panel

The rear panel is installed with a SBOX marine computer which can be easily uninstalled from the display panel. In addition, there are some ventilation vents, cable tie holders and several mounting holes for panel mount and stand mount.

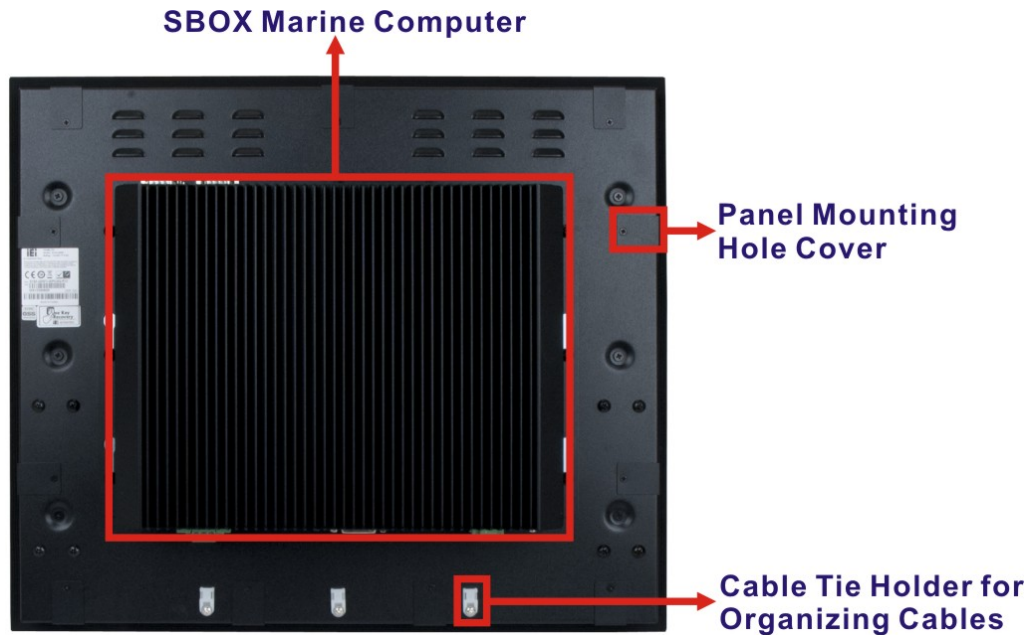

**Figure 1-6: S19A-QM87i Rear Panel**

## S19A/S24A-QM87i Marine Panel PC

### 1.7 Technical Specifications

The specifications for the S19A/S24A-QM87i are listed below.

	S19A-QM87i	S24A-QM87i
<b>LCD Size</b>	19"	24"
<b>Panel Type</b>	PMVA	AMVA
<b>Max. Resolution</b>	1280 x 1024 (5:4)	1920 x 1080 (16:9)
<b>Contrast Ratio</b>	2000:1	5000:1
<b>Brightness (cd/m<sup>2</sup>)</b>	300	300
<b>LCD Color</b>	16.7M	16.7M
<b>Pixel Pitch (um)</b>	294 x 294	276.75 x 276.75
<b>Viewing Angles (H-V)</b>	178 / 178	178 / 178
<b>Backlight MTBF (HRs)</b>	50,000	50,000
<b>Touch Controller</b>	PCAP Touch EXC3188 (10-point)	PCAP Touch EXC3188 (10-point)
<b>Touchscreen</b>	Projected capacitive type touchscreen	
<b>CPU</b>	22nm 4th generation dual-core Intel® Core™ i5-4400E CPU (2.7GHz, 3M cache)	
<b>System Chipset</b>	Intel® QM87 Express Chipset	
<b>System Memory</b>	Two 1600 MHz 2 GB DDR3 SDRAM SO-DIMM preinstalled (system max. 16 GB)	
<b>Ethernet</b>	Two GbE LAN RJ-45 connectors with teaming support and 2 kV isolation protection:  LAN1: Intel® I217-LM with Intel® AMT 9.0 support  LAN2: Intel® I210-AT Ethernet controller	
<b>CAN Bus</b>	1 x CAN bus 2.0B terminal block (6-pin) with 2.5 kV isolation protection	

<b>Display</b>	1 x DVI-D connector 1 x HDMI connector 1 x VGA connector
<b>Serial Port</b>	1 x RS-232 DB-9 serial port (non-isolated) 4 x RS-232/422/485 DB-9 serial port (2.5 kV isolation protection)
<b>USB</b>	2 x USB 2.0 port 2 x USB 3.0 port
<b>Audio</b>	1 x Line-in jack 1 x Line-out jack 1 x Mic-in jack
<b>Keyboard/Mouse</b>	1 x PS/2 connector
<b>Storage</b>	2 x 2.5" SATA 6GB/s SSD bay with RAID 0/1 function 1 x External CFast socket (with a screwed cover)
<b>Expansion Slot</b>	1 x Full-size PCIe Mini slot 1 x Full-size/Half-size PCIe Mini slot 1 x iRIS-2400 (remote management module) slot
<b>LED Indicators</b>	Power (on: green; off: orange) HDD/CFast (active: blinking in red) IPMI (enabled: blue; disabled: off)
<b>Sensor</b>	Ambient light sensor (0% - 100%)
<b>OSD Buttons</b>	Four capacitive sensor buttons (menu, brightness down, brightness up, LCD on/off )
<b>Power Input</b>	Isolated 18 V ~ 36 V, 8-4 A (DNV-GL certified: 24 V, 6 A) via 3-pin terminal block
<b>Power Supply</b>	150 W DC input ATX power supply module preinstalled
<b>Housing</b>	Front aluminum sheet metal
<b>Mounting</b>	Stand, panel mount, ceiling mount
<b>Watchdog Timer</b>	Supporting 1-255 levels for time interval system reset

## S19A/S24A-QM87i Marine Panel PC

<b>Operating Temperature</b>	-15°C ~ 55°C	
<b>Storage Temperature</b>	-20 °C ~ 60°C	
<b>Operating Humidity</b>	5% ~ 95%	
<b>Color</b>	Black	
<b>Weight (Net/Gross)</b>	9.91 kg/13.38 kg	13.03 kg/17.19 kg
<b>Dimensions (W x D x H)</b>	463 mm x 394 mm x 113 mm	592 mm x 374 mm x 113 mm
<b>Operation Vibration</b>	IEC 60945 and DNV 2.4 compliant	
<b>IP Rating</b>	IP 66 compliant front panel IP 22 compliant rear cover	
<b>EMC</b>	CE, FCC	
<b>Safety</b>	DNV, IEC 60945 4th, IACS-E10, IEC 61174 compliant	

**Table 1-1: Technical Specifications**



**NOTE:**

- Auto-dimming function is not covered by DNV-GL certification (the function is disabled by default).
- Touch-screen function is not covered by DNV-GL certification.
- Not connected I/O ports need to be protected by protection caps (the S19A/S24A-QM87i is shipped with all I/O ports protected by caps).

## 1.8 Dimensions

The physical dimensions of the S19A-QM87i are shown in **Figure 1-7**.

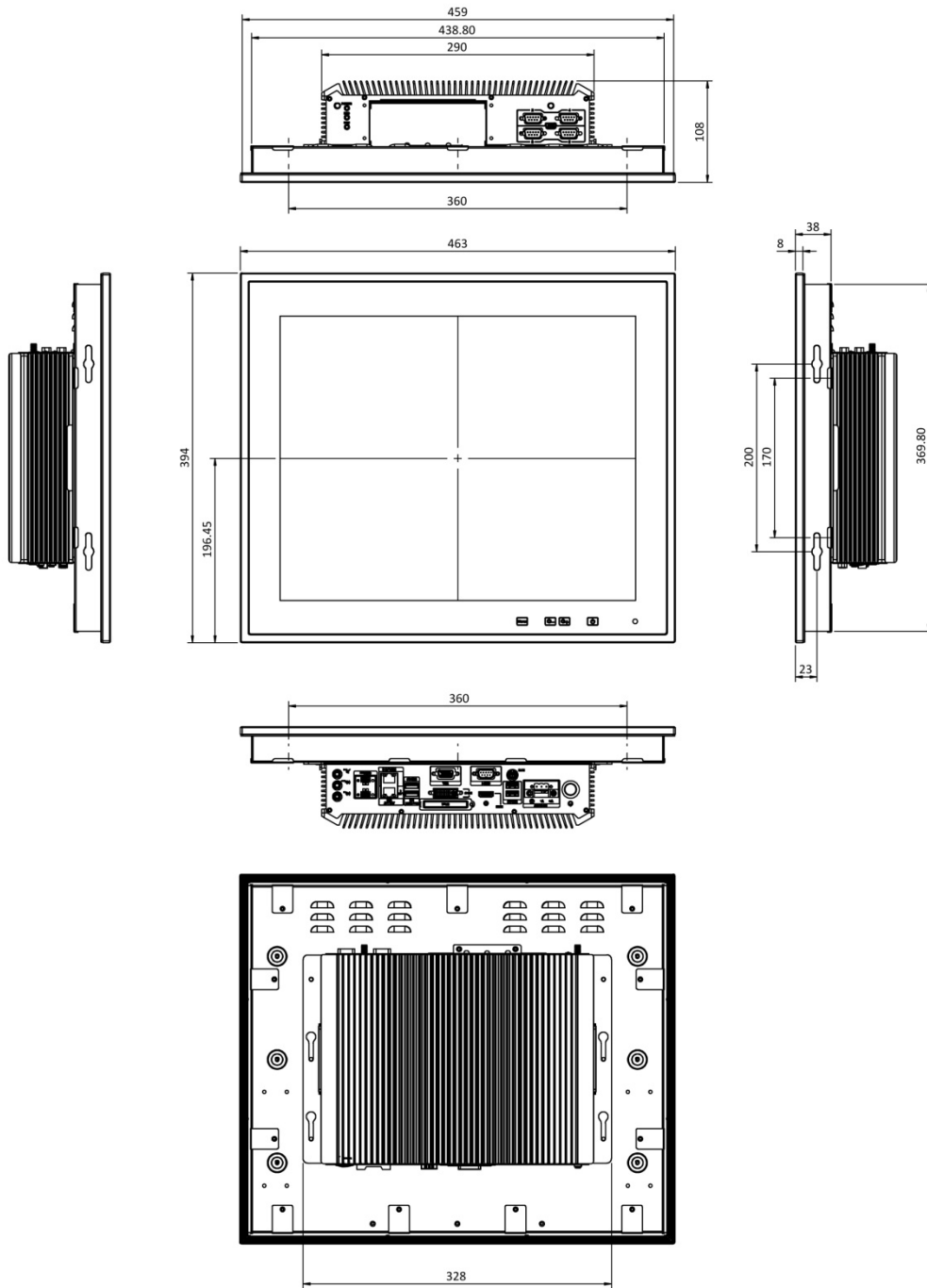

**Figure 1-7: S19A-QM87i Dimensions (mm)**

**S19A/S24A-QM87i Marine Panel PC**

The physical dimensions of the S24A-QM87i are shown in **Figure 1-8**.

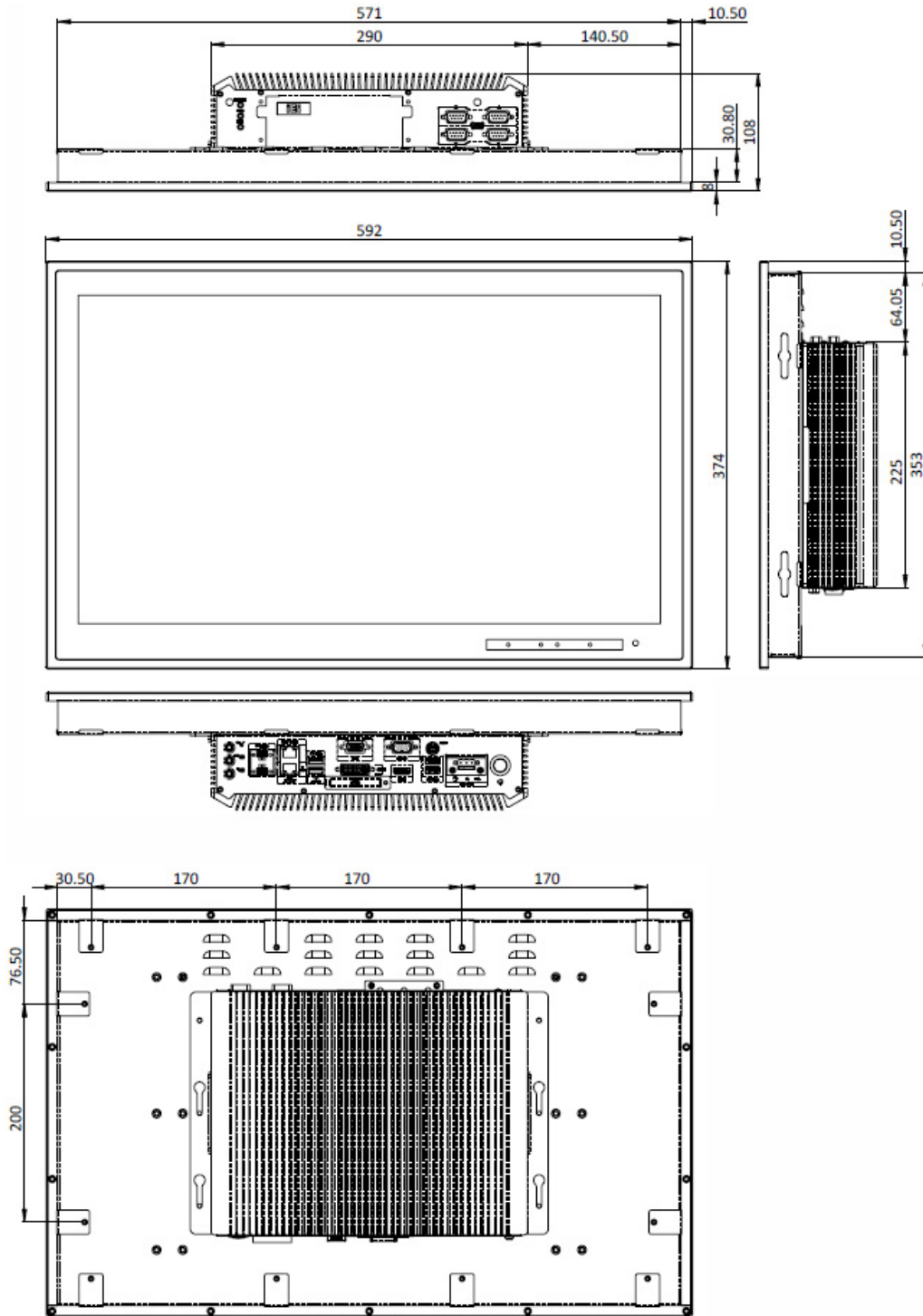

**Figure 1-8: S24A-QM87i Dimensions (mm)**

Chapter

**2**

# Unpacking

---



## S19A/S24A-QM87i Marine Panel PC

### 2.1 Anti-static Precautions

---



#### **WARNING:**

Failure to take ESD precautions during installation may result in permanent damage to the S19A/S24A-QM87i and severe injury to the user.

---

Electrostatic discharge (ESD) can cause serious damage to electronic components, including the S19A/S24A-QM87i. Dry climates are especially susceptible to ESD. It is therefore critical that whenever the S19A/S24A-QM87i or any other electrical component is handled, the following anti-static precautions are strictly adhered to.

- **Wear an anti-static wristband:** Wearing a simple anti-static wristband can help to prevent ESD from damaging the board.
- **Self-grounding:** Before handling the board, touch any grounded conducting material. During the time the board is handled, frequently touch any conducting materials that are connected to the ground.
- **Use an anti-static pad:** When configuring the S19A/S24A-QM87i, place it on an anti-static pad. This reduces the possibility of ESD damaging the S19A/S24A-QM87i.

### 2.2 Unpacking Precautions

When the S19A/S24A-QM87i is unpacked, please do the following:

- Follow the anti-static precautions outlined in **Section 2.1**.
- Make sure the packing box is facing upwards so the S19A/S24A-QM87i does not fall out of the box.
- Make sure all the components shown in **Section 2.3** are present.



## 2.3 Unpacking Checklist



**NOTE:**

If some of the components listed in the checklist below are missing, please do not proceed with the installation. Contact the IEI reseller or vendor you purchased the S19A/S24A-QM87i from or contact an IEI sales representative directly. To contact an IEI sales representative, please send an email to [sales@ieiworld.com](mailto:sales@ieiworld.com).

The S19A/S24A-QM87i is shipped with the following components:

Quantity	Item	Image
1	S19A/S24A-QM87i marine panel PC	
8	Screws (black)	
3	Cable tie	



**Table 2-1: Package List**

## 2.4 Optional Items

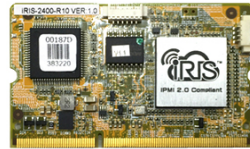
The following are optional components which may be separately purchased:

Item and Part Number	Image
IPMI 2.0 adapter card with AST2400 BMC chip (P/N: iRIS-2400-R10)	

**S19A/S24A-QM87i Marine Panel PC**

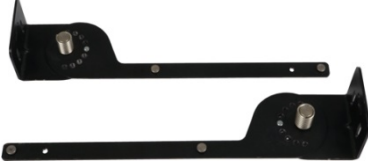
Item and Part Number	Image
Panel mounting kit (P/N: PK-S19A-R10) (P/N: PK-S24A-R10)	
Desktop stand kit (P/N: STAND-S24A-R10)	
Desktop stand (DNV-GL certified)	
Ceiling mounting kit (P/N: CEILMT-S24A-R10)	

**Table 2-2: Optional Items**

Chapter

**3**

# Installation

---

## S19A/S24A-QM87i Marine Panel PC

### 3.1 Installation Precautions

During installation, be aware of the precautions below:

- **Read the user manual:** The user manual provides a complete description of the S19A/S24A-QM87i, installation instructions and configuration options.
- **DANGER! Disconnect Power:** Power to the S19A/S24A-QM87i must be disconnected during the installation process, or before any attempt is made to access the rear panel. Electric shock and personal injury might occur if the rear panel of the S19A/S24A-QM87i is opened while the power cord is still connected to an electrical outlet.
- **Qualified Personnel:** The S19A/S24A-QM87i must be installed and operated only by trained and qualified personnel. Maintenance, upgrades, or repairs may only be carried out by qualified personnel who are familiar with the associated dangers.
- **Air Circulation:** Make sure there is sufficient air circulation when installing the S19A/S24A-QM87i. The S19A/S24A-QM87i's cooling vents must not be obstructed by any objects. Blocking the vents can cause overheating of the S19A/S24A-QM87i. Leave at least 5 cm of clearance around the S19A/S24A-QM87i to prevent overheating.
- **Grounding:** The S19A/S24A-QM87i should be properly grounded. The voltage feeds must not be overloaded. Adjust the cabling and provide external overcharge protection per the electrical values indicated on the label attached to the back of the S19A/S24A-QM87i.

#### 3.1.1 High Surface Temperature



#### **WARNING:**

Some surfaces of the equipment may become hot during operation.

The surface temperature may be up to several tens of degrees hotter than the ambient temperature. Under these circumstances, the equipment needs to be protected against accidental contact.

---

The equipment is intended for installation in a RESTRICTED ACCESS LOCATION.

- Access can only be gained by SERVICE PERSONS or by USERS who have been instructed about the reasons for the restrictions applied to the location and about any precautions that shall be taken.
- Access is through the use of a TOOL or lock and key, or other means of security, and is controlled by the authority responsible for the location.

### 3.2 CFast Card Installation

The S19A/S24A-QM87i series has a CFast card slot on the rear panel. To install the CFast card into the system, please follow the steps below.

**Step 1:** Locate the CFast card slot on the rear panel. Remove the CFast slot cover retention screw on the rear panel (**Figure 3-1**).



**Figure 3-1: CFast Slot Cover Retention Screw**

**Step 2:** Remove the slot cover and insert a CFast card into the slot. (**Figure 3-2**)



**Figure 3-2: CFast Card Installation**

## S19A/S24A-QM87i Marine Panel PC

**Step 3:** Secure the CFast card with the slot cover by fastening the previously removed retention screw.

### 3.3 HDD Installation

The S19A/S24A-QM87i has two 2.5" HDD bays inside the SBOX computer, which is attached to the rear panel of the system. To install HDDs, follow the steps below.

**Step 1:** Remove the SBOX computer from the S19A/S24A-QM87i rear panel by removing/loosing the six retention screws indicated in **Figure 3-3**. Slide the SBOX computer downward and lift the SBOX.

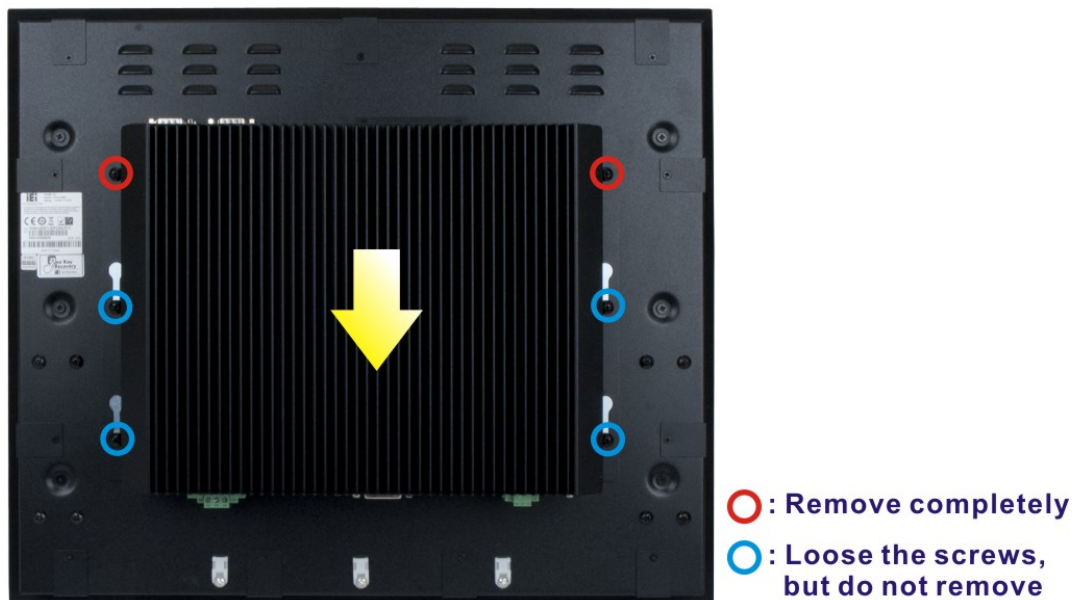

**Figure 3-3: SBOX Computer Retention Screws**



#### **WARNING:**

Please do not completely remove the four screws circled in blue in the above diagram. Doing so may cause damage to the system when re-installing the SBOX computer.

**Step 2:** Remove the bottom cover of the SBOX by removing the 11 retention screws on the bottom panel. See **Figure 3-4**.



**Figure 3-4: Bottom Cover Retention Screws**

**Step 3:** Locate the HDD brackets inside the bottom cover. Remove the four HDD bracket retention screws of one of the HDD brackets and lift the HDD bracket.

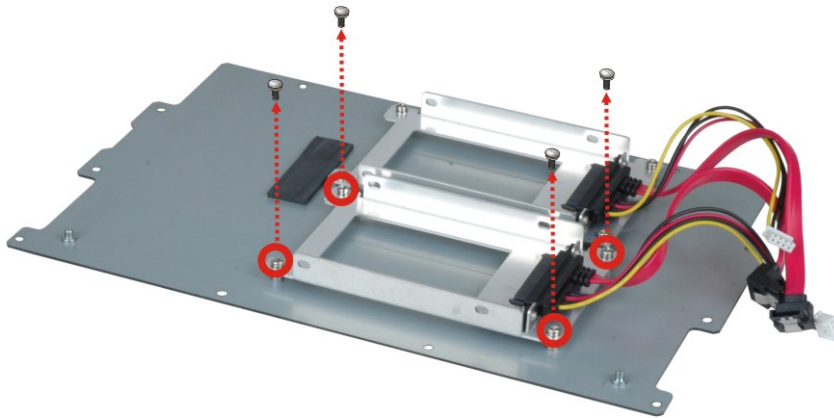
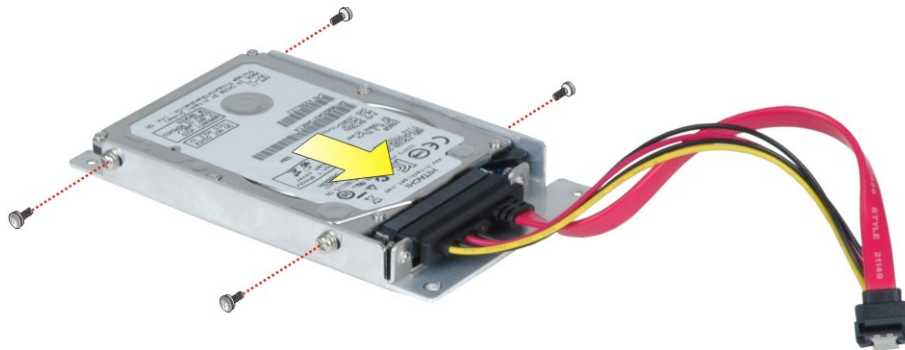

**Figure 3-5: HDD Bracket Retention Screws**

**Step 4:** Insert an HDD into the bracket until the HDD is firmly connected with the SATA cable connector. Secure the HDD to the bracket using four retention screws (two screws on each side). See **Figure 3-6**.



## S19A/S24A-QM87i Marine Panel PC



**Figure 3-6: Inserting the HDD**

**Step 5:** Install the HDD bracket in the same position it was before.

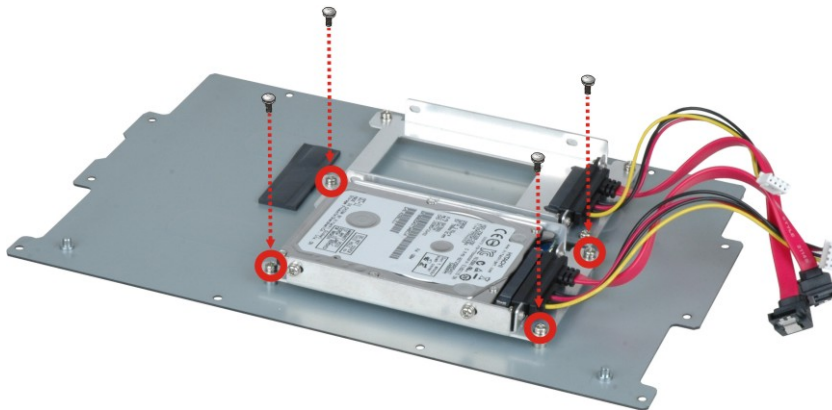

**Figure 3-7: Installing the HDD**

**Step 6:** Repeat the steps described above to install another HDD if necessary.

**Step 7:** Connect the SATA cables and the SATA power cables to the motherboard.

**Step 8:** Reinstall the bottom cover with the previously removed retention screws.

**Step 9:** Reinstall the SBOX computer onto the rear panel of the S19A/S24A-QM87i.

### 3.4 AT/ATX Mode Selection

AT and ATX power modes can both be used on the S19A/S24A-QM87i panel PC. The selection is made through an AT/ATX switch on the I/O interface panel. The switch is shown below.



Figure 3-8: AT/ATX Mode Selection

### 3.5 Mounting the System



#### **WARNING:**

When mounting the S19A/S24A-QM87i flat panel PC onto a panel, it is better to have more than one person to help with the installation to make sure the S19A/S24A-QM87i does not fall down and get damaged.

The following installation options are available:

- Panel mounting
- Stand mounting
- Ceiling mounting

The installation instructions are fully described below. The mounting kits used in the following instructions can be purchased separately. Please contact IEI sales representatives for more detail.

## S19A/S24A-QM87i Marine Panel PC

### 3.5.1 Panel Mounting

To mount the S19A/S24A-QM87i flat panel PC into a panel, please follow the steps below.

**Step 1:** Select the position on the panel to mount the flat panel PC.

**Step 2:** Cut out a section from the panel that corresponds to the rear panel dimensions of the flat panel PC. Take care that the panel section that is cut out is smaller than the overall size of the metal frame that surrounds the flat panel PC but just large enough for the rear panel of the flat panel PC to fit through.

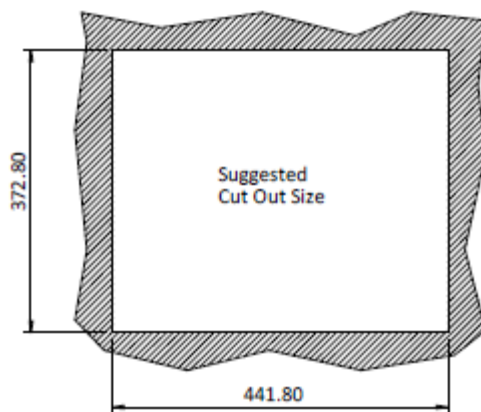

Figure 3-9: S19A-QM87i Cutout Dimensions

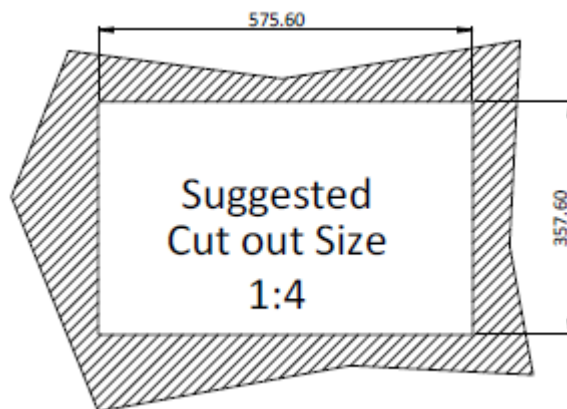
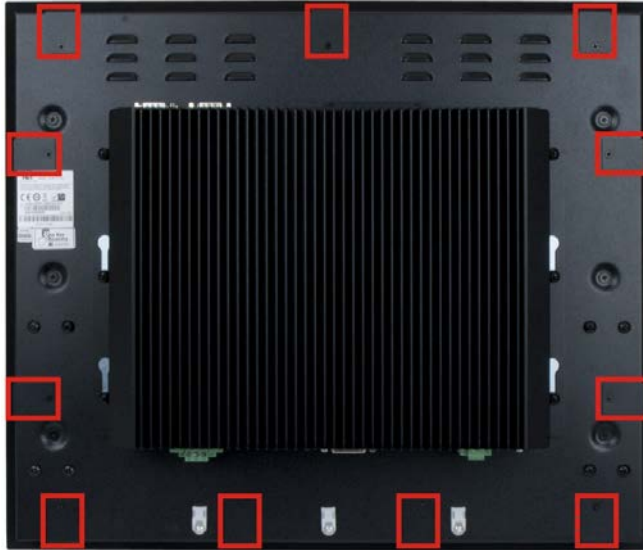

Figure 3-10: S24A-QM87i Cutout Dimensions

**Step 3:** Slide the flat panel PC through the hole until the aluminum frame is flush against the panel.

**Step 4:** Remove the panel mounting hole covers from the rear panel. Each cover is secured to the rear panel with a retention screw. Remove the retention screw to remove the cover.



**Figure 3-11: S19A-QM87i Panel Mounting Hole Covers**

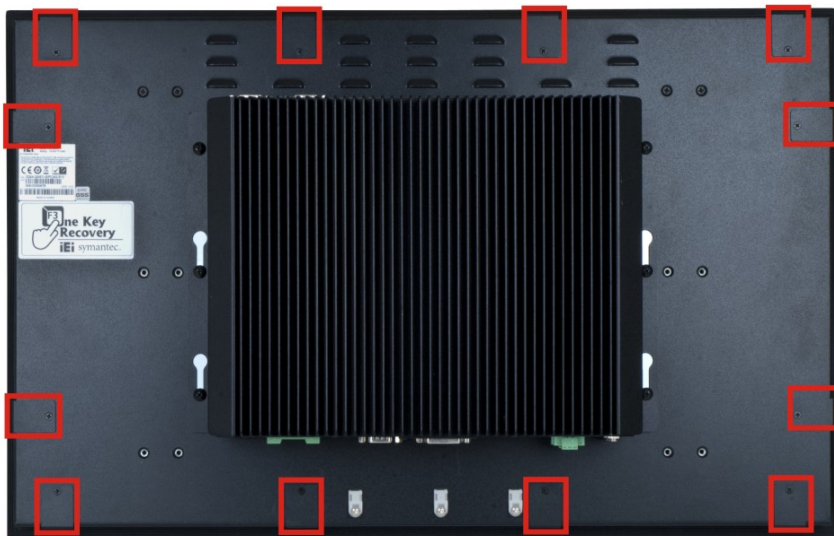

**Figure 3-12: S24A-QM87i Panel Mounting Hole Covers**

**Step 5:** Insert the panel mounting clamps into the pre-formed holes along the edges of the rear panel.

## S19A/S24A-QM87i Marine Panel PC

**Step 6:** Tighten the screws that pass through the panel mounting clamps until the plastic caps at the front of all the screws are firmly secured to the panel (**Figure 3-13**).

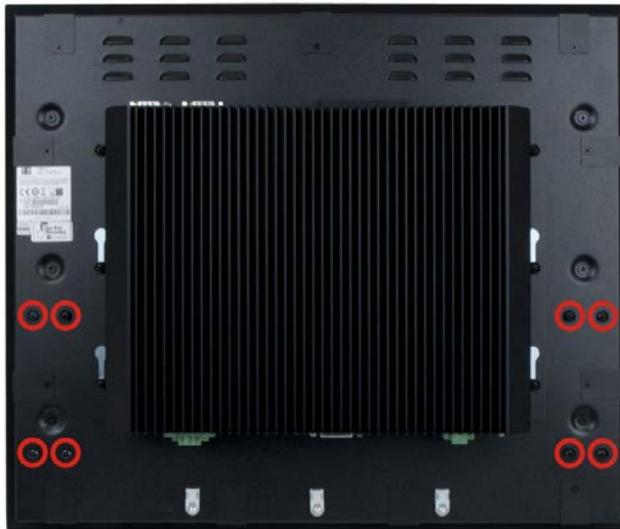

**Figure 3-13: Tighten the Panel Mounting Clamp Screws**

### 3.5.2 Stand Mounting

To mount the S19A/S24A-QM87i using the optional stand mounting kit, please follow the steps below.

**Step 1:** Locate the screw holes on the rear of the S19A/S24A-QM87i. This is where the brackets will be attached.



**Figure 3-14: S19A-QM87i Stand Mounting Screw Holes**

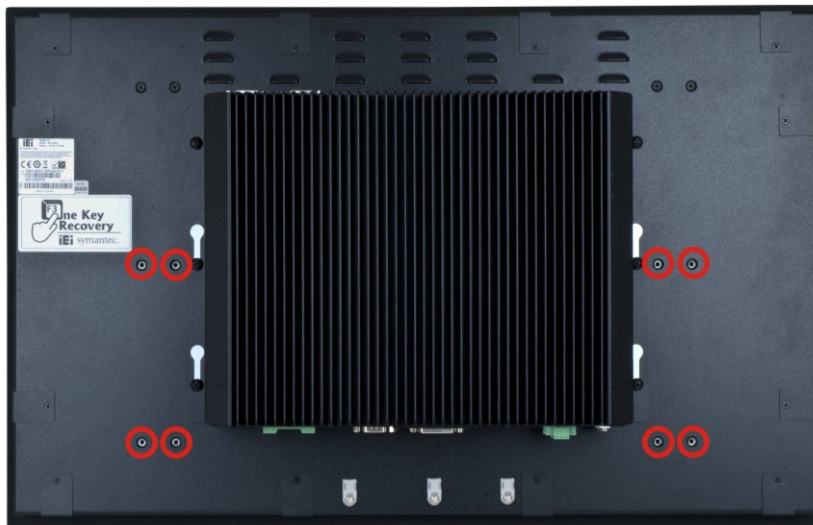

**Figure 3-15: S24A-QM87i Stand Mounting Screw Holes**

- Step 2:** Align the brackets with the screw holes.
- Step 3:** To secure the brackets to the S19A/S24A-QM87i insert the retention screws into the screw holes and tighten them.

## S19A/S24A-QM87i Marine Panel PC

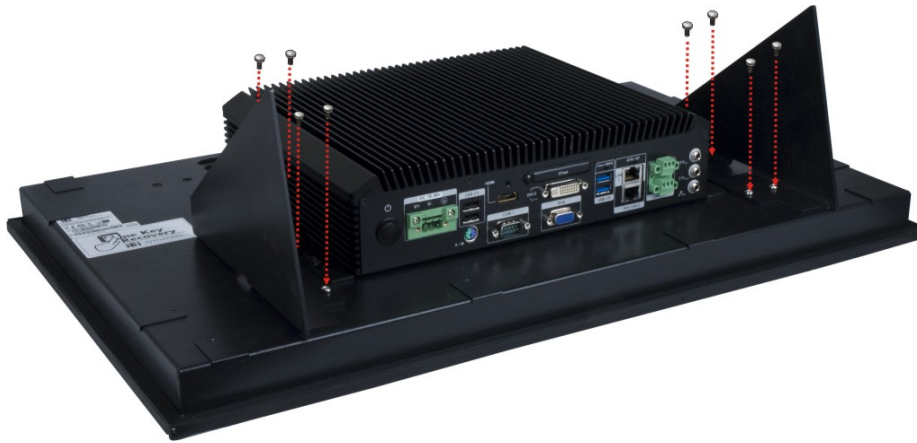

Figure 3-16: Installing Stand

**Step 4:** To display the S19A/S24A-QM87i at a different viewing angle, install the stand mounting kit in the other way.



Figure 3-17: Stand Mounting Method 2

### 3.5.3 Ceiling Mounting

To mount the S19A/S24A-QM87i using the optional ceiling mounting kit, please follow the steps below.

**Step 1:** Select a location on the ceiling for the ceiling mounting brackets.

**Step 2:** Refer to the dimensions listed in the following diagrams to mark the locations of the six bracket screw holes on the ceiling.

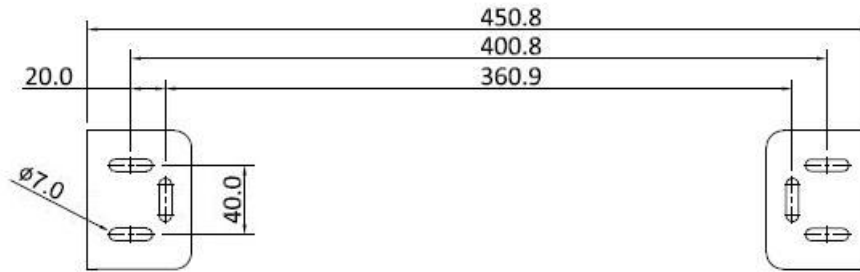

**Figure 3-18: Locations of Bracket Screw Holes for S19A-QM87i**

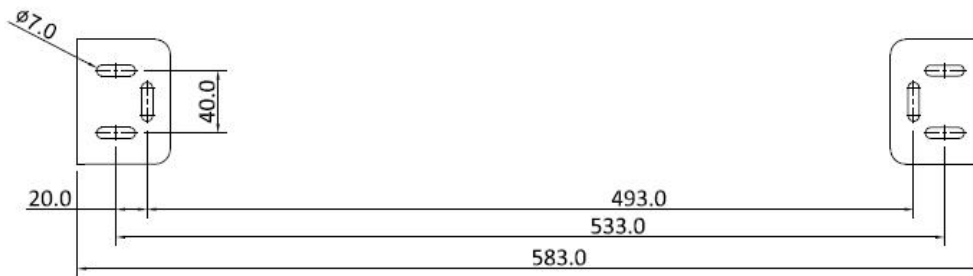

**Figure 3-19: Locations of Bracket Screw Holes for S24A-QM87i**

- Step 3:** Drill six pilot holes at the marked locations on the ceiling for the bracket retention screws.
- Step 4:** Please adjust the ceiling mounting brackets before installation in order to have a proper viewing angle. To adjust the mounting angle, pull out the green screw on the bracket and gently rotate the green screw to temporarily lock the screw in the pull-out position. Then, adjust the bracket to a proper position. When the bracket almost reaches the ideal point, rotate the green screw again to release it. Move the bracket gently until the green screw snap into place.



S19A/S24A-QM87i Marine Panel PC



Figure 3-20: Ceiling Mounting Bracket Adjustment

**Step 5:** Remove the four knockout holes on the side panels (two on each side). See

Figure 3-21.



Figure 3-21: Knockout Holes for Ceiling Mounting Brackets

**Step 6:** Align the rivets on the mounting brackets with the mounting holes on the side panels.

**Step 7:** Carefully insert the rivets through the holes and pull the bracket downwards until the bracket rest securely in the slotted holes. Then, insert a captive screw and tighten it firmly to secure the bracket. See **Figure 3-22**.

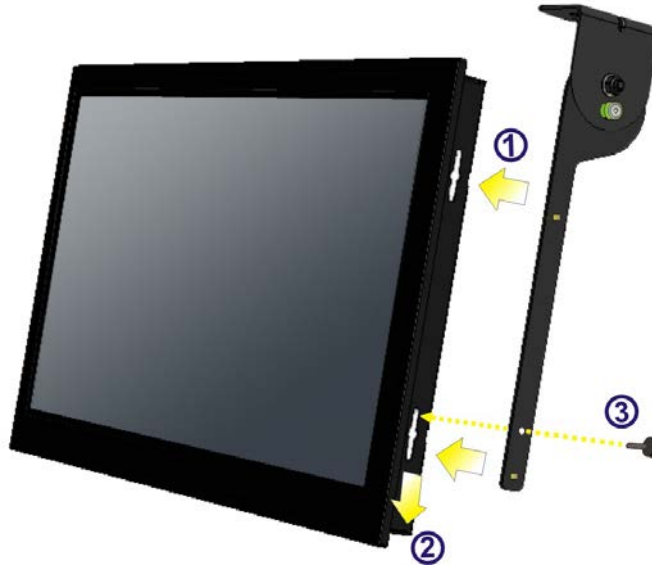

**Figure 3-22: Installing Ceiling Mounting Bracket (One Side)**

- Step 8:** Follow the instruction described above to install the other bracket.
- Step 9:** Align the ceiling mounting bracket screw holes with the pilot holes on the ceiling.
- Step 10:** Secure the ceiling mounting brackets to the ceiling by inserting the retention screws into the six pilot holes and tightening them.

## S19A/S24A-QM87i Marine Panel PC



Figure 3-23: Ceiling Mounting

**Step 11:** The ceiling mounting brackets can also be used to mount on other surfaces. To do so, simply install the brackets the other way around as shown in **Figure 3-24**.



Figure 3-24: Alternative of Ceiling Mounting Brackets

### 3.6 Serial Device Connection

The S19A/S24A-QM87i series has five serial ports, including four RS-232/422/484 ports on the front panel and one RS-232 port on the rear panel. The port locations are shown in **Figure 3-25**. The pinouts of the serial ports are listed in the following sections.

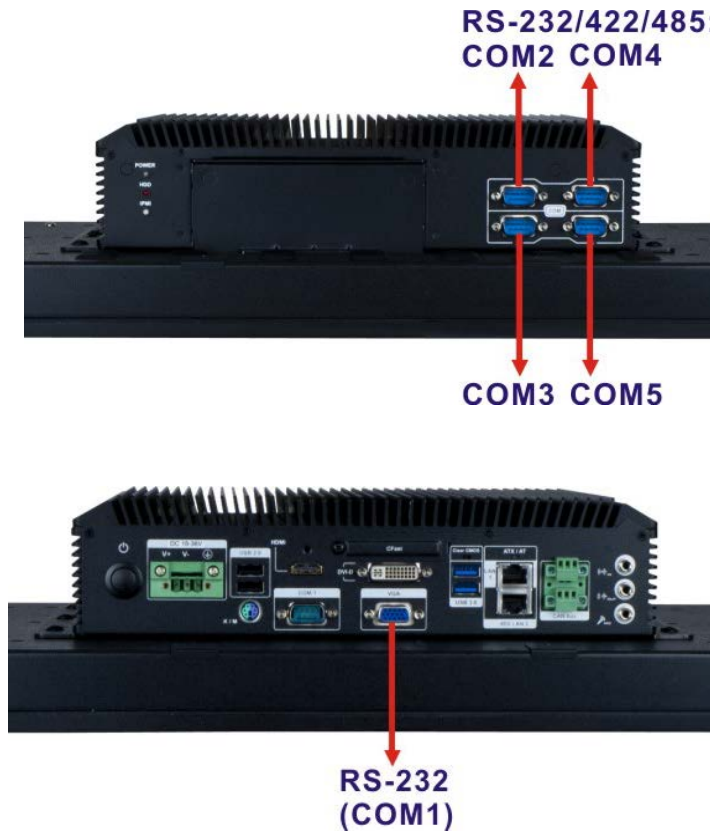

**Figure 3-25: Serial Port Locations**



**NOTE:**

The default settings for COM2 – COM5 are set to RS-485. To configure the COM port mode, please change the BIOS options in Advanced → F81866 Super IO Configuration → Serial Port Configuration (refer to **Section 5.3.10.1**).

## S19A/S24A-QM87i Marine Panel PC

### 3.6.1 RS-232 Serial Port (COM1)

The pinouts of the RS-232 serial port are listed in the following table.

PIN NO.	DESCRIPTION	PIN NO.	DESCRIPTION
1	DCD	2	RXD
3	TXD	4	DTR
5	GND	6	DSR
7	RTS	8	CTS
9	RI		

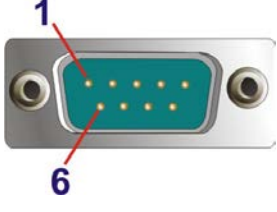

**Table 3-1: RS-232 Serial Port (COM1) Pinouts**

### 3.6.2 RS-232/422/485 Serial Port (COM2–COM5)

The RS-232/422/485 mode selection of COM2 – COM5 is made through the system BIOS. Please refer to **Section 5.3.10.1** for selecting COM port mode. The default setting for COM2 – COM5 is RS-485.

The isolated RS-232/422/485 serial port pinouts are listed in the following table.

PIN NO.	RS-232	RS-422	RS-485 (Default)
1	DCD	TXD422-	TXD485-
2	RXD	TXD422+	TXD485+
3	TXD	RXD422+	--
4	DTR	RXD422-	--
5	GND	--	--
6	DSR	--	--
7	RTS	--	--
8	CTS	--	--
9	RI	--	--



**Table 3-2: RS-232/422/485 Serial Port Pinouts**

### 3.7 CAN Bus Connection and Configuration

The S19A/S24A-QM87i has a CAN bus connector for CAN-bus connection. The pinouts for the CAN bus connector are listed in the figure and table below.

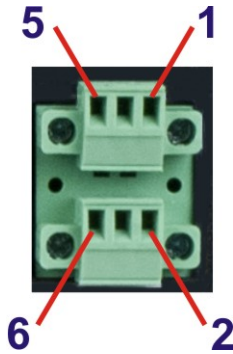

**Figure 3-26: CAN Bus Connector**

PIN NO.	DESCRIPTION	PIN NO.	DESCRIPTION
1	CAN1H	2	CAN2H
3	CAN1L	4	CAN2L
5	GND_CAN1	6	GND_CAN2

**Table 3-3: CAN Bus Connector Pinouts**

The on-board jumpers, JP1 and JP2, can be used for CAN bus configuration. The jumper settings and locations are listed below.

S19A/S24A-QM87i Marine Panel PC

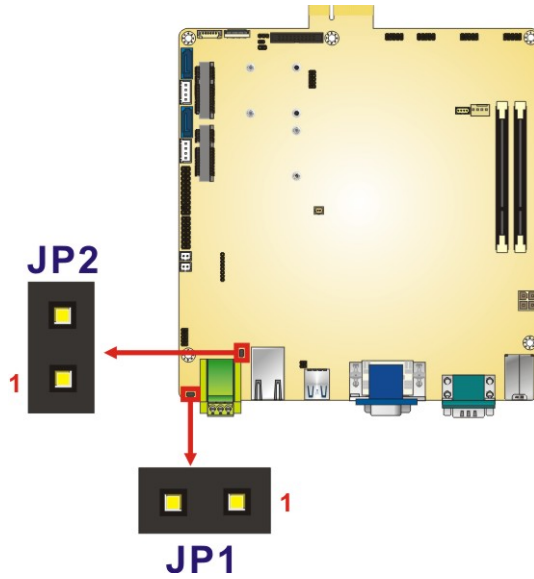

Figure 3-27: CAN Bus Jumper Locations

JP1 & JP2	DESCRIPTION
Short	Long wire transmitting
Open	Normal

Table 3-4: CAN Bus Jumper Settings

### 3.8 Powering On the System

To power on the system, follow the steps below:

**Step 1:** Connect the power cable to the 3-pin power input terminal block.

The pinouts of the power input connectors are shown below.

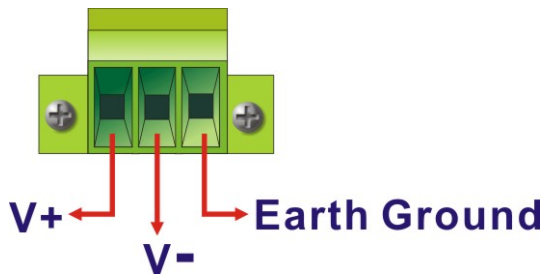
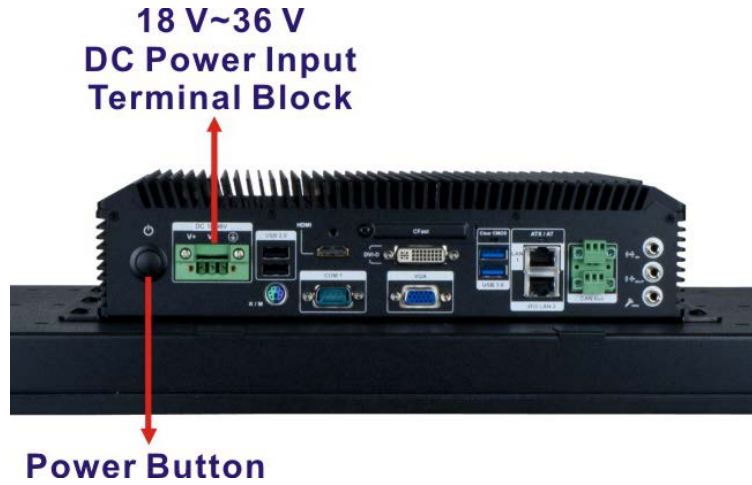

Figure 3-28: Power Input Connector Pinouts

**Step 2:** Push the power button on the I/O panel to power on the system.



**Figure 3-29: Power Connector and Power Button**

### 3.9 Clear CMOS

If the S19A/S24A-QM87i fails to boot due to improper BIOS settings, the clear CMOS button clears the CMOS data and resets the system BIOS information. To do this, push the clear CMOS button for three seconds, and then restart the system. The clear CMOS button location is shown in **Figure 3-30**.



**Figure 3-30: Clear CMOS Button Location**



## S19A/S24A-QM87i Marine Panel PC

### 3.10 Available Drivers

All the drivers for the S19A/S24A-QM87i are available on IEI Resource Download Center (<https://download.ieiworld.com>). Type S19A/S24A-QM87i and press Enter to find all the relevant software, utilities, and documentation.



Figure 3-31: IEI Resource Download Center

IEI provides the following drivers for Windows 7 and Windows 8 operating systems.

- Chipset
- Graphics
- LAN
- Audio
- CAN bus
- ME
- USB 3.0 (Windows 7 only)

#### 3.10.1 Driver Download

To download drivers from IEI Resource Download Center, follow the steps below.

**Step 1:** Go to <https://download.ieiworld.com>. Type S19A/S24A-QM87i and press Enter.



**Step 2:** All product-related software, utilities, and documentation will be listed. You can choose **Driver** to filter the result.

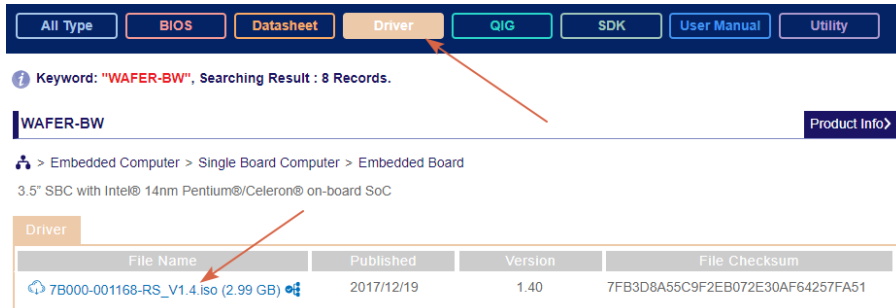

**Step 3:** Click the driver file name on the page and you will be prompted with the following window. You can download the entire ISO file (1), or click the small arrow to find an individual driver and click the file name to download (2).

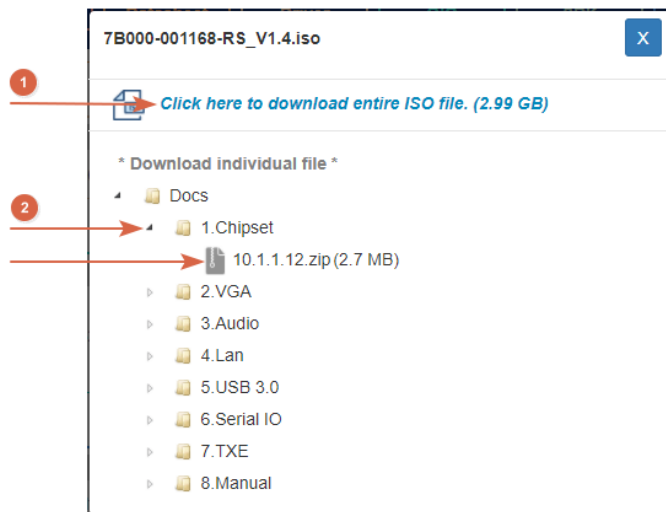

## S19A/S24A-QM87i Marine Panel PC



### NOTE:

To install software from the downloaded ISO image file in Windows 8, 8.1 or 10, double-click the ISO file to mount it as a virtual drive to view its content. On Windows 7 system, an additional tool (such as Virtual CD-ROM Control Panel from Microsoft) is needed to mount the file.

## 3.11 IPMI Setup Procedure

The S19A/S24A-QM87i with iRIS-2400 module installed features Intelligent Platform Management Interface (IPMI) that helps lower the overall costs of server management by enabling users to maximize IT resources, save time and manage multiple systems. The S19A/S24A-QM87i supports IPMI 2.0 through the optional iRIS-2400 module. Follow the steps below to setup IPMI.

### 3.11.1 Managed System Hardware Setup

The hardware configuration of the managed system (S19A/S24A-QM87i) is described below.

- Step 1:** Make sure the S19A/S24A-QM87i is installed with an iRIS-2400 module.
- Step 2:** Make sure at least one DDR3 SO-DIMM is installed in one of the SO-DIMM sockets. If multiple SO-DIMMs are installed, all of the SO-DIMMs must be same size, same speed and same brand to get the best performance.
- Step 3:** Connect an Ethernet cable to the RJ-45 LAN 2 port with iRIS label on the rear panel (**Figure 1-5**).

### 3.11.2 Using the IEI iMAN Web GUI

To manage a client system from a remote console using IEI iMAN Web GUI, follow the steps below.

**Step 1:** Obtain the IP address of the managed system. It is recommended to use the IPMI Tool on the managed system to obtain the IP address. To use IPMI Tool to obtain IP address, follow the steps below:

- a. Copy the **ipmitool.exe** file to a bootable USB flash drive.
- b. Insert the USB flash drive to the S19A/S24A-QM87i
- c. The S19A/S24A-QM87i boots from the USB flash drive
- d. Enter the following command: **ipmitool 20 30 02 01 03 00 00**  
(there is a space between each two-digit number)
- e. A serial of number shows. The last four two-digit hexadecimal numbers are the IP address. Convert the hexadecimal numbers to decimal numbers.

**Step 2:** On the remote management console, open a web browser. Enter the managed system IP address in the web browser (**Figure 3-32**).

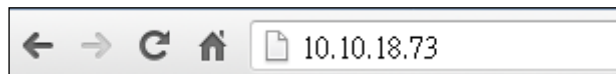

**Figure 3-32: IEI iMAN Web Address**

**Step 3:** The login page appears in the web browser.

**Step 4:** Enter the user name and password to login the system. The default login username and password are:

-Username: **admin**

-Password: **admin**

**Step 5:** Press the login button to login the system.

**Step 6:** The IEI iMAN Web Interface appears. **Step 0:**

S19A/S24A-QM87i Marine Panel PC

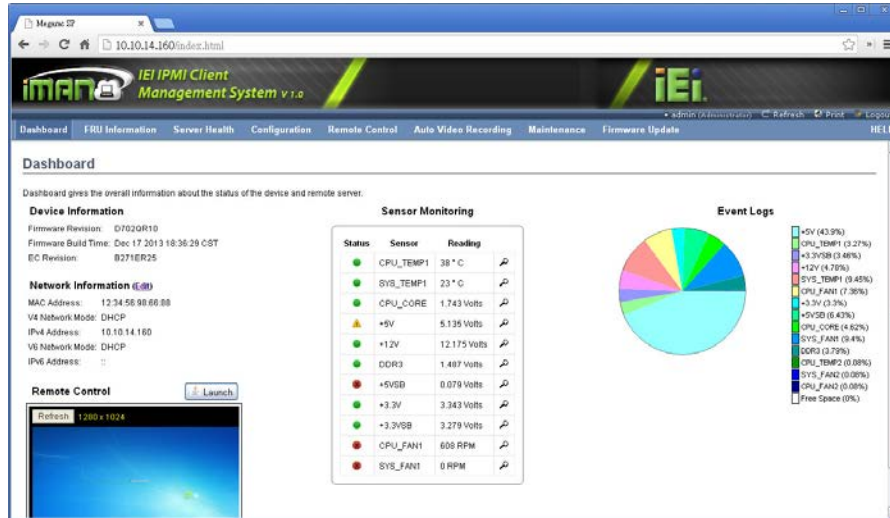

Figure 3-33: IEI iMAN Web GUI



**NOTE:**

To understand how to use the IEI iMAN Web GUI, please refer to the iRIS-2400 Web GUI user manual which can be downloaded from IEI Resource Download Center. The user manual describes each function in detail.

Chapter

**4**

# **On-Screen-Display (OSD) Controls**

---

## S19A/S24A-QM87i Marine Panel PC

### 4.1 User Mode OSD Structure

#### 4.1.1 OSD Buttons

The OSD control buttons are located on the bottom right corner of the front panel.



Figure 4-1: OSD Button Locations

The function of each button is described in the following table.



	<p>Press this button to open the OSD window. When inside a menu, press this button to scroll down or to switch from one selected item to another.</p>
	<p>Press this button to confirm the selection of the item, decrease the value, or to switch from one selected item to another.</p>
	<p>Press this button to confirm the selection of the item, scroll to the right, to increase the value, or to switch from one selected item to another.</p>
	<p>Press this button to exit the main menu or the current menu.</p>

Table 4-1: OSD Control Buttons

### 4.1.2 OSD Menu Structure

Table 4-2 shows the OSD menu structure for all models of the S19A/S24A-QM87i series panel PC.

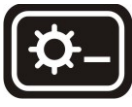
Level 0	Level 1	Value		
Image Menu	Backlight	0 to 100		
	Brightness	0 to 100		
	Contrast	0 to 100		
	Sharpness	0 to 100		
	Color	4200k, 5000k, 6500k, 7500k, 9300k, User, Reset		
System Menu	OSD Settings	Timer	5, 10, 15, 20, 25, 30, 35, 40, 45, 50, 55, 60	
		Rotation	0°, 90°, 180°, 270°	
		Position	0 to 100	
		Transparency	0 to 100	
		Keypad LED 1*	0 to 100	
		Keypad LED 2**	0 to 100	
	Reset	Select		
	Update	Select		
	Misc.	Auto-Dimming	On, Off	
		Gamma	On, Off	
* Control the brightness of the physical OSD buttons when OSD menu is off				
** Control the brightness of the physical OSD buttons when OSD menu is on				

**Table 4-2: OSD Menus**



## S19A/S24A-QM87i Marine Panel PC

### 4.2 Using the OSD

OSD menu options are described below.

#### 4.2.1 Image Menu

Image menu options are shown in **Figure 4-2**.

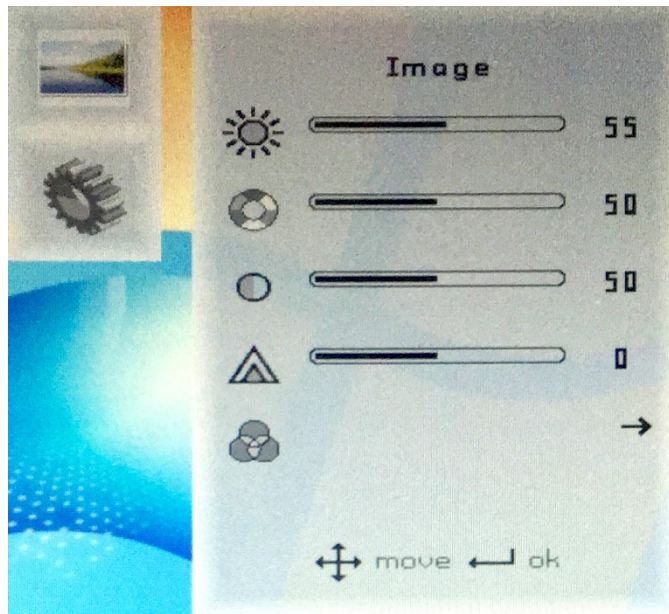

**Figure 4-2: Image Menu**

- |                   |                                                                                                                                                                                                  |
|-------------------|--------------------------------------------------------------------------------------------------------------------------------------------------------------------------------------------------|
| <b>Backlight</b>  | Adjusts the backlight brightness of screen.                                                                                                                                                      |
| <b>Brightness</b> | Adjusts the brightness of screen. Setting this value too high or too low will affect the quality of image. When the auto dimming function is turned on, the brightness control is not effective. |
| <b>Contrast</b>   | Adjusts the gain value of ADC. Adjusting this value too high or too low will worsen the quality of image.                                                                                        |
| <b>Sharpness</b>  | Adjusts the sharpness level. This option may help reduce the softening edges around the displayed objects.                                                                                       |

**Color** Fine-tunes the palette of color hues

### 4.2.2 System Menu

System options are shown in **Figure 4-3**.

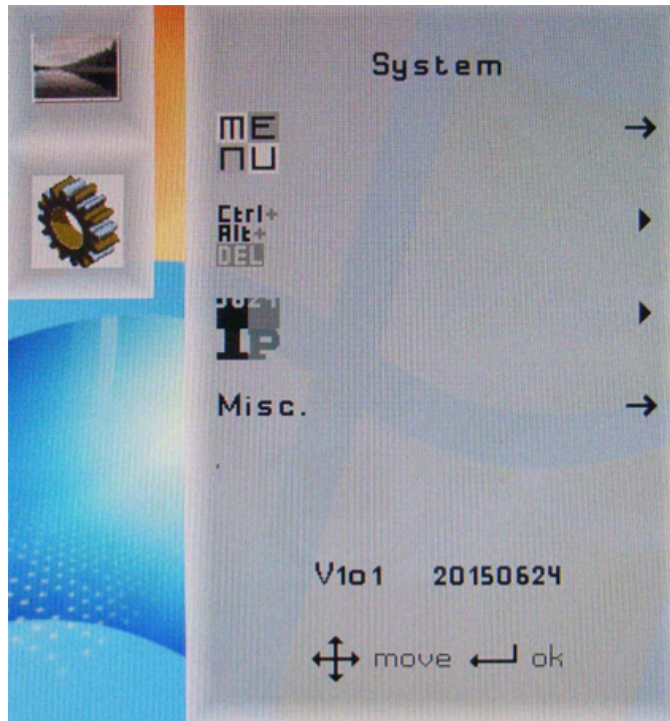

**Figure 4-3: System Menu**

**OSD Settings** This item allows adjustment of the following items:

- **Timer** - Determines how many seconds the OSD menu stays on screen before it disappears when OSD is left unattended.
- **Rotation** - Rotates the OSD menu
- **Position** - Adjusts the horizontal and vertical position of the OSD menu on the screen.
- **Transparency** - Adjusts the transparency of the OSD menu.
- **Keypad LED 1** - Control the brightness of the physical

## S19A/S24A-QM87i Marine Panel PC

OSD buttons when OSD menu is off

- **Keypad LED 2** - Control the brightness of the physical OSD buttons when OSD menu is on

<b>Reset</b>	Restores the default OSD settings. Note that this will restore all default display settings.
<b>Update</b>	Updates the firmware of the system.
<b>Misc.</b>	Provides options to enable or disable auto-brightness (auto-dimming) and gamma.

Chapter

**5**

# BIOS Setup

---

## S19A/S24A-QM87i Marine Panel PC

### 5.1 Introduction

The BIOS is programmed onto the BIOS chip. The BIOS setup program allows changes to certain system settings. This chapter outlines the options that can be changed.



#### NOTE:

Some of the BIOS options may vary throughout the life cycle of the product and are subject to change without prior notice.

#### 5.1.1 Starting Setup

The UEFI BIOS is activated when the computer is turned on. The setup program can be activated in one of two ways.

1. Press the **DEL** or **F2** key as soon as the system is turned on or
2. Press the **DEL** or **F2** key when the “**Press DEL or F2 to enter SETUP**” message appears on the screen.

If the message disappears before the **DEL** or **F2** key is pressed, restart the computer and try again.

#### 5.1.2 Using Setup

Use the arrow keys to highlight items, press **ENTER** to select, use the PageUp and PageDown keys to change entries, press **F1** for help and press **ESC** to quit. Navigation keys are described in the following table.

Key	Function
Up arrow	Move to previous item
Down arrow	Move to next item
Left arrow	Move to the item on the left hand side
Right arrow	Move to the item on the right hand side
+	Increase the numeric value or make changes

Key	Function
-	Decrease the numeric value or make changes
Page Up key	Increase the numeric value or make changes
Page Dn key	Decrease the numeric value or make changes
Esc key	Main Menu – Quit and not save changes into CMOS Status Page Setup Menu and Option Page Setup Menu -- Exit current page and return to Main Menu
F1	General help, only for Status Page Setup Menu and Option Page Setup Menu
F2	Previous values
F3	Load optimized defaults
F4	Save changes and Exit BIOS

**Table 5-1: BIOS Navigation Keys**

### 5.1.3 Getting Help

When **F1** is pressed a small help window describing the appropriate keys to use and the possible selections for the highlighted item appears. To exit the Help Window press **Esc** or the **F1** key again.

### 5.1.4 BIOS Menu Bar

The **menu bar** on top of the BIOS screen has the following main items:

- Main – Changes the basic system configuration.
- Advanced – Changes the advanced system settings.
- Chipset – Changes the chipset settings.
- Boot – Changes the system boot configuration.
- Security – Sets User and Supervisor Passwords.
- Save & Exit – Selects exit options and loads default settings
- Server Mgmt – Changes BMC network configuration.

The following sections completely describe the configuration options found in the menu items at the top of the BIOS screen and listed above.

## S19A/S24A-QM87i Marine Panel PC

### 5.2 Main

The **Main** BIOS menu (**BIOS Menu 1**) appears when the **BIOS Setup** program is entered.

The **Main** menu gives an overview of the basic system information.

Aptio Setup Utility - Copyright (C) 2012 American Megatrends, Inc.						
Main	Advanced	Chipset	Boot	Security	Save & Exit	Server Mgmt
BIOS Information					Set the Date. Use Tab to switch between Data elements.	
BIOS Vendor	American Megatrends					
Core Version	4.6.5.4					
Compliancy	UEFI 2.3.1; PI 1.2					
Project Version	H772AR12.ROM					
Build Date	01/08/2015 13:58:19					
iWDD Vender		iEi				
iWDD Version		H772ER10.bin				
IPMI Module		N/A				
Processor Information						
Name		Haswell				
Brand String		Intel(R)Core(TM) i5-440				
Frequency		3200 MHz				
Processor ID		306c3				
Stepping		C0				
Number of Processors		2Core(S)/4Thread(s)				
Microcode Revision		1c				
GT Info		GT2 (800 MHz)				
IGF VBIOS Version		2167				
Memory RC Version		1.6.2.1				
Total Memory		4096 MB (DDR3)				
Memory Frequency		1600 Mhz			-----	
PCH Information						
Name		LynxPoint			←→: Select Screen	
PCH SKU		QM87			↑ ↓: Select Item	
Stepping		05/C2			EnterSelect	
LAN PHY Revision		A3			+ - Change Opt.	
ME FW Version		9.1.10.1005			F1 General Help	
ME Firmware SKU		5MB			F2 Previous Values	
SPI Clock Frequency					F3 Optimized Defaults	
D0FR Support		Unsupported			F4 Save & Exit	
Read Status Clock Frequency		50 MHz			ESC Exit	
Write Status Clock Frequency		50 MHz				
Fast Read Status Clock Frequency		50 MHz				
Version 2.15.1236. Copyright (C) 2012 American Megatrends, Inc.						

**BIOS Menu 1: Main**

The System Overview field has two user configurable fields:

➔ **System Date [xx/xx/xx]**

Use the **System Date** option to set the system date. Manually enter the day, month and year.

➔ **System Time [xx:xx:xx]**

Use the **System Time** option to set the system time. Manually enter the hours, minutes and seconds.

### 5.3 Advanced

Use the **Advanced** menu (**BIOS Menu 2**) to configure the CPU and peripheral devices through the following sub-menus:



**WARNING!**

Setting the wrong values in the sections below may cause the system to malfunction. Make sure that the settings made are compatible with the hardware.

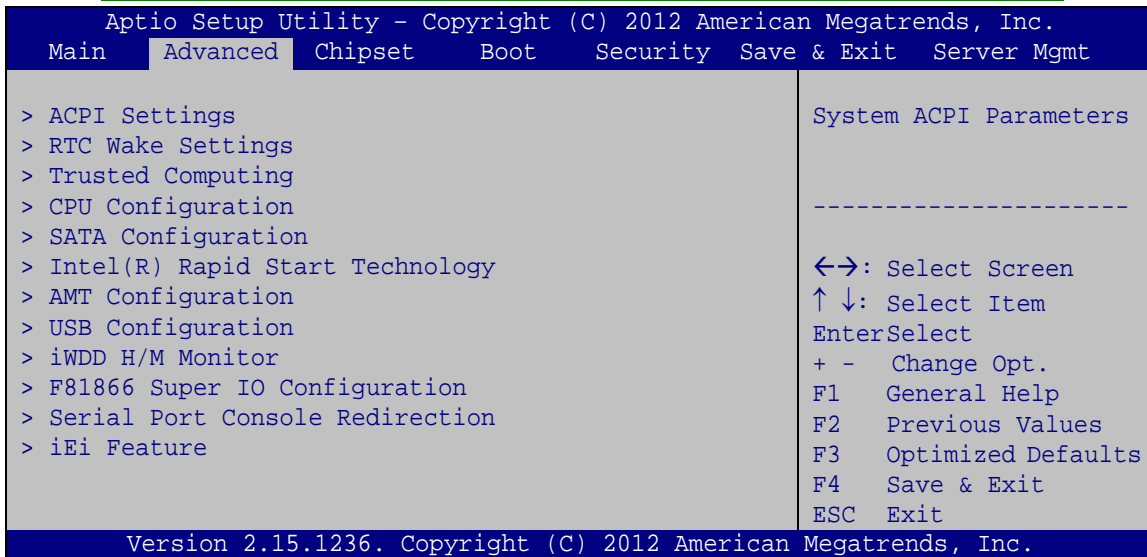

**BIOS Menu 2: Advanced**



## S19A/S24A-QM87i Marine Panel PC

### 5.3.1 ACPI Settings

The **ACPI Settings** menu (**BIOS Menu 3**) configures the Advanced Configuration and Power Interface (ACPI) options.

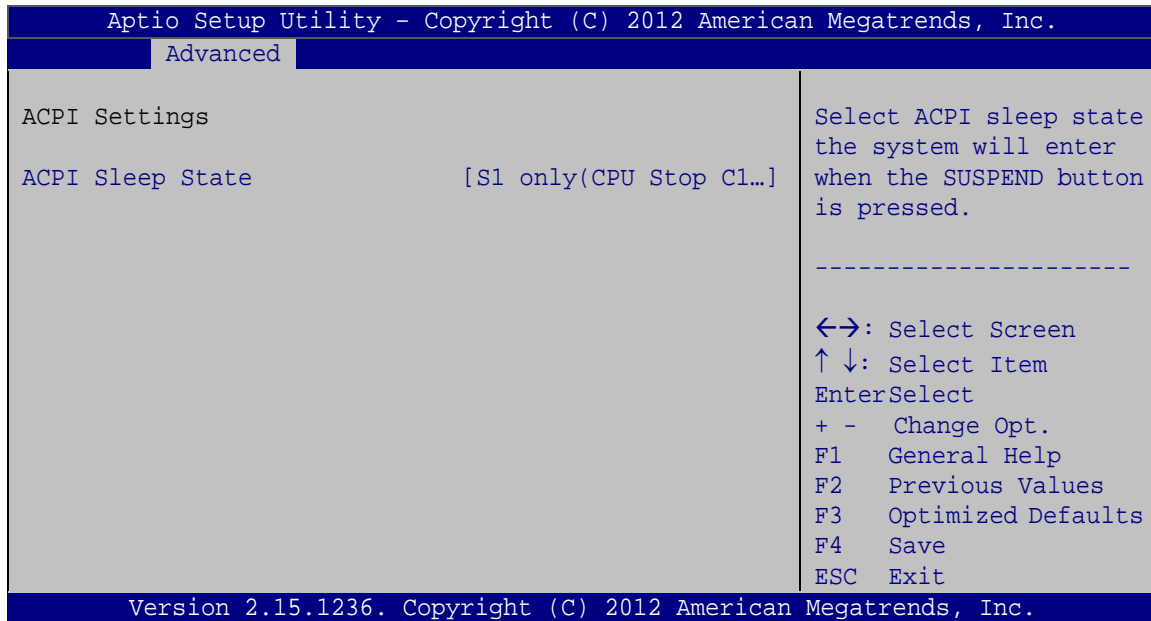

#### BIOS Menu 3: ACPI Configuration

##### → ACPI Sleep State [S1 only (CPU Stop Clock)]

Use the **ACPI Sleep State** option to specify the sleep state the system enters when it is not being used.

- **S1 only (CPU Stop Clock) DEFAULT** The system enters S1(POS) sleep state. The system appears off. The CPU is stopped; RAM is refreshed; the system is running in a low power mode.
- **S3 only (Suspend to RAM)** The caches are flushed and the CPU is powered off. Power to the RAM is maintained. The computer returns slower to a working state, but more power is saved.

### 5.3.2 RTC Wake Settings

The **RTC Wake Settings** menu (**BIOS Menu 4**) configures RTC wake event.

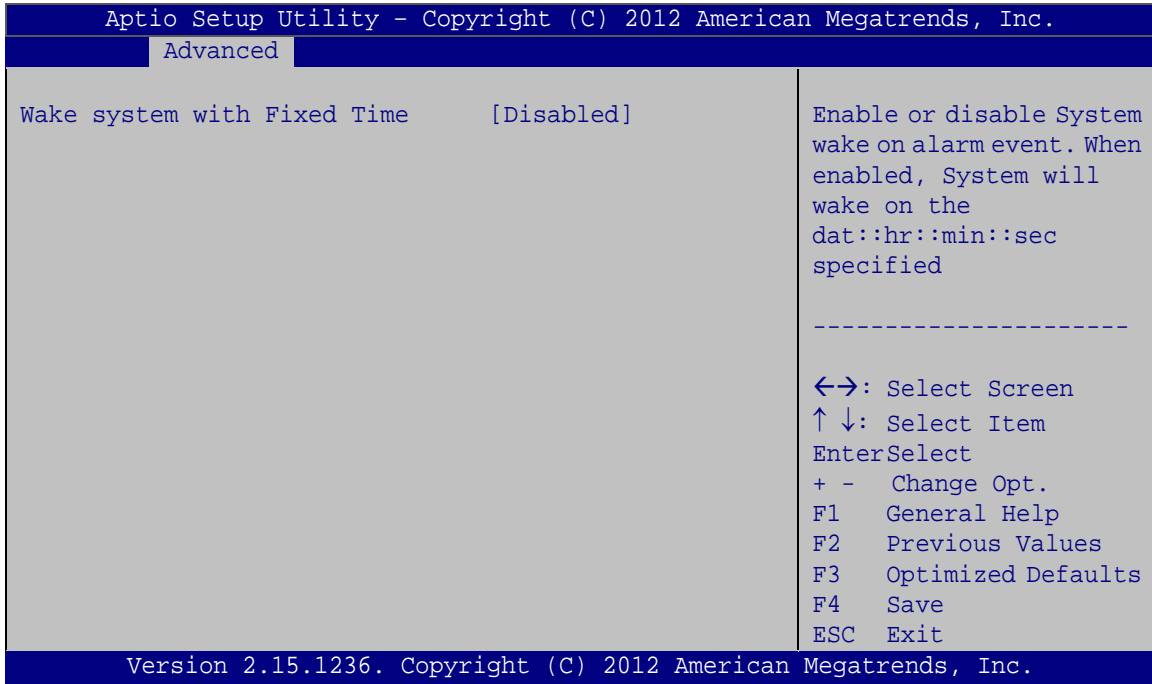

#### BIOS Menu 4: RTC Wake Settings

##### → Wake System with Fixed Time [Disabled]

Use the **Wake System with Fixed Time** option to specify the time the system should be roused from a suspended state.

- **Disabled**    **DEFAULT**    The real time clock (RTC) cannot generate a wake event

## S19A/S24A-QM87i Marine Panel PC

➔ **Enabled**

If selected, the following appears with values that can be selected:

\*Wake up every day

\*Wake up date

\*Wake up hour

\*Wake up minute

\*Wake up second

After setting the alarm, the computer turns itself on from a suspend state when the alarm goes off.

### 5.3.3 Trusted Computing

Use the **Trusted Computing** menu (**BIOS Menu 5**) to configure settings related to the Trusted Computing Group (TCG) Trusted Platform Module (TPM).

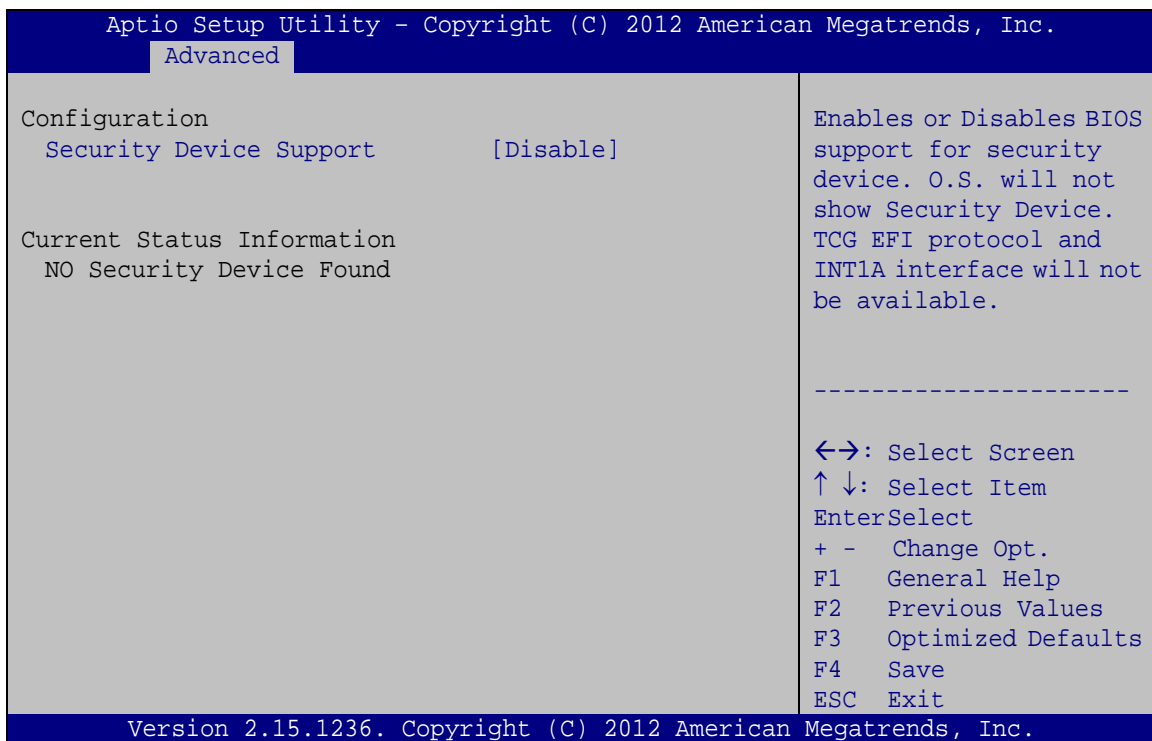

**BIOS Menu 5: Trusted Computing**

➔ **Security Device Support [Disable]**

Use the **Security Device Support** option to configure support for the security devices.

- ➔ **Disable** **DEFAULT** Security device support is disabled.
- ➔ **Enable** Security device support is enabled.

### 5.3.4 CPU Configuration

Use the **CPU Configuration** menu (**BIOS Menu 6**) to view detailed CPU specifications and configure the CPU.

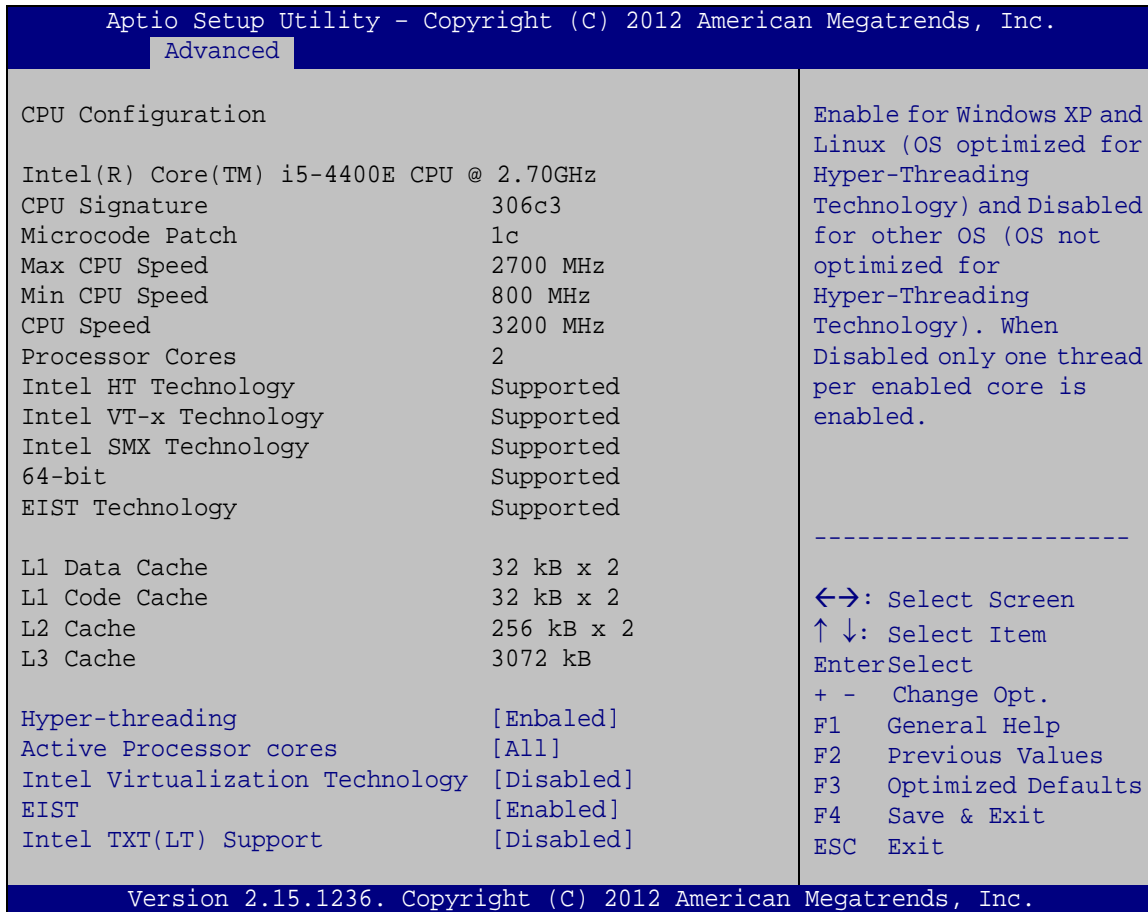

#### BIOS Menu 6: CPU Configuration

The CPU Configuration menu (**BIOS Menu 6**) lists the following CPU details:

- Processor Type: Lists the brand name of the CPU being used

## S19A/S24A-QM87i Marine Panel PC

- CPU Signature: Lists the CPU signature value.
- Microcode Patch: Lists the microcode patch being used.
- Max CPU Speed: Lists the maximum CPU processing speed.
- Min CPU Speed: Lists the minimum CPU processing speed.
- CPU Speed: Lists the CPU processing speed.
- Processor Cores: Lists the number of the processor core
- Intel HT Technology: Indicates if Intel HT Technology is supported by the CPU.
- Intel VT-x Technology: Indicates if Intel VT-x Technology is supported by the CPU.
- Intel SMX Technology: Indicates if Intel SMX Technology is supported by the CPU.
- 64-bit: Indicates if 64-bit OS is supported by the CPU.
- EIST Technology: Indicates if EIST Technology is supported by the CPU.
- L1 Data Cache: Lists the amount of data storage space on the L1 cache.
- L1 Code Cache: Lists the amount of code storage space on the L1 cache.
- L2 Cache: Lists the amount of storage space on the L2 cache.
- L3 Cache: Lists the amount of storage space on the L3 cache.

### → Hyper-threading [Disabled]

Use the **Hyper-threading** option to enable or disable the Intel® Hyper-Threading Technology.

- **Disabled**                      **DEFAULT**      Disable Intel® Hyper-Threading Technology
- **Enabled**                                              Enable Intel® Hyper-Threading Technology

### → Active Processor Cores [All]

Use the **Active Processor Cores** BIOS option to enable numbers of cores in the processor package.

- **All**                                      **DEFAULT**      Enable all cores in the processor package.
- **1**                                              Enable one core in the processor package.

→ **Intel Virtualization Technology [Disabled]**

Use the **Intel Virtualization Technology** option to enable or disable virtualization on the system. When combined with third party software, Intel® Virtualization technology allows several OSs to run on the same system at the same time.

→ **Disabled**                      **DEFAULT**      Disable Intel Virtualization Technology.

→ **Enabled**                                      Enable Intel Virtualization Technology.

→ **EIST [Enabled]**

Use the **EIST** option to enable or disable the Enhanced Intel® SpeedStep Technology (EIST).

→ **Disabled**                                      Disable Enhanced Intel® SpeedStep Technology

→ **Enabled**                      **DEFAULT**      Enable Enhanced Intel® SpeedStep Technology

→ **Intel TXT (LT) Support [Disabled]**

Use the **Intel TXT (LT) Support** option to enable or disable the Intel® Trusted Execution Technology.

→ **Disabled**                      **DEFAULT**      Disable Intel® Trusted Execution Technology

→ **Enabled**                                      Enable Intel® Trusted Execution Technology

## S19A/S24A-QM87i Marine Panel PC

### 5.3.5 SATA Configuration

Use the **SATA Configuration** menu (**BIOS Menu 7**) to change and/or set the configuration of the SATA devices installed in the system.

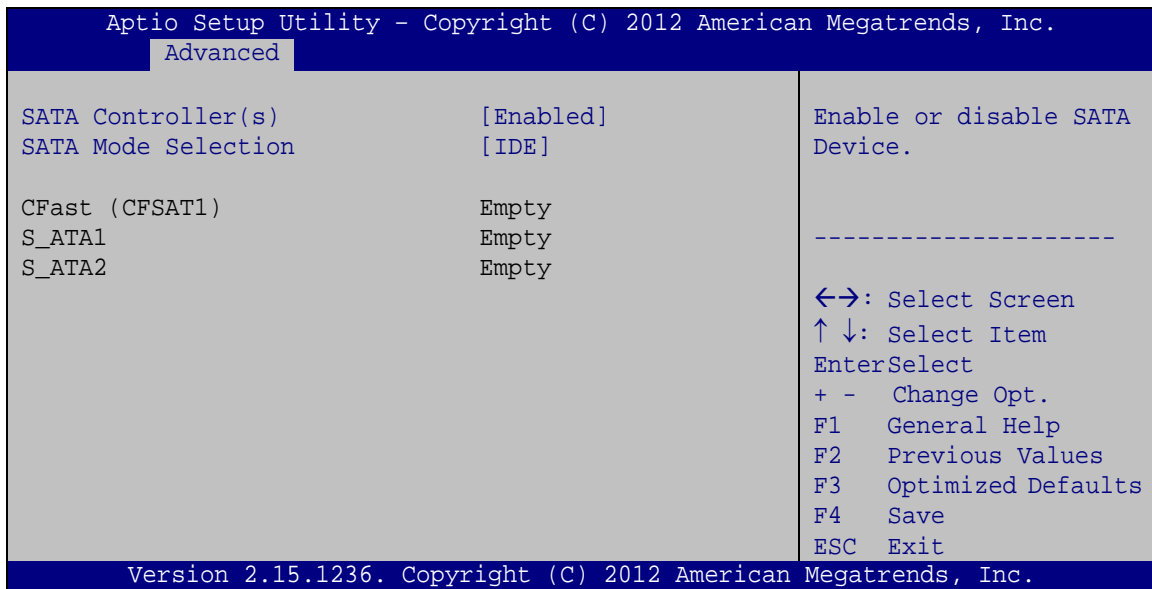

#### BIOS Menu 7: SATA Configuration

##### → SATA Controller(s) [Enabled]

Use the **SATA Controller(s)** option to configure the SATA controller(s).

- **Enabled**      **DEFAULT**      Enable the on-board SATA controller(s).
- **Disabled**                      Disable the on-board SATA controller(s).

##### → SATA Mode Selection [IDE]

Use the **SATA Mode Selection** option to determine how SATA devices operate..

- **IDE**              **DEFAULT**      Configures SATA devices as normal IDE device.
- **AHCI**                              Configures SATA devices as AHCI device.
- **RAID**                              Configures SATA devices as RAID device.

### 5.3.6 Intel Rapid Start Technology

The **Intel Rapid Start Technology** menu (**BIOS Menu 8**) configures Intel® Rapid Start Technology.

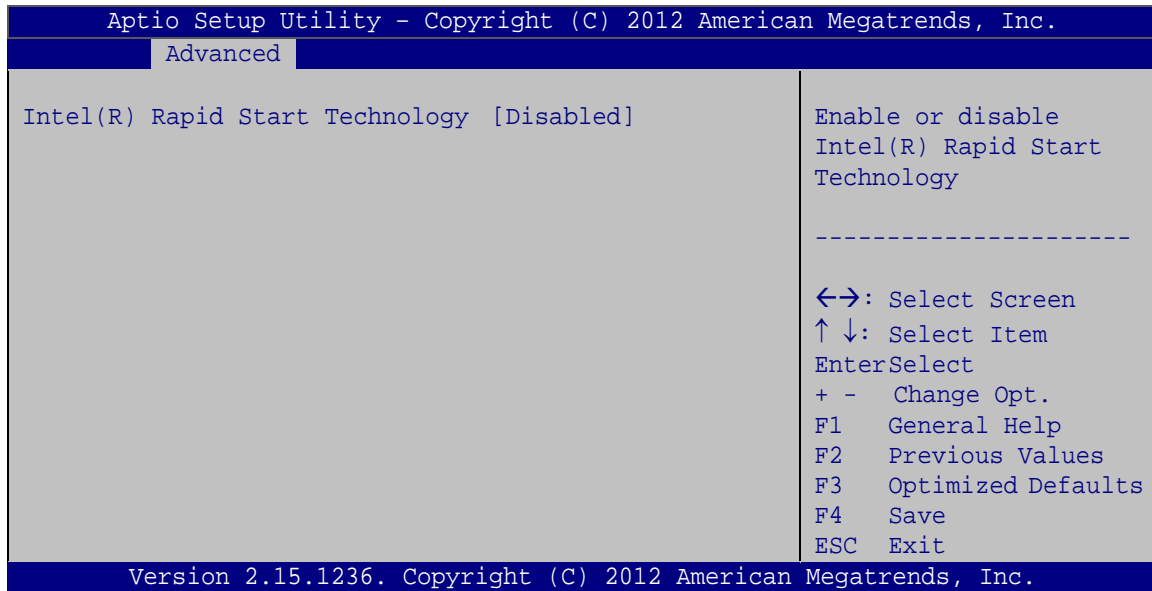

#### **BIOS Menu 8: Intel Rapid Start Technology**

##### ➔ **Intel(R) Rapid Start Technology [Disabled]**

Use the **Intel(R) Rapid Start Technology** option to disable or enable Intel® Rapid Start Technology.

- ➔ **Disabled**      **DEFAULT**      Intel® Rapid Start Technology is disabled.
- ➔ **Enabled**                      Intel® Rapid Start Technology is enabled.



## S19A/S24A-QM87i Marine Panel PC

### 5.3.7 AMT Configuration

The **AMT Configuration** menu (**BIOS Menu 9**) allows advanced power management options to be configured.

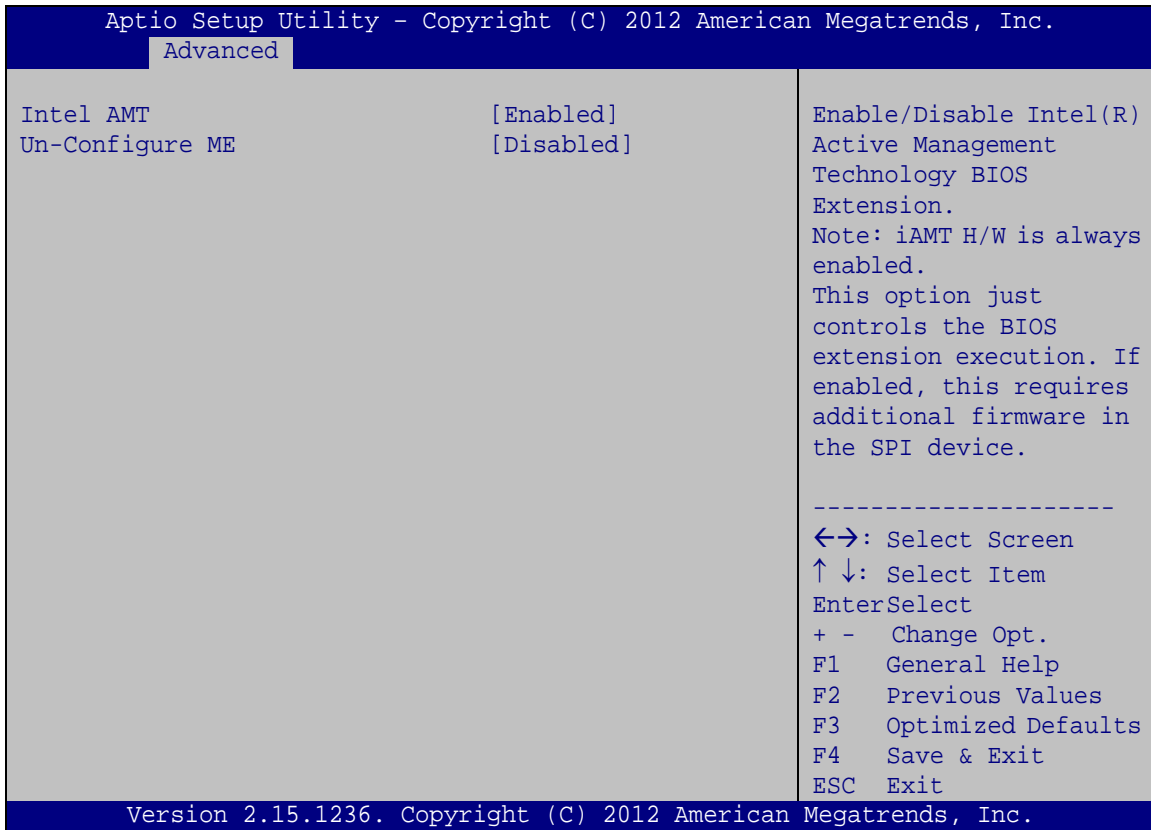

#### BIOS Menu 9: AMT Configuration

##### → Intel AMT [Enabled]

Use **Intel AMT** option to enable or disable the Intel® Active Management Technology.

- **Disabled** Intel® AMT is disabled
- **Enabled** **DEFAULT** Intel® AMT is enabled

##### → Un-Configure ME [Disabled]

Use the **Un-Configure ME** option to perform ME unconfigure without password operation.

- **Disabled** **DEFAULT** Disable ME unconfigure

➔ Enabled Enable ME unconfigure

### 5.3.8 USB Configuration

Use the **USB Configuration** menu (**BIOS Menu 10**) to read USB configuration information and configure the USB settings.

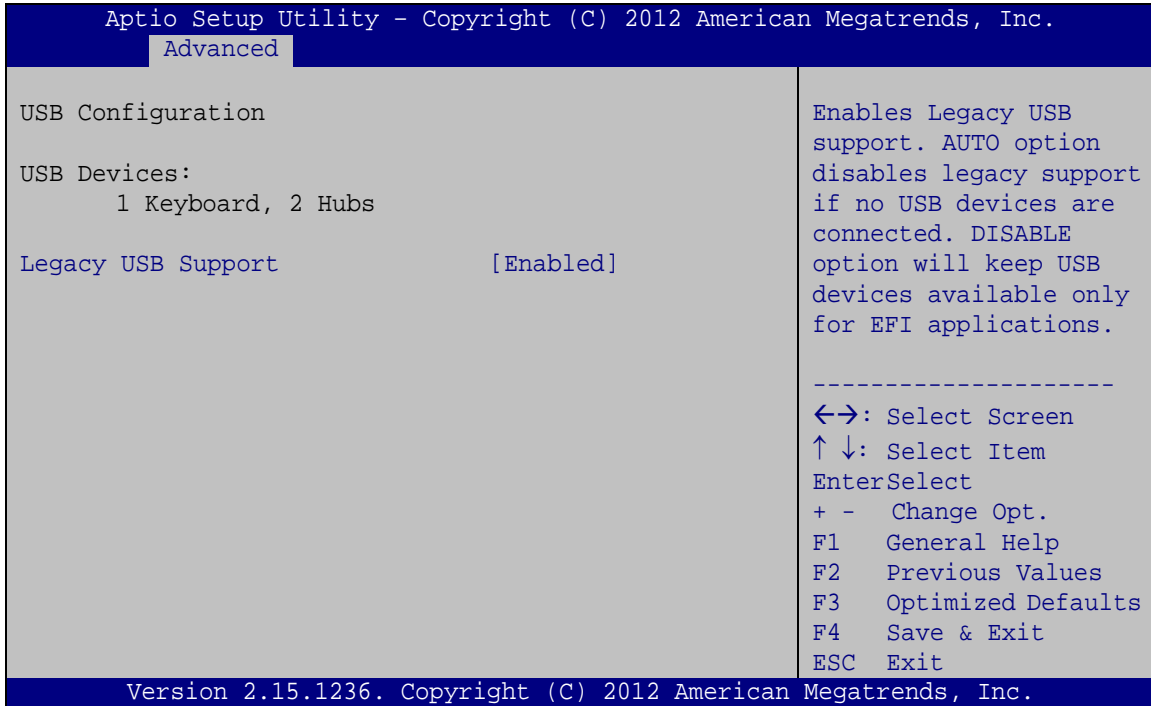

#### BIOS Menu 10: USB Configuration

##### ➔ USB Devices

The **USB Devices Enabled** field lists the USB devices that are enabled on the system

##### ➔ Legacy USB Support [Enabled]

Use the **Legacy USB Support** BIOS option to enable USB mouse and USB keyboard support. Normally if this option is not enabled, any attached USB mouse or USB keyboard does not become available until a USB compatible operating system is fully booted with all USB drivers loaded. When this option is enabled, any attached USB mouse or USB keyboard can control the system even when there is no USB driver loaded onto the system.

## S19A/S24A-QM87i Marine Panel PC

- ➔ **Enabled**      **DEFAULT**      Legacy USB support enabled
- ➔ **Disabled**                      Legacy USB support disabled
- ➔ **Auto**                              Legacy USB support disabled if no USB devices are connected

### 5.3.9 iWDD H/W Monitor

The **iWDD H/W Monitor** menu (**BIOS Menu 11**) displays operating temperature and system voltages.

```

Aptio Setup Utility - Copyright (C) 2012 American Megatrends, Inc.
-----
Advanced
-----
PC Health Status

CPU Temperature           : +52 C
System temperature       : +26 C

CPU_CORE                 : +1.403 V
+5V                      : +5.014 V
+12V                    : +11.611 V
+DDR                    : +1.554 V
+5VSB                   : +4.998 V
+3.3V                   : +3.294 V
+3.3VSB                 : +3.383 V

-----
<=>: Select Screen
↑ ↓: Select Item
Enter>Select
+ - Change Opt.
F1 General Help
F2 Previous Values
F3 Optimized Defaults
F4 Save & Exit
ESC Exit

Version 2.15.1236. Copyright (C) 2012 American Megatrends, Inc.
  
```

#### BIOS Menu 11: iWDD H/W Monitor

##### ➔ H/W Monitor

The following system parameters and values are shown. The system parameters that are monitored are:

- CPU Temperature
- System Temperature
- Voltages:
  - CPU\_CORE
  - +5V
  - +12V
  - +DDR

- +5VSB
- +3.3V
- +3.3VSB

### 5.3.10 F81866 Super IO Configuration

Use the **F81866 Super IO Configuration** menu (**BIOS Menu 12**) to set or change the configurations for the serial ports.

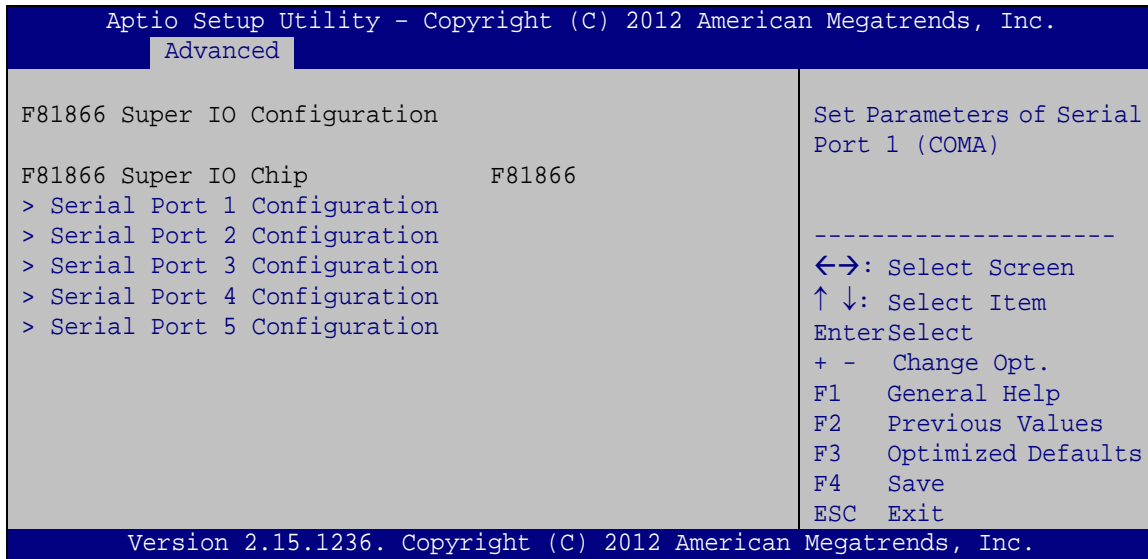

**BIOS Menu 12: F81866 Super IO Configuration**

## S19A/S24A-QM87i Marine Panel PC

### 5.3.10.1 Serial Port n Configuration

Use the **Serial Port n Configuration** menu (**BIOS Menu 13**) to configure the serial port n.

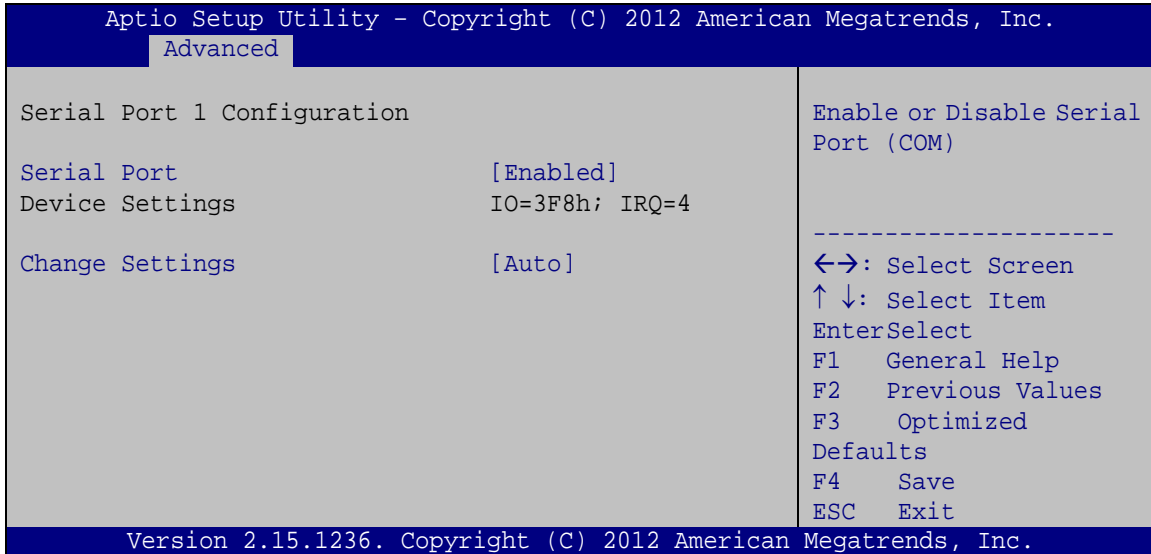

#### BIOS Menu 13: Serial Port n Configuration Menu

##### 5.3.10.1.1 Serial Port 1 Configuration

###### → Serial Port [Enabled]

Use the **Serial Port** option to enable or disable the serial port.

- **Disabled**                      Disable the serial port
- **Enabled**      **DEFAULT**      Enable the serial port

###### → Change Settings [Auto]

Use the **Change Settings** option to change the serial port IO port address and interrupt address.

- **Auto**              **DEFAULT**      The serial port IO port address and interrupt address are automatically detected.
- **IO=3F8h;**  
**IRQ=4**                      Serial Port I/O port address is 3F8h and the interrupt address is IRQ4

- ➔ **IO=3E8h;**  
**IRQ=3, 4**                      Serial Port I/O port address is 3E8h and the interrupt address is IRQ3, 4
- ➔ **IO=2F8h;**  
**IRQ=3, 4**                      Serial Port I/O port address is 2F8h and the interrupt address is IRQ3, 4
- ➔ **IO=2C0h;**  
**IRQ=3, 4**                      Serial Port I/O port address is 2C0h and the interrupt address is IRQ3, 4
- ➔ **IO=2C8h;**  
**IRQ=3, 4**                      Serial Port I/O port address is 2C8h and the interrupt address is IRQ3, 4

**5.3.10.1.2 Serial Port 2 Configuration**

➔ **Serial Port [Enabled]**

Use the **Serial Port** option to enable or disable the serial port.

- ➔ **Disabled**                      Disable the serial port
- ➔ **Enabled      DEFAULT**      Enable the serial port

➔ **Change Settings [Auto]**

Use the **Change Settings** option to change the serial port IO port address and interrupt address.

- ➔ **Auto              DEFAULT**      The serial port IO port address and interrupt address are automatically detected.
- ➔ **IO=2F8h;**  
**IRQ=3**                      Serial Port I/O port address is 2F8h and the interrupt address is IRQ3
- ➔ **IO=3F8h;**  
**IRQ=3, 4**                      Serial Port I/O port address is 3F8h and the interrupt address is IRQ3, 4
- ➔ **IO=2F8h;**  
**IRQ=3, 4**                      Serial Port I/O port address is 2F8h and the interrupt address is IRQ3, 4
- ➔ **IO=2C0h;**  
**IRQ=3, 4**                      Serial Port I/O port address is 2C0h and the interrupt address is IRQ3, 4

## S19A/S24A-QM87i Marine Panel PC

- ➔ **IO=2C8h;**  
**IRQ=3, 4**                      Serial Port I/O port address is 2C8h and the interrupt address is IRQ3, 4

### ➔ **Serial Port Mode [RS485]**

Use the **Serial Port Mode** option to set the Serial Port 2 signaling mode.

- ➔ **RS232**                      Configure Serial Port 2 as RS-232
- ➔ **RS422**                      Configure Serial Port 2 as RS-422
- ➔ **RS485**                      **DEFAULT**                      Configure Serial Port 2 as RS-485

### 5.3.10.1.3 Serial Port 3 Configuration

#### ➔ **Serial Port [Enabled]**

Use the **Serial Port** option to enable or disable the serial port.

- ➔ **Disabled**                      Disable the serial port
- ➔ **Enabled**                      **DEFAULT**                      Enable the serial port

#### ➔ **Change Settings [Auto]**

Use the **Change Settings** option to change the serial port IO port address and interrupt address.

- ➔ **Auto**                      **DEFAULT**                      The serial port IO port address and interrupt address are automatically detected.
- ➔ **IO=3E8h;**  
**IRQ=11**                      Serial Port I/O port address is 3E8h and the interrupt address is IRQ11
- ➔ **IO=3E8h;**  
**IRQ=10, 11**                      Serial Port I/O port address is 3E8h and the interrupt address is IRQ10, 11
- ➔ **IO=2E8h;**  
**IRQ=10, 11**                      Serial Port I/O port address is 2E8h and the interrupt address is IRQ10, 11

- ➔ **IO=2D0h;**  
**IRQ=10, 11**                      Serial Port I/O port address is 2D0h and the interrupt address is IRQ10, 11
- ➔ **IO=2D8h;**  
**IRQ=10, 11**                      Serial Port I/O port address is 2D8h and the interrupt address is IRQ10, 11

➔ **Serial Port Mode [RS485]**

Use the **Serial Port Mode** option to set the Serial Port 3 signaling mode.

- ➔ **RS232**                      Configure Serial Port 3 as RS-232
- ➔ **RS422**                      Configure Serial Port 3 as RS-422
- ➔ **RS485**                      **DEFAULT**                      Configure Serial Port 3 as RS-485

**5.3.10.1.4 Serial Port 4 Configuration**

➔ **Serial Port [Enabled]**

Use the **Serial Port** option to enable or disable the serial port.

- ➔ **Disabled**                      Disable the serial port
- ➔ **Enabled**                      **DEFAULT**                      Enable the serial port

➔ **Change Settings [Auto]**

Use the **Change Settings** option to change the serial port IO port address and interrupt address.

- ➔ **Auto**                      **DEFAULT**                      The serial port IO port address and interrupt address are automatically detected.
- ➔ **IO=2E8h;**  
**IRQ=10**                      Serial Port I/O port address is 2E8h and the interrupt address is IRQ10
- ➔ **IO=3E8h;**  
**IRQ=10, 11**                      Serial Port I/O port address is 3E8h and the interrupt address is IRQ10, 11



## S19A/S24A-QM87i Marine Panel PC

- ➔ **IO=2E8h;**  
**IRQ=10, 11**      Serial Port I/O port address is 2E8h and the interrupt address is IRQ10, 11
- ➔ **IO=2D0h;**  
**IRQ=10, 11**      Serial Port I/O port address is 2D0h and the interrupt address is IRQ10, 11
- ➔ **IO=2D8h;**  
**IRQ=10, 11**      Serial Port I/O port address is 2D8h and the interrupt address is IRQ10, 11

### ➔ **Serial Port Mode [RS485]**

Use the **Serial Port Mode** option to set the Serial Port 4 signaling mode.

- ➔ **RS232**      Configure Serial Port 4 as RS-232
- ➔ **RS422**      Configure Serial Port 4 as RS-422
- ➔ **RS485**      **DEFAULT**      Configure Serial Port 4 as RS-485

### 5.3.10.1.5 Serial Port 5 Configuration

#### ➔ **Serial Port [Enabled]**

Use the **Serial Port** option to enable or disable the serial port.

- ➔ **Disabled**      Disable the serial port
- ➔ **Enabled**      **DEFAULT**      Enable the serial port

#### ➔ **Change Settings [Auto]**

Use the **Change Settings** option to change the serial port IO port address and interrupt address.

- ➔ **Auto**      **DEFAULT**      The serial port IO port address and interrupt address are automatically detected.
- ➔ **IO=2D0h;**  
**IRQ=11**      Serial Port I/O port address is 2D0h and the interrupt address is IRQ11

- IO=2C0h;                      Serial Port I/O port address is 2C0h and the interrupt  
IRQ=10, 11                      address is IRQ10, 11
- IO=2C8h;                      Serial Port I/O port address is 2C8h and the interrupt  
IRQ=10, 11                      address is IRQ10, 11
- IO=2D0h;                      Serial Port I/O port address is 2D0h and the interrupt  
IRQ=10, 11                      address is IRQ10, 11
- IO=2D8h;                      Serial Port I/O port address is 2D8h and the interrupt  
IRQ=10, 11                      address is IRQ10, 11

→ **Serial Port Mode [RS485]**

Use the **Serial Port Mode** option to set the Serial Port 5 signaling mode.

- RS232                      Configure Serial Port 5 as RS-232
- RS422                      Configure Serial Port 5 as RS-422
- RS485                      **DEFAULT**                      Configure Serial Port 5 as RS-485

### 5.3.11 Serial Port Console Redirection

The **Serial Port Console Redirection** menu (**BIOS Menu 14**) allows the console redirection options to be configured. Console redirection allows users to maintain a system remotely by re-directing keyboard input and text output through the serial port.

## S19A/S24A-QM87i Marine Panel PC

```

Aptio Setup Utility - Copyright (C) 2012 American Megatrends, Inc.
  Advanced
COM1
Console Redirection          [Disabled]      Console Redirection
> Console Redirection Settings      Enable/Disable

COM2
Console Redirection          [Disabled]
> Console Redirection Settings

COM3
Console Redirection          [Disabled]
> Console Redirection Settings

COM4
Console Redirection          [Disabled]
> Console Redirection Settings

COM5
Console Redirection          [Disabled]
> Console Redirection Settings

COM6 (BMC) (Disabled)
Console Redirection          Port Is Disabled

iAMT SOL

COM7 (Pci Bus0,Dev0,Func0) (Disabled)
Console Redirection          Port Is Disabled

-----
<->: Select Screen
↑ ↓: Select Item
EnterSelect
+ -  Change Opt.
F1   General Help
F2   Previous Values
F3   Optimized Defaults
F4   Save
ESC  Exit
  
```

Version 2.15.1236. Copyright (C) 2012 American Megatrends, Inc.

### BIOS Menu 14: Serial Port Console Redirection

#### → Console Redirection [Enabled]

Use **Console Redirection** option to enable or disable the console redirection function.

- **Disabled**                      Disabled the console redirection function
- **Enabled**      **DEFAULT**      Enabled the console redirection function

### 5.3.12 IEI Feature

Use the **IEI Feature** menu (**BIOS Menu 15**) to configure One Key Recovery function.

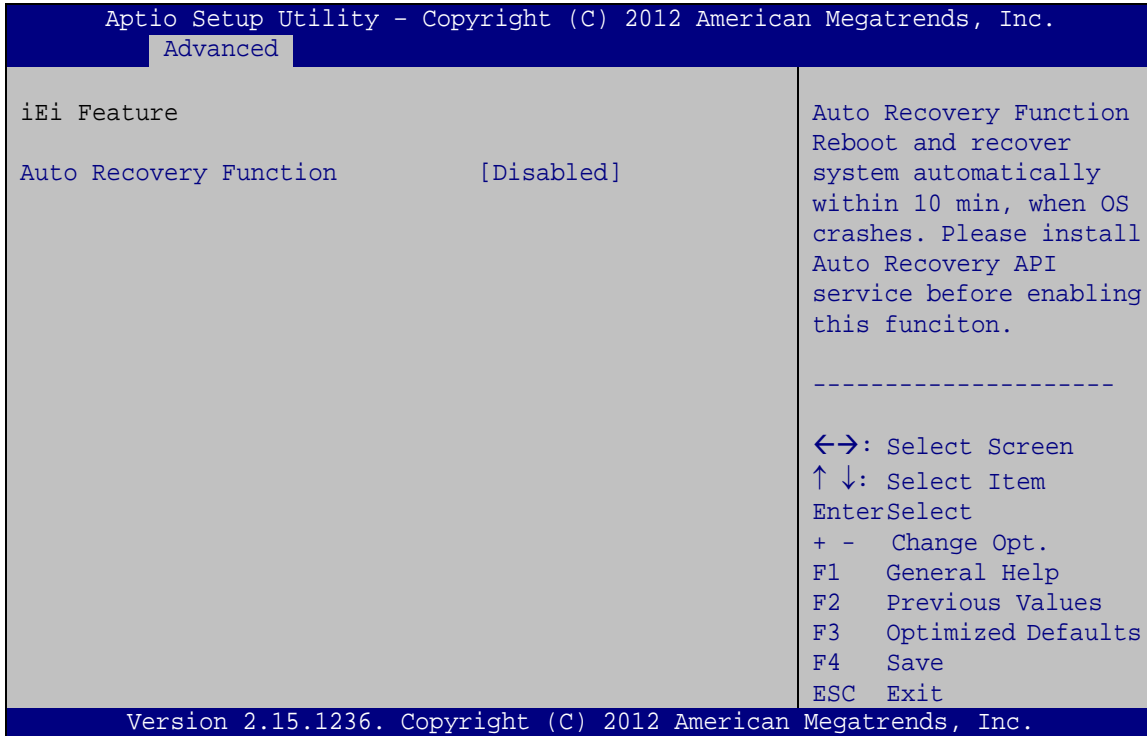

#### BIOS Menu 15: IEI Feature

##### ➔ Auto Recovery Function [Disabled]

Use the **Auto Recovery Function** BIOS option to enable or disable the auto recovery function of the IEI One Key Recovery.

- ➔ **Disabled**     **DEFAULT**     Auto recovery function disabled
- ➔ **Enabled**     Auto recovery function enabled

## S19A/S24A-QM87i Marine Panel PC

### 5.4 Chipset

Use the Chipset menu (**BIOS Menu 16**) to configure the system chipset.

```

Aptio Setup Utility - Copyright (C) 2012 American Megatrends, Inc.
Main    Advanced  Chipset    Boot    Security  Save & Exit  Server Mgmt
-----
> PCH-IO Configuration
> System Agent (SA) Configuration

PCH Parameters
-----
<=>: Select Screen
↑↓: Select Item
Enter>Select
+ - Change Opt.
F1  General Help
F2  Previous Values
F3  Optimized Defaults
F4  Save & Exit
ESC Exit

Version 2.15.1236. Copyright (C) 2012 American Megatrends, Inc.
  
```

**BIOS Menu 16: Chipset**

#### 5.4.1 PCH-IO Configuration

Use the **PCH-IO Configuration** menu (**BIOS Menu 17**) to configure the PCH-IO chipset.

```

Aptio Setup Utility - Copyright (C) 2012 American Megatrends, Inc.
-----
Chipset
-----
Auto Power Button Status      [Disable (ATX)]
Restore AC power Loss         [Last State]
Azalia (HD Audio)              [Enabled]
Serial IRQ Mode                [Continuous]
Power Saving Function(ERP)     [Disabled]

Control Detection of the Azalia device.
Disabled = Azalia will be unconditionally disabled
Enabled = Azalia will be unconditionally Enabled.
-----
<=>: Select Screen
↑↓: Select Item
Enter>Select
+ - Change Opt.
F1  General Help
F2  Previous Values
F3  Optimized Defaults
F4  Save & Exit
ESC Exit

Version 2.15.1236. Copyright (C) 2012 American Megatrends, Inc.
  
```

**BIOS Menu 17: PCH-IO Configuration**

**→ Restore on AC Power Loss [Last State]**

Use the **Restore on AC Power Loss** BIOS option to specify what state the system returns to if there is a sudden loss of power to the system.

- **Power Off**                      The system remains turned off
- **Power On**                      The system turns on
- **Last State    DEFAULT**      The system returns to its previous state. If it was on, it turns itself on. If it was off, it remains off.

**→ Azalia (HD Audio) [Enabled]**

Use the **Azalia (HD Audio)** option to enable or disable the High Definition Audio controller.

- **Disabled**                      The onboard High Definition Audio controller is disabled
- **Enabled        DEFAULT**      The onboard High Definition Audio controller automatically detected and enabled

**→ Serial IRQ Mode [Continuous]**

Use the **Serial IRQ Mode** option to configure serial IRQ mode for serial interrupts. Configuration options are listed below:

- **Quiet**
- **Continuous    DEFAULT**

**→ Power Saving Function (ERP) [Disabled]**

Use the **Power Saving Function (ERP)** option to enable or disable the power saving function.

- **Disabled        DEFAULT**      Disable the power saving function.
- **Enabled**                      Enable the power saving function.

## S19A/S24A-QM87i Marine Panel PC

### 5.4.2 System Agent (SA) Configuration

Use the **System Agent (SA) Configuration** menu (**BIOS Menu 18**) to configure the System Agent (SA) parameters.

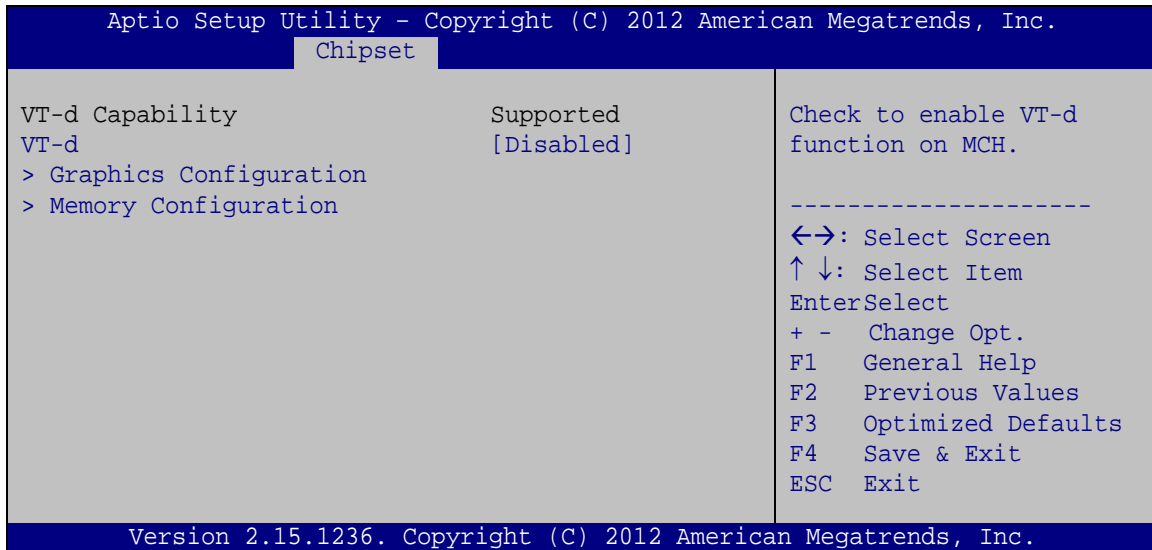

#### BIOS Menu 18: System Agent (SA) Configuration

##### → VT-d [Disabled]

Use the **VT-d** option to enable or disable VT-d support.

- **Disabled** **DEFAULT** Disable VT-d support.
- **Enabled** Enable VT-d support.

### 5.4.2.1 Graphics Configuration

Use the **Graphics Configuration** submenu (**BIOS Menu 19**) to configure the graphics settings.

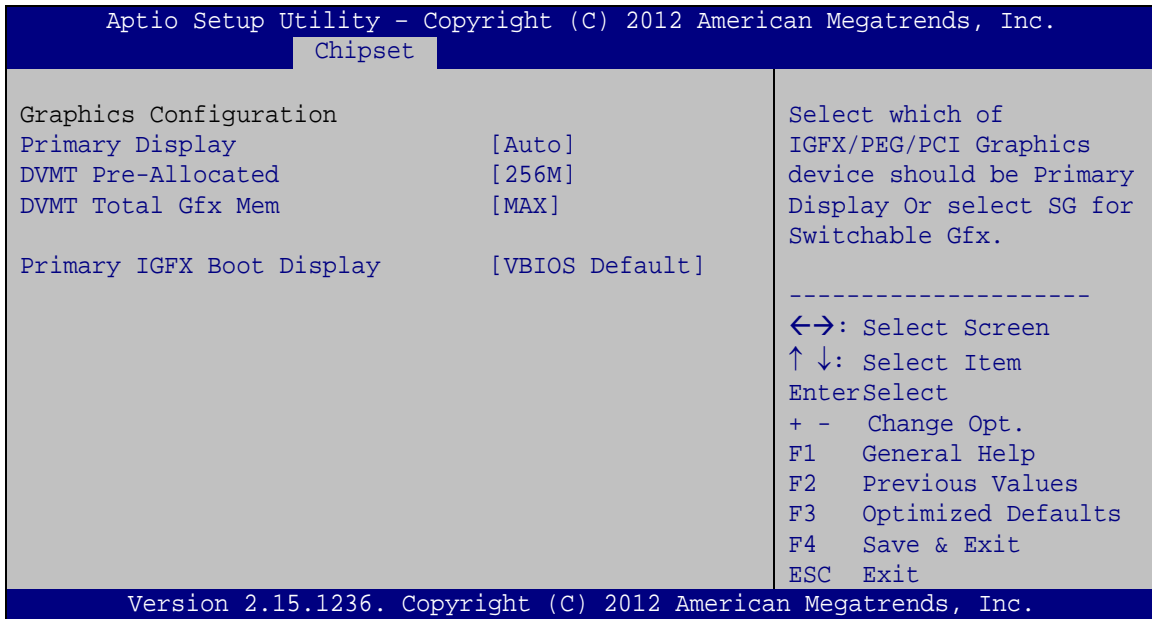

#### BIOS Menu 19: Graphics Configuration

##### → Primary Display [Auto]

Use the **Primary Display** option to select the graphics controller used as the primary boot device. Configuration options are listed below:

- Auto **Default**
- IGFX
- PCIE

##### → DVMT Pre-Allocated [256M]

Use the **DVMT Pre-Allocated** option to set the amount of system memory allocated to the integrated graphics processor when the system boots. The system memory allocated can then only be used as graphics memory, and is no longer available to applications or the operating system. Configuration options are listed below:

- 32M



**S19A/S24A-QM87i Marine Panel PC**

- 64M
- 128M
- 256M           **Default**
- 512M

**→ DVMT Total Gfx Mem [256M]**

Use the **DVMT Total Gfx Mem** option to select DVMT5.0 total graphic memory size used by the internal graphic device. The following options are available:

- 128M
- 256M
- MAX           **DEFAULT**

**→ Primary IGFX Boot Display [VBIOS Default]**

Use the **Primary IGFX Boot Display** option to select the display device used by the system when it boots. Configuration options are listed below.

- VBIOS Default   **DEFAULT**
- CRT
- DVI
- HDMI 1
- Display port 1

### 5.4.3 Memory Configuration

Use the **Memory Configuration** submenu (**BIOS Menu 20**) to display the memory information.

```

Aptio Setup Utility - Copyright (C) 2012 American Megatrends, Inc.
Chipset
Memory Information
Memory Frequency          1600 Mhz
Total Memory              4096 MB (DDR3)
DIMM 1                    2048 MB (DDR3)
DIMM 1                    2048 MB (DDR3)
-----
<->: Select Screen
↑ ↓: Select Item
EnterSelect
+ - Change Opt.
F1  General Help
F2  Previous Values
F3  Optimized Defaults
F4  Save & Exit
ESC Exit

Version 2.15.1236. Copyright (C) 2012 American Megatrends, Inc.
    
```

**BIOS Menu 20: Memory Configuration**

### 5.5 Boot

Use the **Boot** menu (**BIOS Menu 21**) to configure system boot options.

```

Aptio Setup Utility - Copyright (C) 2012 American Megatrends, Inc.
Main  Advanced  Chipset  Boot  Security  Save & Exit  Server Mgmt
Boot Configuration
Bootup NumLock State      [On]
Quiet Boot                 [Enabled]
Option ROM Messages       [Force BIOS]
Launch PXE OpROM          [Disabled]
UEFI Boot                  [Disabled]
-----
Select the keyboard
NumLock state
-----
<->: Select Screen
↑ ↓: Select Item
EnterSelect
+ - Change Opt.
F1  General Help
F2  Previous Values
F3  Optimized Defaults
F4  Save & Exit
ESC Exit

Boot Option Priorities

Version 2.15.1236. Copyright (C) 2012 American Megatrends, Inc.
    
```

**BIOS Menu 21: Boot**

## S19A/S24A-QM87i Marine Panel PC

### → **Bootup NumLock State [On]**

Use the **Bootup NumLock State** BIOS option to specify if the number lock setting must be modified during boot up.

- **On**                      **DEFAULT**                      Allows the Number Lock on the keyboard to be enabled automatically when the computer system boots up. This allows the immediate use of the 10-key numeric keypad located on the right side of the keyboard. To confirm this, the Number Lock LED light on the keyboard is lit.
- **Off**                                      Does not enable the keyboard Number Lock automatically. To use the 10-keys on the keyboard, press the Number Lock key located on the upper left-hand corner of the 10-key pad. The Number Lock LED on the keyboard lights up when the Number Lock is engaged.

### → **Quiet Boot [Enabled]**

Use the **Quiet Boot** BIOS option to select the screen display when the system boots.

- **Disabled**                                      Normal POST messages displayed
- **Enabled**                      **DEFAULT**                      OEM Logo displayed instead of POST messages

### → **Option ROM Messages [Force BIOS]**

Use the **Option ROM Messages** option to set the Option ROM display mode.

- **Force BIOS**                      **DEFAULT**                      Sets display mode to force BIOS.
- **Keep Current**                                      Sets display mode to current.

➔ **Launch PXE OpROM [Disabled]**

Use the **Launch PXE OpROM** option to enable or disable boot option for legacy network devices.

- ➔ **Disabled**     **DEFAULT**     Ignore all PXE Option ROMs
- ➔ **Enabled**                     Load PXE Option ROMs

➔ **UEFI Boot [Disabled]**

Use the **UEFI Boot** option to enable or disable to boot from the UEFI devices.

- ➔ **Disabled**     **DEFAULT**     Boot from UEFI devices is disabled.
- ➔ **Enabled**                     Boot from UEFI devices is enabled.

## 5.6 Security

Use the **Security** menu (**BIOS Menu 22**) to set system and user passwords.

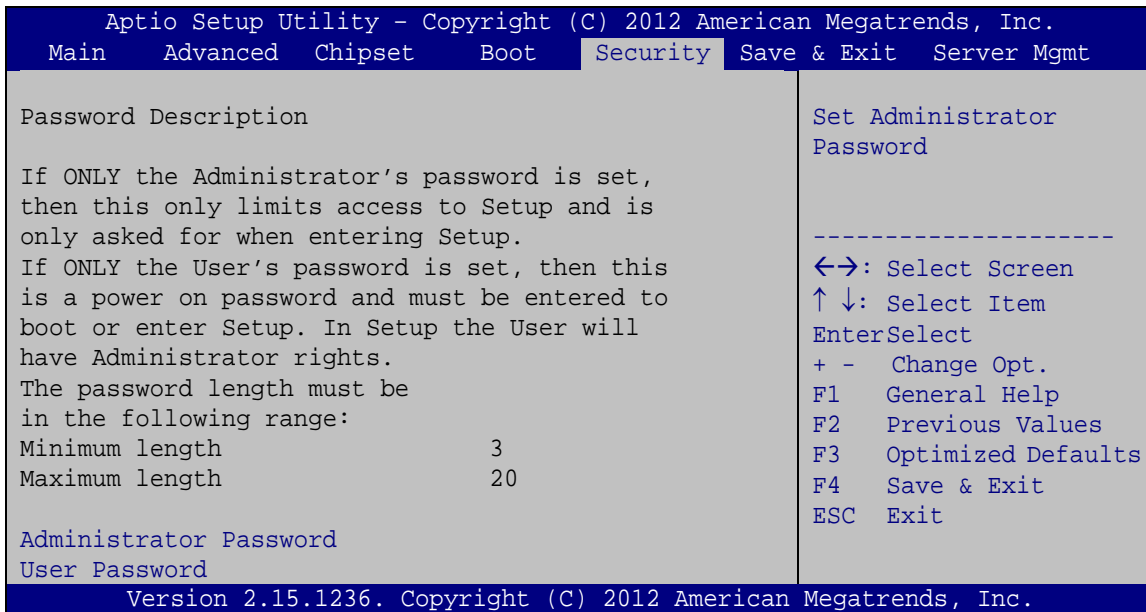

**BIOS Menu 22: Security**

➔ **Administrator Password**

Use the **Administrator Password** to set or change a administrator password.

## S19A/S24A-QM87i Marine Panel PC

### → User Password

Use the **User Password** to set or change a user password.

## 5.7 Save & Exit

Use the **Save & Exit** menu (**BIOS Menu 23**) to load default BIOS values, optimal failsafe values and to save configuration changes.

```

Aptio Setup Utility - Copyright (C) 2012 American Megatrends, Inc.
Main   Advanced  Chipset  Boot   Security  Save & Exit  Server Mgmt
-----
Save Changes and Reset
Discard Changes and Reset

Restore Defaults
Save as User Defaults
Restore User Defaults

Reset the system after
saving the changes.

-----
←→: Select Screen
↑ ↓: Select Item
EnterSelect
+ - Change Opt.
F1  General Help
F2  Previous Values
F3  Optimized Defaults
F4  Save & Exit
ESC Exit

Version 2.15.1236. Copyright (C) 2012 American Megatrends, Inc.

```

### BIOS Menu 23: Save & Exit

#### → Save Changes and Reset

Use the **Save Changes and Reset** option to save the changes made to the BIOS options and reset the system.

#### → Discard Changes and Reset

Use the **Discard Changes and Reset** option to exit the system without saving the changes made to the BIOS configuration setup program.

#### → Restore Defaults

Use the **Restore Defaults** option to load the optimal default values for each of the parameters on the Setup menus. **F3 key can be used for this operation.**

➔ **Save as User Defaults**

Use the **Save as User Defaults** option to save the changes done so far as user defaults.

➔ **Restore User Defaults**

Use the **Restore User Defaults** option to restore the user defaults to all the setup options.

## 5.8 Server Management

Use the **Server Mgmt** menu (**BIOS Menu 24**) to configure BMC network parameters.

```

Aptio Setup Utility - Copyright (C) 2012 American Megatrends, Inc.
Main   Advanced  Chipset   Boot     Security  Save & Exit  Server Mgmt
-----
BMC Self Test Status          FAILED
> System Event Log
> BMC network configuration

Configure BMC network
parameters
-----
<->: Select Screen
↑ ↓: Select Item
Enter>Select
+ -  Change Opt.
F1   General Help
F2   Previous Values
F3   Optimized Defaults
F4   Save & Exit
ESC  Exit

Version 2.15.1236. Copyright (C) 2012 American Megatrends, Inc.
    
```

**BIOS Menu 24: Server Management**

## S19A/S24A-QM87i Marine Panel PC

### 5.8.1 System Event Log

Use the **System Event Log** menu (**BIOS Menu 25**) to configure the system event log of the BMC.

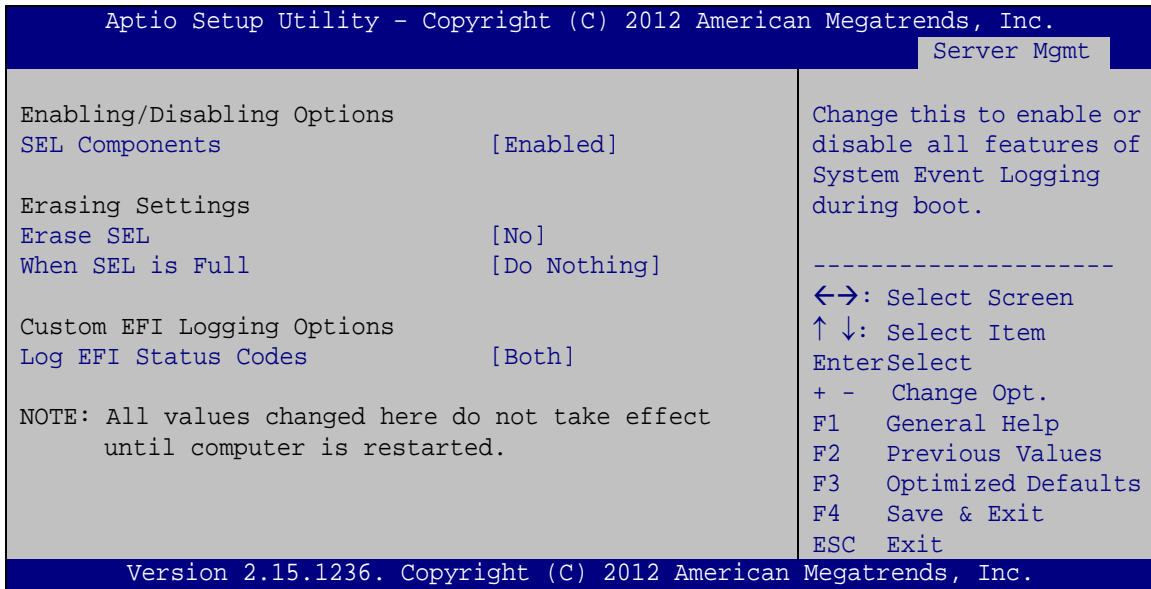

#### BIOS Menu 25: System Event Log

##### → SEL Components [Enabled]

Use the **SEL Components** option to enable or disable all features of System Event Log (SEL) when the system boots.

- **Disabled**      **DEFAULT**      System Event Log is disabled.
- **Enabled**                      System Event Log is enabled.

##### → Erase SEL [No]

Use the **Erase SEL** option for erasing SEL.

- **No**                      **DEFAULT**      Do not erase system event log.
- **Yes, On next reset**                      Erase system event log on next reset.

→ **Yes, On every reset** Erase system event log on every reset.

→ **When SEL is Full [Do Nothing]**

Use the **When SEL is Full** option to select an reaction to a full SEL.

→ **Do Nothing**      **DEFAULT**      Do not do anything when SEL is full.

→ **Erase Immediately** Erase SEL immediately when SEL is full.

→ **Log EFI Status Codes [Both]**

Use the **Log EFI Status Codes** option to configure how to log Extensible Firmware Interface (EFI) status codes.

→ **Disabled**      **DEFAULT**      Disable the logging of EFI status codes.

→ **Both** Log both error codes and progress codes.

→ **Error code** Log error codes only.

→ **Progress code** Log progress codes only.



## S19A/S24A-QM87i Marine Panel PC

### 5.8.2 BMC Network Configuration

Use the **BMC Network Configuration** menu (**BIOS Menu 26**) to configure the BMC network parameters.

```

Aptio Setup Utility - Copyright (C) 2012 American Megatrends, Inc.
Server Mgmt
BMC network configuration
Lan channel 1
Configuration Address source      [Unspecified]
Station IP address                -
Subnet mask                       -
Station MAC address               -
Router IP address                 -
Router MAC address                -

Select to configure LAN
channel parameters
statically or
dynamically (by BIOS or
BMC). Unspecified option
will not modify any BMC
network parameters
during BIOS phase.

-----
←→: Select Screen
↑ ↓: Select Item
EnterSelect
+ - Change Opt.
F1 General Help
F2 Previous Values
F3 Optimized Defaults
F4 Save & Exit
ESC Exit

Version 2.15.1236. Copyright (C) 2012 American Megatrends, Inc.
  
```

#### BIOS Menu 26: BMC Network Configuration

##### → Configuration Address source [Unspecified]

Use the **Configuration Address source** option to configure LAN channel parameters statically or dynamically (by BIOS or BMC). Choosing the **Unspecified** option will not modify any BMC network parameters during BIOS phase. The following options are available:

- Unspecified     **DEFAULT**
- Static
- Dynamic-Obtained by BMC
- Dynamic-Loaded by BIOS
- Dynamic-BMC running other Protocol

Chapter

**6**

# Maintenance

---

## S19A/S24A-QM87i Marine Panel PC

---



### **WARNING:**

Take Anti-Static precautions whenever maintenance is being carried out on the system components. Failure to take anti-static precautions can cause permanent system damage. For more details on anti-static precautions, please refer to **Section 2.1**.

---

## 6.1 System Maintenance Overview

---



### **NOTE:**

When doing maintenance operations on the system, please follow the instructions in this chapter. Failure to follow these instructions may lead to personal injury and system damage.

---

To preserve the working integrity of the S19A/S24A-QM87i, the system must be properly maintained. If internal components need replacement, the proper maintenance procedures must be followed to ensure the system can continue to operate normally.

## 6.2 SO-DIMM Replacement Procedure

---



### **WARNING!**

Users are not advised to attempt to repair or replace any internal or external components of the S19A/S24A-QM87i other than those listed below. If any other components fail or need replacement, contact the IEI reseller or vendor you purchased the S19A/S24A-QM87i from or contact an IEI sales representative directly. To contact an IEI sales representative, please send an email to [sales@ieiworld.com](mailto:sales@ieiworld.com).

---

**WARNING:**

1. Using incorrectly specified SO-DIMM may cause permanently damage the S19A/S24A-QM87i. Please make sure the purchased SO-DIMM complies with the memory specifications of the S19A/S24A-QM87i.
2. For dual channel configuration, always install two identical memory modules that feature the same capacity, timings, voltage, number of ranks and the same brand.

To replace a SO-DIMM into a SO-DIMM socket, please follow the steps below.

**Step 1:** Remove the SBOX computer from the S19A/S24A-QM87i rear panel by removing/loosing the six retention screws indicated in **Figure 6-1**. Slide the SBOX computer downward and lift the SBOX.

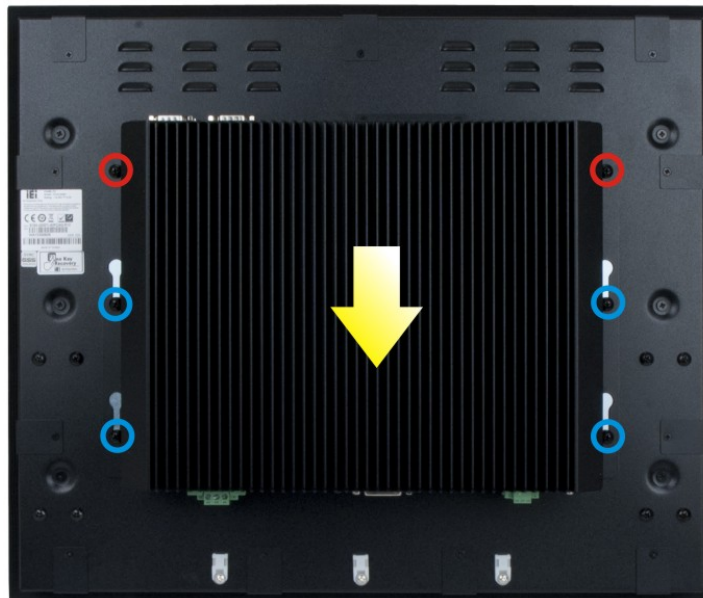

○ : Remove completely  
○ : Loose the screws,  
but do not remove

Figure 6-1: SBOX Computer Retention Screws

## S19A/S24A-QM87i Marine Panel PC



### WARNING:

Please do not completely remove the four screws circled in blue in the above diagram. Doing so may cause damage to the system when re-installing the SBOX computer.

**Step 2:** Remove the bottom cover by removing the 11 retention screws.



Figure 6-2: Bottom Cover Retention Screws

**Step 3:** Locate the SO-DIMM. (Figure 6-3).

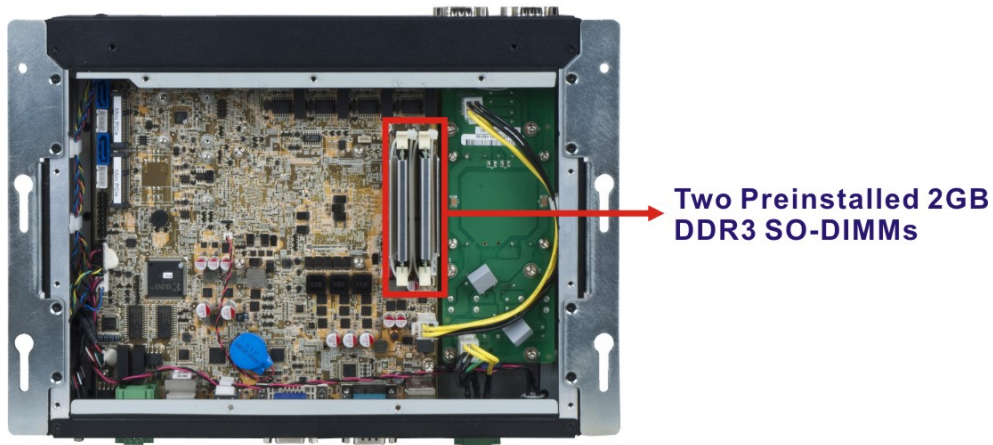

Figure 6-3: SO-DIMM Locations

- Step 4:** Remove the cable tie that secures the heatsink with the SO-DIMM. Then, remove the heatsink.
- Step 5:** Release the arms on the SO-DIMM socket to remove the SO-DIMM.
- Step 6:** Align the new SO-DIMM with the socket. The SO-DIMM must be oriented in such a way that the notch in the middle of the SO-DIMM must be aligned with the plastic bridge in the socket (**Figure 6-4**).
- Step 7:** Press the SO-DIMM down until the arms of the SO-DIMM socket clip into place and secure the SO-DIMM in the socket (**Figure 6-4**).

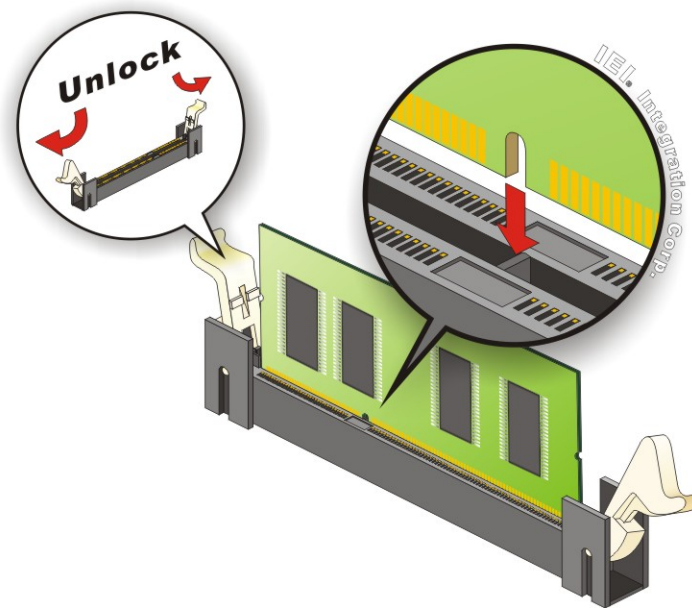

Figure 6-4: SO-DIMM Installation

- Step 8:** Place the heatsink and use a cable tie to secure the heatsink with the SO-DIMM.
- Step 9:** Reinstall the bottom cover.
- Step 10:** Reinstall the SBOX computer onto the rear panel of the S19A/S24A-QM87i.

Chapter

7

# Interface Connectors

---

## 7.1 Peripheral Interface Connectors

The S19A/S24A-QM87i motherboard comes with a number of peripheral interface connectors and configuration jumpers. The connector locations are shown in **Figure 7-1** and **Figure 7-2**. The Pin 1 locations of the on-board connectors are also indicated in the diagrams below. The connector pinouts for these connectors are listed in the following sections.

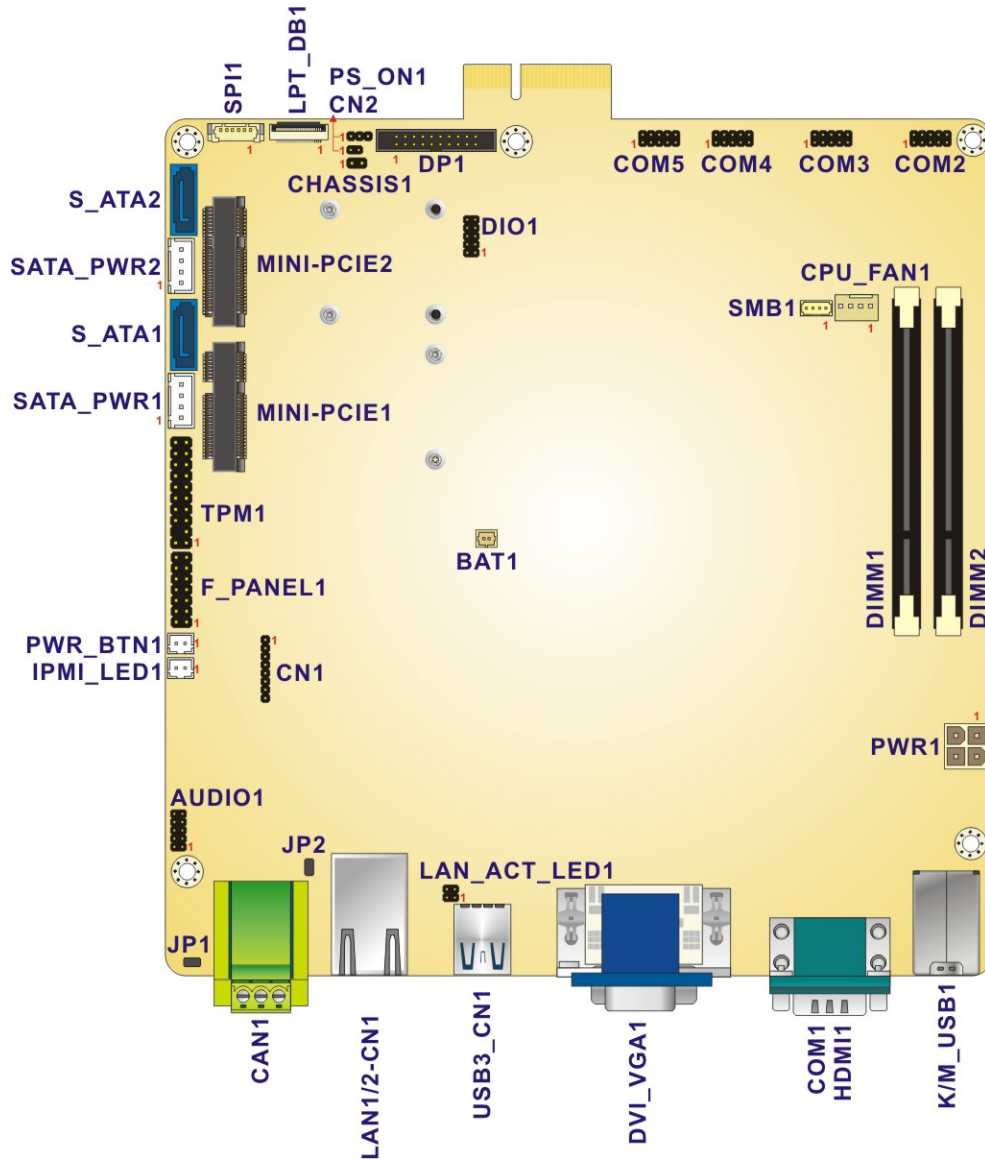

**Figure 7-1: Main Board Layout Diagram (Front Side)**



S19A/S24A-QM87i Marine Panel PC

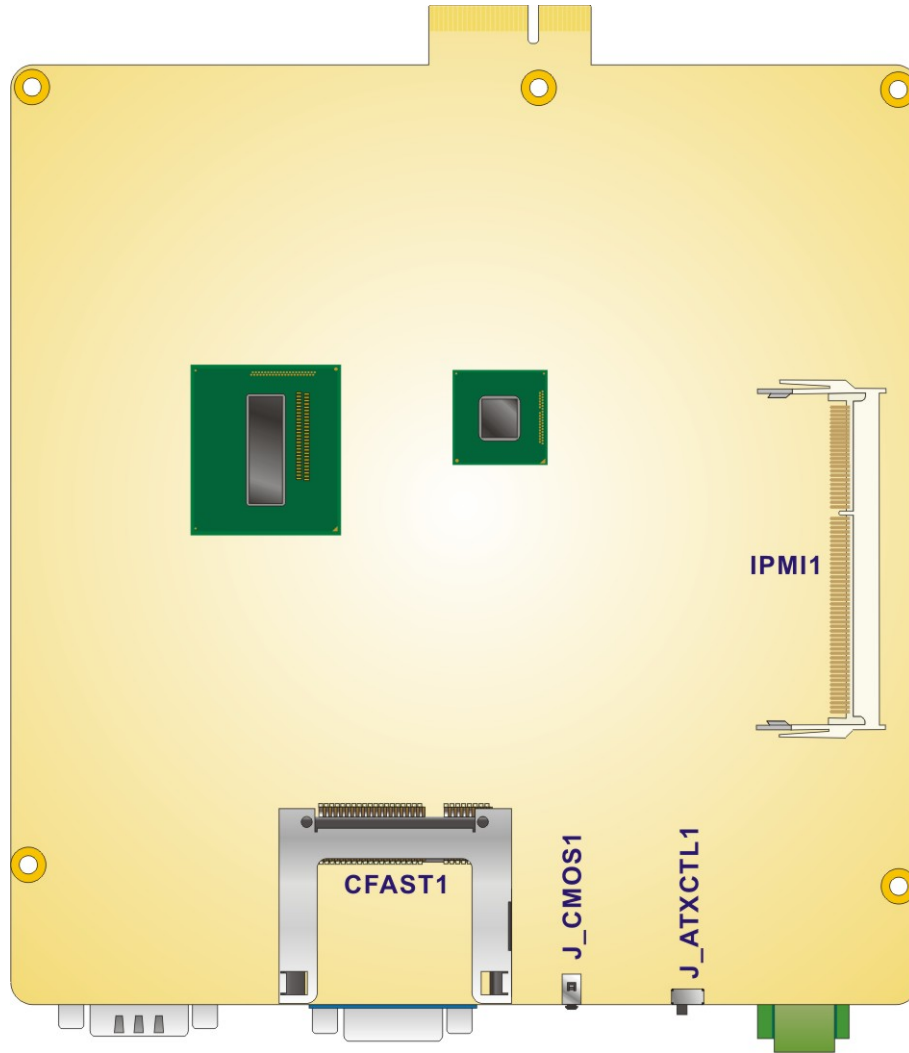

Figure 7-2: Main Board Layout Diagram (Solder Side)

## 7.2 Internal Peripheral Connectors

Internal peripheral connectors are found on the motherboard and are only accessible when the motherboard is outside of the chassis. The table below shows a list of the peripheral interface connectors on the S19A/S24A-QM87i motherboard. Pinouts of these connectors can be found in the following sections.

Connector	Type	Label
Audio connector	10-pin header	AUDIO1
Battery connector	2-pin wafer	BAT1
CFast card slot	CFast card slot	CFAST1
Chassis intrusion connector	2-pin header	CHASSIS1
Digital I/O connector	10-pin header	DIO1
EC debug connector	20-pin FPC	LPT_DB1
Fan connector	4-pin wafer	CPU_FAN1
Front panel connector	14-pin header	F_PANEL1
IPMI LED connector	2-pin wafer	IPMI_LED1
iRIS module socket	204-pin socket	IPMI1
LAN active LED connector	4-pin header	LAN_ACT_LED1
PCIe Mini card slots	PCIe Mini card slot	MINI-PCIE1 MINI-PCIE2
Power connector	4-pin connector	PWR1
Power button connector	2-pin wafer	PWR_BTN1
PS_ON connector	3-pin header	PS_ON1
RS-232/422/485 connector	10-pin header	COM2, COM3, COM4, COM5
SATA connectors	7-pin connector	S_ATA1 S_ATA2
SATA power connectors	4-pin wafer	SATA_PWR1 SATA_PWR2

## S19A/S24A-QM87i Marine Panel PC

Connector	Type	Label
SMBus connector	4-pin wafer	SMB1
SO-DIMM connectors	SO-DIMM connector	DIMM1, DIMM2
SPI Flash connector	6-pin wafer	SPI1
SPI Flash connector (EC)	2-pin header	CN2
TPM connector	20-pin header	TPM1

**Table 7-1: Peripheral Interface Connectors**

### 7.2.1 Audio Connector (AUDIO1)

PIN NO.	DESCRIPTION	PIN NO.	DESCRIPTION
1	SPK_OUT-R	2	LINE_IN-R
3	GND	4	GND
5	SPK_OUT-L	6	LINE_IN-L
7	GND	8	GND
9	MIC-R	10	MIC-L

**Table 7-2: Audio Connector (AUDIO1) Pinouts**

### 7.2.2 Battery Connector (BAT1)

PIN NO.	DESCRIPTION
1	VBATT
2	GND

**Table 7-3: Battery Connector (BAT1) Pinouts**

### 7.2.3 Chassis Intrusion Connector (CHASSIS1)

PIN NO.	DESCRIPTION
1	+V3.3A_EC
2	CHASSIE_EC

**Table 7-4: Chassis Intrusion Connector (CHASSIS1) Pinouts**

### 7.2.4 Digital I/O Connector (DIO1)

PIN NO.	DESCRIPTION	PIN NO.	DESCRIPTION
1	GND	2	+5V
3	DOUT3	4	DOUT2
5	DOUT1	6	DOUT0
7	DIN3	8	DIN2
9	DIN1	10	DIN0

**Table 7-5: Digital I/O Connector (DIO1) Pinouts**

### 7.2.5 EC Debug Connector (LPT\_DB1)

PIN NO.	DESCRIPTION	PIN NO.	DESCRIPTION
1	KSIO	2	KSO0
3	KSO1	4	KSO2
5	KSO3	6	KSO4
7	KSO5	8	KSO6
9	KSO7	10	KSO8
11	KSO9	12	KSO10
13	KSO12	14	KSI1
15	KSO11	16	KSI2
17	KSI3	18	GND
19	GND	20	GND

**Table 7-6: EC Debug Connector (LPT\_DB1) Pinouts**

### 7.2.6 Fan Connector (CPU\_FAN1)

PIN NO.	DESCRIPTION
1	GND
2	+12V
3	Rotation Signal
4	PWM Control Signal

**Table 7-7: Fan Connector (CPU\_FAN1) Pinouts**

## S19A/S24A-QM87i Marine Panel PC

### 7.2.7 Front Panel Connector (F\_PANEL1)

	PIN	DESCRIPTION		PIN	DESCRIPTION
Power LED	1	PWR_LED+	Speaker	2	SPKR+
	3	PWR_LED+	IPMI LED	4	IPMI ID_LED+
	5	PWR_LED-		6	IPMI ID_LED-
Power Button	7	PWR_BTN+	Speaker	8	SPKR-
	9	PWR_BTN-		10	N/C
HDD LED	11	HDD_LED+		12	RESET+
	13	HDD_LED-		14	RESET-

**Table 7-8: Front Panel Connector (F\_PANEL1) Pinouts**

### 7.2.8 IPMI LED Connector (IPMI\_LED1)

PIN NO.	DESCRIPTION
1	IPMI_LED+
2	IPMI_LED-

**Table 7-9: IPMI LED Connector (IPMI\_LED1) Pinouts**

### 7.2.9 LAN Active LED Connector (LAN\_ACT\_LED1)

PIN NO.	DESCRIPTION	PIN NO.	DESCRIPTION
1	LAN1_LINK_ACT-	2	V_3P3_LAN
3	LAN2_LINK_ACT-	4	+3.3A

**Table 7-10: LAN Active LED Connector (LAN\_ACT\_LED1)**

### 7.2.10 PCIe Mini Slots (MINI-PCIE1, MINI-PCIE2)

PIN NO.	DESCRIPTION	PIN NO.	DESCRIPTION
1	PCI_E_WAKE#	2	VCC3
3	N/C	4	GND
5	N/C	6	1.5V
7	N/C	8	N/C
9	GND	10	N/C

PIN NO.	DESCRIPTION	PIN NO.	DESCRIPTION
11	CLK-	12	N/C
13	CLK+	14	N/C
15	GND	16	N/C
17	PCIRST#	18	GND
19	N/C	20	VCC3
21	GND	22	PCIRST#
23	PERN2	24	3VDual
25	PERP2	26	GND
27	GND	28	1.5V
29	GND	30	SMBCLK
31	PETN2	32	SMBDATA
33	PETP2	34	GND
35	GND	36	USBD-
37	N/C	38	USBD+
39	N/C	40	GND
41	N/C	42	N/C
43	GND	44	N/C
45	N/C	46	N/C
47	N/C	48	1.5V
49	N/C	50	GND
51	N/C	52	VCC3

**Table 7-11: PCIe Mini Slots (MINI-PCIE1, MINI-PCIE2) Pinouts**

### 7.2.11 Power Connector (PWR1)

PIN NO.	DESCRIPTION	PIN NO.	DESCRIPTION
1	GND	2	GND
3	+12V	4	+12V

**Table 7-12: Power Connector (PWR1) Pinouts**

## S19A/S24A-QM87i Marine Panel PC

### 7.2.12 Power Button Connector (PWR\_BTN1)

PIN NO.	DESCRIPTION
1	PWRBTN_SW#
2	GND

**Table 7-13: Power Button Connector (PWR\_BTN1) Pinouts**

### 7.2.13 PS\_ON Connector (PS\_ON1)

PIN NO.	DESCRIPTION
1	5VSB
2	EC_PSON#
3	GND

**Table 7-14: PS\_ON Connector (PS\_ON1) Pinouts**

### 7.2.14 RS-232/422/485 Connector (COM2, COM3, COM4, COM5)

PIN NO.	RS-232	RS-422	RS-485
1	-NDCD	TX-	D-
2	-NDSR		
3	-NSIN	TX+	D+
4	-NRTS		
5	NSOUT	RX+	
6	-NCTS		
7	-NDTR	RX-	
8	-XRI		
9	GND		
10	GND		

**Table 7-15: RS-232/422/485 Connectors (COM2, COM3, COM4, COM5)**

### 7.2.15 SATA Connector (S\_ATA1)

PIN NO.	DESCRIPTION
1	GND
2	TX+

3	TX-
4	GND
5	RX-
6	RX+
7	GND

**Table 7-16: SATA Connector (S\_ATA1) Pinouts**

**7.2.16 SATA Connector (S\_ATA2)**

PIN NO.	DESCRIPTION
1	GND
2	TX+
3	TX-
4	GND
5	RX-
6	RX+
7	GND

**Table 7-17: SATA Connector (S\_ATA2) Pinouts**

**7.2.17 SATA Power Connector (SATA\_PWR1)**

Total +5V SATA power is 3A (SATA\_PWR1plus SATA\_PWR2)

Total +12V SATA power is 3A (SATA\_PWR1plus SATA\_PWR2)

PIN NO.	DESCRIPTION
1	+12V
2	GND
3	GND
4	+5V

**Table 7-18: SATA Power Connector (SATA\_PWR1) Pinouts**



## S19A/S24A-QM87i Marine Panel PC

### 7.2.18 SATA Power Connector (SATA\_PWR2)

PIN NO.	DESCRIPTION
1	+12V
2	GND
3	GND
4	+5V

**Table 7-19: SATA Power Connector (SATA\_PWR2) Pinouts**

### 7.2.19 SMBus Connector, EC (SMB1)

PIN NO.	DESCRIPTION
1	GND
2	SMB_DATA
3	SMB_CLK
4	+V5S

**Table 7-20: SMBus Connector, EC (SMB1)**

### 7.2.20 SPI Flash Connector (SPI1)

PIN NO.	DESCRIPTION
1	+V3.3M_SPI_CON
2	SPI_CS#0_CN
3	SPI_SO_SW
4	SPI_CLK_SW
5	SPI_SI_SW
6	GND

**Table 7-21: SPI Flash Connector (SPI1) Pinouts**

### 7.2.21 SPI Flash Connector, EC (CN2)

PIN NO.	DESCRIPTION
1	SMCLK1_EC
2	SMDAT1_EC

Table 7-22: SPI Flash Connector, EC (CN2)

### 7.2.22 TPM Connector (TPM1)

PIN NO.	DESCRIPTION	PIN NO.	DESCRIPTION
1	LCLK	2	GND
3	LFRAME#	4	KEY
5	LRERST#	6	+5V
7	LAD3	8	LAD2
9	+3V	10	LAD1
11	LAD0	12	GND
13	SCL	14	SDA
15	SB3V	16	SERIRQ
17	GND	18	GLKRUN#
19	LPCPD#	20	LDRQ#

Table 7-23: TPM Connector (TPM1) Pinouts

## 7.3 External Interface Panel Connectors

The table below lists the rear panel connectors on the S19A/S24A-QM87i motherboard. Pinouts of these connectors can be found in the following sections.

Connector	Type	Label
ATX/AT mode switch	Switch	J_ATXCTL1
CAN bus connector	6-pin terminal block	CAN1
Clear CMOS button	Push button	J_CMOS1
DVI and VGA combo connector	DVI-I 15-pin female D-sub	DVI_VGA1

## S19A/S24A-QM87i Marine Panel PC

Connector	Type	Label
HDMI connector	HDMI	HDMI1
Keyboard/mouse and USB 2.0 combo connector	PS/2 USB 2.0 port	K/B_USB1
GbE connectors	RJ-45	LAN1/2-CN1
RS-232 serial port	DB-9	COM1
USB 3.0 connectors	USB 3.0 port	USB3_CN1

**Table 7-24: Rear Panel Connectors**

### 7.3.1 CAN Bus Connector (CAN1)

PIN NO.	DESCRIPTION	PIN NO.	DESCRIPTION
1	CAN1H	2	CAN2H
3	CAN1L	4	CAN2L
5	GND_CAN1	6	GND_CAN2

**Table 7-25: CAN Bus Connector (CAN1) Pinouts**

### 7.3.2 DVI Connector (DVI)

PIN NO.	DESCRIPTION	PIN NO.	DESCRIPTION
1	DVI signal differential pair (2-)	2	DVI signal differential pair (2+)
3	GND	4	DVI signal differential pair (4-)
5	DVI signal differential pair (4+)	6	DDCLK
7	DDCDATA	8	N/C
9	DVI signal differential pair (1-)	10	DVI signal differential pair (1+)
11	GND	12	DVI signal differential pair (3-)
13	DVI signal differential pair (3+)	14	5V supply
15	GND	16	Hot plug detect
17	DVI signal differential pair (0-)	18	DVI signal differential pair (0+)
19	GND	20	DVI signal differential pair (5-)
21	DVI signal differential pair (5+)	22	GND
23	DVI CLK(+)	24	DVI CLK(-)

**Table 7-26: DVI Connector (DVI) Pinouts**

### 7.3.3 VGA Connector (VGA1)

PIN NO.	DESCRIPTION	PIN NO.	DESCRIPTION
1	RED	9	VCC
2	GREEN	10	GROUND
3	BLUE	11	NC
4	NC	12	DCCDA
5	GROUND	13	HSYNC
6	GROUND	14	VSYNC
7	GROUND	15	DCCCLK
8	GROUND		

**Table 7-27: VGA Connector (VGA1) Pinouts**

### 7.3.4 HDMI Connector (HDMI1)

PIN NO.	DESCRIPTION	PIN NO.	DESCRIPTION
1	HDMI_DATA2+	11	GND
2	GND	12	HDMI_CLK#
3	HDMI_DATA2#-	13	N/C
4	HDMI_DATA1+	14	N/C
5	GND	15	HDMI_SCL
6	HDMI_DATA1#-	16	HDMI_SDA
7	HDMI_DATA0+	17	GND
8	GND	18	+5VCC
9	HDMI_DATA0#-	19	HDMI_HPD
10	HDMI_CLK+		

**Table 7-28: HDMI Connector (HDMI1) Pinouts**

## S19A/S24A-QM87i Marine Panel PC

### 7.3.5 GbE Connectors (LAN1/2-CN1)

PIN NO.	DESCRIPTION	PIN NO.	DESCRIPTION
1	MDIA3-	5	MDIA2+
2	MDIA3+	6	MDIA1+
3	MDIA1-	7	MDIA0-
4	MDIA2-	8	MDIA0+

**Table 7-29: RJ-45 GbE Connector (LAN1/2-CN1) Pinouts**

### 7.3.6 RS-232 Serial Port (COM1)

PIN NO.	DESCRIPTION	PIN NO.	DESCRIPTION
1	DCD	2	RXD
3	TXD	4	DTR
5	GND	6	DSR
7	RTS	8	CTS
9	RI		

**Table 7-30: RS-232 Serial Port (COM1) Pinouts**

### 7.3.7 USB 2.0 Connectors (USB1)

PIN NO.	DESCRIPTION
1	VCC
2	USB_DATA-
3	USB_DATA+
4	GND

**Table 7-31: USB 2.0 Connector (USB1) Pinouts**

**7.3.8 USB 3.0 Connectors (USB3\_CN1)**

PIN NO.	DESCRIPTION	PIN NO.	DESCRIPTION
1	VCC	10	VCC
2	USB_DATA-	11	USB_DATA-
3	USB_DATA+	12	USB_DATA+
4	GND	13	GND
5	USB3_RX-	14	USB3_RX-
6	USB3_RX+	15	USB3_RX+
7	GND	16	GND
8	USB3_TX-	17	USB3_TX-
9	USB3_TX+	18	USB3_TX+

**Table 7-32: USB 3.0 Connector (USB3\_CN1) Pinouts**

Appendix

**A**

# Regulatory Compliance

---

**DECLARATION OF CONFORMITY**

This equipment is in conformity with the following EU directives:

- EMC Directive 2004/108/EC
- Low-Voltage Directive 2006/95/EC
- RoHS II Directive 2011/65/EU

If the user modifies and/or install other devices in the equipment, the CE conformity declaration may no longer apply.

If this equipment has telecommunications functionality, it also complies with the requirements of the R&TTE Directive 1999/5/EC.

---

English

IEI Integration Corp declares that this equipment is in compliance with the essential requirements and other relevant provisions of Directive 1999/5/EC.

---

Български [Bulgarian]

IEI Integration Corp. декларира, че този оборудване е в съответствие със съществените изисквания и другите приложими правила на Директива 1999/5/EC.

---

Česky [Czech]

IEI Integration Corp tímto prohlašuje, že tento zařizení je ve shodě se základními požadavky a dalšími příslušnými ustanoveními směrnice 1999/5/ES.

---

Dansk [Danish]

IEI Integration Corp erklærer herved, at følgende udstyr overholder de væsentlige krav og øvrige relevante krav i direktiv 1999/5/EF.

---

Deutsch [German]

IEI Integration Corp, erklärt dieses Gerät entspricht den grundlegenden Anforderungen und den weiteren entsprechenden Vorgaben der Richtlinie 1999/5/EU.

---

Eesti [Estonian]

IEI Integration Corp deklareerib seadme seadme vastavust direktiivi 1999/5/EÜ põhinõuetele ja nimetatud direktiivist tulenevatele teistele asjakohastele sätetele.

---



**S19A/S24A-QM87i Marine Panel PC**

---

**Español [Spanish]**

IEI Integration Corp declara que el equipo cumple con los requisitos esenciales y cualesquiera otras disposiciones aplicables o exigibles de la Directiva 1999/5/CE.

---

**Ελληνική [Greek]**

IEI Integration Corp ΔΗΛΩΝΕΙ ΟΤΙ ΕΞΟΠΛΙΣΜΟΣ ΣΥΜΜΟΡΦΩΝΕΤΑΙ ΠΡΟΣ ΤΙΣ ΟΥΣΙΩΔΕΙΣ ΑΠΑΙΤΗΣΕΙΣ ΚΑΙ ΤΙΣ ΛΟΙΠΕΣ ΣΧΕΤΙΚΕΣ ΔΙΑΤΑΞΕΙΣ ΤΗΣ ΟΔΗΓΙΑΣ 1999/5/EK.

---

**Français [French]**

IEI Integration Corp déclare que l'appareil est conforme aux exigences essentielles et aux autres dispositions pertinentes de la directive 1999/5/CE.

---

**Italiano [Italian]**

IEI Integration Corp dichiara che questo apparecchio è conforme ai requisiti essenziali ed alle altre disposizioni pertinenti stabilite dalla direttiva 1999/5/CE.

---

**Latviski [Latvian]**

IEI Integration Corp deklarē, ka iekārta atbilst būtiskajām prasībām un citiem ar to saistītajiem noteikumiem Direktīvas 1999/5/EK.

---

**Lietuvių [Lithuanian]**

IEI Integration Corp deklaruoja, kad šis įranga atitinka esminius reikalavimus ir kitas 1999/5/EB Direktyvos nuostatas.

---

**Nederlands [Dutch]**

IEI Integration Corp dat het toestel toestel in overeenstemming is met de essentiële eisen en de andere relevante bepalingen van richtlijn 1999/5/EG.

---

**Malti [Maltese]**

IEI Integration Corp jiddikjara li dan prodott jikkonforma mal-ħtiġijiet essenzjali u ma provvedimenti oħrajn relevanti li hemm fid-Dirrettiva 1999/5/EC.

---

**Magyar [Hungarian]**

IEI Integration Corp nyilatkozom, hogy a berendezés megfelel a vonatkozó alapvető követelményeknek és az 1999/5/EC irányelv egyéb előírásainak.

---

**Polski [Polish]**

IEI Integration Corp oświadcza, że wyrobu jest zgodny z zasadniczymi wymogami oraz pozostałymi stosownymi postanowieniami Dyrektywy 1999/5/EC.

---

**Português [Portuguese]**

IEI Integration Corp declara que este equipamento está conforme com os requisitos essenciais e outras disposições da Diretiva 1999/5/CE.

---

---

Româna [Romanian]

IEI Integration Corp declară că acest echipament este în conformitate cu cerințele esențiale și cu celelalte prevederi relevante ale Directivei 1999/5/CE.

---

Slovensko [Slovenian]

IEI Integration Corp izjavlja, da je ta opreme v skladu z bistvenimi zahtevami in ostalimi relevantnimi določili direktive 1999/5/ES.

---

Slovensky [Slovak]

IEI Integration Corp týmto vyhlasuje, že zariadenia spĺňa základné požiadavky a všetky príslušné ustanovenia Smernice 1999/5/ES.

---

Suomi [Finnish]

IEI Integration Corp vakuuttaa täten että laitteet on direktiivin 1999/5/EY oleellisten vaatimusten ja sitä koskevien direktiivin muiden ehtojen mukainen.

---

Svenska [Swedish]

IEI Integration Corp förklarar att denna utrustningstyp står i överensstämmelse med de väsentliga egenskapskrav och övriga relevanta bestämmelser som framgår av direktiv 1999/5/EG.

---

## S19A/S24A-QM87i Marine Panel PC

### FCC WARNING



This equipment complies with Part 15 of the FCC Rules. Operation is subject to the following two conditions:

- This device may not cause harmful interference, and
- This device must accept any interference received, including interference that may cause undesired operation.

This equipment has been tested and found to comply with the limits for a Class A digital device, pursuant to part 15 of the FCC Rules. These limits are designed to provide reasonable protection against harmful interference when the equipment is operated in a commercial environment. This equipment generates, uses, and can radiate radio frequency energy and, if not installed and used in accordance with the instruction manual, may cause harmful interference to radio communications. Operation of this equipment in a residential area is likely to cause harmful interference in which case the user will be required to correct the interference at his own expense.

Appendix

**B**

# Safety Precautions

---

## S19A/S24A-QM87i Marine Panel PC

---



### WARNING:

The precautions outlined in this chapter should be strictly followed. Failure to follow these precautions may result in permanent damage to the S19A/S24A-QM87i.

---

## B.1 Safety Precautions

Please follow the safety precautions outlined in the sections that follow:

### B.1.1 General Safety Precautions

Please ensure the following safety precautions are adhered to at all times.

- **Follow the electrostatic precautions** outlined below whenever the S19A/S24A-QM87i is opened.
- **Make sure the power is turned off and the power cord is disconnected** whenever the S19A/S24A-QM87i is being installed, moved or modified.
- **Do not apply voltage levels that exceed the specified voltage range.** Doing so may cause fire and/or an electrical shock.
- **Electric shocks can occur** if the S19A/S24A-QM87i chassis is opened when the S19A/S24A-QM87i is running.
- **Do not drop or insert any objects** into the ventilation openings of the S19A/S24A-QM87i.
- **If considerable amounts of dust, water, or fluids enter the S19A/S24A-QM87i**, turn off the power supply immediately, unplug the power cord, and contact the S19A/S24A-QM87i vendor.
- **DO NOT:**
  - Drop the S19A/S24A-QM87i against a hard surface.
  - In a site where the ambient temperature exceeds the rated temperature

### B.1.2 Anti-static Precautions

---

**WARNING:**

Failure to take ESD precautions during the installation of the S19A/S24A-QM87i may result in permanent damage to the S19A/S24A-QM87i and severe injury to the user.

---

Electrostatic discharge (ESD) can cause serious damage to electronic components, including the S19A/S24A-QM87i. Dry climates are especially susceptible to ESD. It is therefore critical that whenever the S19A/S24A-QM87i is opened and any of the electrical components are handled, the following anti-static precautions are strictly adhered to.

- ***Wear an anti-static wristband:*** Wearing a simple anti-static wristband can help to prevent ESD from damaging any electrical component.
- ***Self-grounding:*** Before handling any electrical component, touch any grounded conducting material. During the time the electrical component is handled, frequently touch any conducting materials that are connected to the ground.
- ***Use an anti-static pad:*** When configuring or working with an electrical component, place it on an anti-static pad. This reduces the possibility of ESD damage.
- ***Only handle the edges of the electrical component:*** When handling the electrical component, hold the electrical component by its edges.

## S19A/S24A-QM87i Marine Panel PC

### B.1.3 Product Disposal

---



#### CAUTION:

Risk of explosion if battery is replaced by and incorrect type. Only certified engineers should replace the on-board battery.

Dispose of used batteries according to instructions and local regulations.

---

- Outside the European Union - If you wish to dispose of used electrical and electronic products outside the European Union, please contact your local authority so as to comply with the correct disposal method.
- Within the European Union:

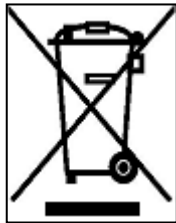

EU-wide legislation, as implemented in each Member State, requires that waste electrical and electronic products carrying the mark (left) must be disposed of separately from normal household waste. This includes monitors and electrical accessories, such as signal cables or power cords. When you need to dispose of your display products, please follow the guidance of your local authority, or ask the shop where you purchased the product. The mark on electrical and electronic products only applies to the current European Union Member States.

Please follow the national guidelines for electrical and electronic product disposal.

## B.2 Maintenance and Cleaning Precautions

When maintaining or cleaning the S19A/S24A-QM87i, please follow the guidelines below.

### B.2.1 Maintenance and Cleaning

Prior to cleaning any part or component of the S19A/S24A-QM87i, please read the details below.

- The interior of the S19A/S24A-QM87i does not require cleaning. Keep fluids away from the S19A/S24A-QM87i interior.
- Be cautious of all small removable components when vacuuming the S19A/S24A-QM87i.
- Turn the S19A/S24A-QM87i off before cleaning the S19A/S24A-QM87i.
- Never drop any objects or liquids through the openings of the S19A/S24A-QM87i.
- Be cautious of any possible allergic reactions to solvents or chemicals used when cleaning the S19A/S24A-QM87i.
- Avoid eating, drinking and smoking within vicinity of the S19A/S24A-QM87i.

### B.2.2 Cleaning Tools

Some components in the S19A/S24A-QM87i may only be cleaned using a product specifically designed for the purpose. In such case, the product will be explicitly mentioned in the cleaning tips. Below is a list of items to use when cleaning the S19A/S24A-QM87i.

- **Cloth** – Although paper towels or tissues can be used, a soft, clean piece of cloth is recommended when cleaning the S19A/S24A-QM87i.
- **Water or rubbing alcohol** – A cloth moistened with water or rubbing alcohol can be used to clean the S19A/S24A-QM87i.
- **Using solvents** – The use of solvents is not recommended when cleaning the S19A/S24A-QM87i as they may damage the plastic parts.
- **Vacuum cleaner** – Using a vacuum specifically designed for computers is one of the best methods of cleaning the S19A/S24A-QM87i. Dust and dirt can restrict the airflow in the S19A/S24A-QM87i and cause its circuitry to corrode.
- **Cotton swabs** - Cotton swaps moistened with rubbing alcohol or water are excellent tools for wiping hard to reach areas.
- **Foam swabs** - Whenever possible, it is best to use lint free swabs such as foam swabs for cleaning.



Appendix

C

# BIOS Menu Options

---

## C.1 BIOS Configuration Options

Below is a list of BIOS configuration options described in **Chapter 4**.

<input type="checkbox"/>	<b>System Date [xx/xx/xx]</b> .....	<b>52</b>
<input type="checkbox"/>	<b>System Time [xx:xx:xx]</b> .....	<b>52</b>
<input type="checkbox"/>	<b>ACPI Sleep State [S1 only (CPU Stop Clock)]</b> .....	<b>53</b>
<input type="checkbox"/>	<b>Wake System with Fixed Time [Disabled]</b> .....	<b>54</b>
<input type="checkbox"/>	<b>Security Device Support [Disable]</b> .....	<b>56</b>
<input type="checkbox"/>	<b>Hyper-threading [Disabled]</b> .....	<b>57</b>
<input type="checkbox"/>	<b>Active Processor Cores [All]</b> .....	<b>57</b>
<input type="checkbox"/>	<b>Intel Virtualization Technology [Disabled]</b> .....	<b>58</b>
<input type="checkbox"/>	<b>EIST [Enabled]</b> .....	<b>58</b>
<input type="checkbox"/>	<b>Intel TXT (LT) Support [Disabled]</b> .....	<b>58</b>
<input type="checkbox"/>	<b>SATA Controller(s) [Enabled]</b> .....	<b>59</b>
<input type="checkbox"/>	<b>SATA Mode Selection [IDE]</b> .....	<b>59</b>
<input type="checkbox"/>	<b>Intel(R) Rapid Start Technology [Disabled]</b> .....	<b>60</b>
<input type="checkbox"/>	<b>Intel AMT [Enabled]</b> .....	<b>61</b>
<input type="checkbox"/>	<b>Un-Configure ME [Disabled]</b> .....	<b>61</b>
<input type="checkbox"/>	<b>USB Devices</b> .....	<b>62</b>
<input type="checkbox"/>	<b>Legacy USB Support [Enabled]</b> .....	<b>62</b>
<input type="checkbox"/>	<b>H/W Monitor</b> .....	<b>63</b>
<input type="checkbox"/>	<b>Serial Port [Enabled]</b> .....	<b>65</b>
<input type="checkbox"/>	<b>Change Settings [Auto]</b> .....	<b>65</b>
<input type="checkbox"/>	<b>Serial Port [Enabled]</b> .....	<b>66</b>
<input type="checkbox"/>	<b>Change Settings [Auto]</b> .....	<b>66</b>
<input type="checkbox"/>	<b>Serial Port Mode [RS485]</b> .....	<b>67</b>
<input type="checkbox"/>	<b>Serial Port [Enabled]</b> .....	<b>67</b>
<input type="checkbox"/>	<b>Change Settings [Auto]</b> .....	<b>67</b>
<input type="checkbox"/>	<b>Serial Port Mode [RS485]</b> .....	<b>68</b>
<input type="checkbox"/>	<b>Serial Port [Enabled]</b> .....	<b>68</b>
<input type="checkbox"/>	<b>Change Settings [Auto]</b> .....	<b>68</b>
<input type="checkbox"/>	<b>Serial Port Mode [RS485]</b> .....	<b>69</b>
<input type="checkbox"/>	<b>Serial Port [Enabled]</b> .....	<b>69</b>
<input type="checkbox"/>	<b>Change Settings [Auto]</b> .....	<b>69</b>

## S19A/S24A-QM87i Marine Panel PC

<input type="checkbox"/>	Serial Port Mode [RS485] .....	70
<input type="checkbox"/>	Console Redirection [Enabled].....	71
<input type="checkbox"/>	Auto Recovery Function [Disabled].....	72
<input type="checkbox"/>	Restore on AC Power Loss [Last State].....	74
<input type="checkbox"/>	Azalia (HD Audio) [Enabled] .....	74
<input type="checkbox"/>	Serial IRQ Mode [Continuous].....	74
<input type="checkbox"/>	Power Saving Function (ERP) [Disabled].....	74
<input type="checkbox"/>	VT-d [Disabled].....	75
<input type="checkbox"/>	Primary Display [Auto] .....	76
<input type="checkbox"/>	DVMT Pre-Allocated [256M] .....	76
<input type="checkbox"/>	DVMT Total Gfx Mem [256M].....	77
<input type="checkbox"/>	Primary IGFX Boot Display [VBIOS Default] .....	77
<input type="checkbox"/>	Bootup NumLock State [On].....	79
<input type="checkbox"/>	Quiet Boot [Enabled] .....	79
<input type="checkbox"/>	Option ROM Messages [Force BIOS].....	79
<input type="checkbox"/>	Launch PXE OpROM [Disabled] .....	80
<input type="checkbox"/>	UEFI Boot [Disabled] .....	80
<input type="checkbox"/>	Administrator Password .....	80
<input type="checkbox"/>	User Password .....	81
<input type="checkbox"/>	Save Changes and Reset .....	81
<input type="checkbox"/>	Discard Changes and Reset .....	81
<input type="checkbox"/>	Restore Defaults .....	81
<input type="checkbox"/>	Save as User Defaults .....	82
<input type="checkbox"/>	Restore User Defaults .....	82
<input type="checkbox"/>	SEL Components [Enabled].....	83
<input type="checkbox"/>	Erase SEL [No] .....	83
<input type="checkbox"/>	When SEL is Full [Do Nothing].....	84
<input type="checkbox"/>	Log EFI Status Codes [Both] .....	84
<input type="checkbox"/>	Configuration Address source [Unspecified] .....	85

Appendix

**D**

# Watchdog Timer

---

**NOTE:**

The following discussion applies to DOS environment. IEI support is contacted or the IEI website visited for specific drivers for more sophisticated operating systems, e.g., Windows and Linux.

The Watchdog Timer is provided to ensure that standalone systems can always recover from catastrophic conditions that cause the CPU to crash. This condition may have occurred by external EMI or a software bug. When the CPU stops working correctly, Watchdog Timer either performs a hardware reset (cold boot) or a Non-Maskable Interrupt (NMI) to bring the system back to a known state.

A BIOS function call (INT 15H) is used to control the Watchdog Timer:

**INT 15H:**

<b>AH – 6FH Sub-function:</b>	
AL – 2:	Sets the Watchdog Timer's period.
BL:	Time-out value (Its unit-second is dependent on the item "Watchdog Timer unit select" in CMOS setup).

**Table D-1: AH-6FH Sub-function**

Call sub-function 2 to set the time-out period of Watchdog Timer first. If the time-out value is not zero, the Watchdog Timer starts counting down. While the timer value reaches zero, the system resets. To ensure that this reset condition does not occur, calling sub-function 2 must periodically refresh the Watchdog Timer. However, the Watchdog timer is disabled if the time-out value is set to zero.

A tolerance of at least 10% must be maintained to avoid unknown routines within the operating system (DOS), such as disk I/O that can be very time-consuming.

**NOTE:**

When exiting a program it is necessary to disable the Watchdog Timer, otherwise the system resets.

**Example program:**

```
; INITIAL TIMER PERIOD COUNTER
;
W_LOOP:

    MOV     AX, 6F02H      ;setting the time-out value
    MOV     BL, 30        ;time-out value is 48 seconds
    INT     15H

;
; ADD THE APPLICATION PROGRAM HERE
;

    CMP     EXIT_AP, 1    ;is the application over?
    JNE     W_LOOP       ;No, restart the application

    MOV     AX, 6F02H     ;disable Watchdog Timer
    MOV     BL, 0        ;
    INT     15H

;
; EXIT ;
```

Appendix

E

# Hazardous Materials Disclosure

---

The details provided in this appendix are to ensure that the product is compliant with the Peoples Republic of China (China) RoHS standards. The table below acknowledges the presences of small quantities of certain materials in the product, and is applicable to China RoHS only.

A label will be placed on each product to indicate the estimated “Environmentally Friendly Use Period” (EFUP). This is an estimate of the number of years that these substances would “not leak out or undergo abrupt change.” This product may contain replaceable sub-assemblies/components which have a shorter EFUP such as batteries and lamps. These components will be separately marked.

Please refer to the following table.

Part Name	Toxic or Hazardous Substances and Elements					
	Lead (Pb)	Mercury (Hg)	Cadmium (Cd)	Hexavalent Chromium (CR(VI))	Polybrominated Biphenyls (PBB)	Polybrominated Diphenyl Ethers (PBDE)
Housing	O	O	O	O	O	O
Display	O	O	O	O	O	O
Printed Circuit Board	O	O	O	O	O	O
Metal Fasteners	O	O	O	O	O	O
Cable Assembly	O	O	O	O	O	O
Fan Assembly	O	O	O	O	O	O
Power Supply Assemblies	O	O	O	O	O	O
Battery	O	O	O	O	O	O

O: This toxic or hazardous substance is contained in all of the homogeneous materials for the part is below the limit requirement in SJ/T11363-2006 (now replaced by GB/T 26572-2011).

X: This toxic or hazardous substance is contained in at least one of the homogeneous materials for this part is above the limit requirement in SJ/T11363-2006 (now replaced by GB/T 26572-2011).



## S19A/S24A-QM87i Marine Panel PC

此附件旨在确保本产品符合中国 RoHS 标准。以下表格标示此产品中某有毒物质的含量符合中国 RoHS 标准规定的限量要求。

本产品上会附有“环境友好使用期限”的标签，此期限是估算这些物质“不会有泄漏或突变”的年限。本产品可能包含有较短的环境友好使用期限的可替换元件，像是电池或灯管，这些元件将会单独标示出来。

部件名称	有毒有害物质或元素					
	铅 (Pb)	汞 (Hg)	镉 (Cd)	六价铬 (CR(VI))	多溴联苯 (PBB)	多溴二苯 醚 (PBDE)
壳体	○	○	○	○	○	○
显示	○	○	○	○	○	○
印刷电路板	○	○	○	○	○	○
金属螺帽	○	○	○	○	○	○
电缆组装	○	○	○	○	○	○
风扇组装	○	○	○	○	○	○
电力供应组装	○	○	○	○	○	○
电池	○	○	○	○	○	○

○: 表示该有毒有害物质在该部件所有物质材料中的含量均在 SJ/T 11363-2006 (现由 GB/T 26572-2011 取代) 标准规定的限量要求以下。

X: 表示该有毒有害物质至少在该部件的某一均质材料中的含量超出 SJ/T 11363-2006 (现由 GB/T 26572-2011 取代) 标准规定的限量要求。